

# Sign Crew Field Book

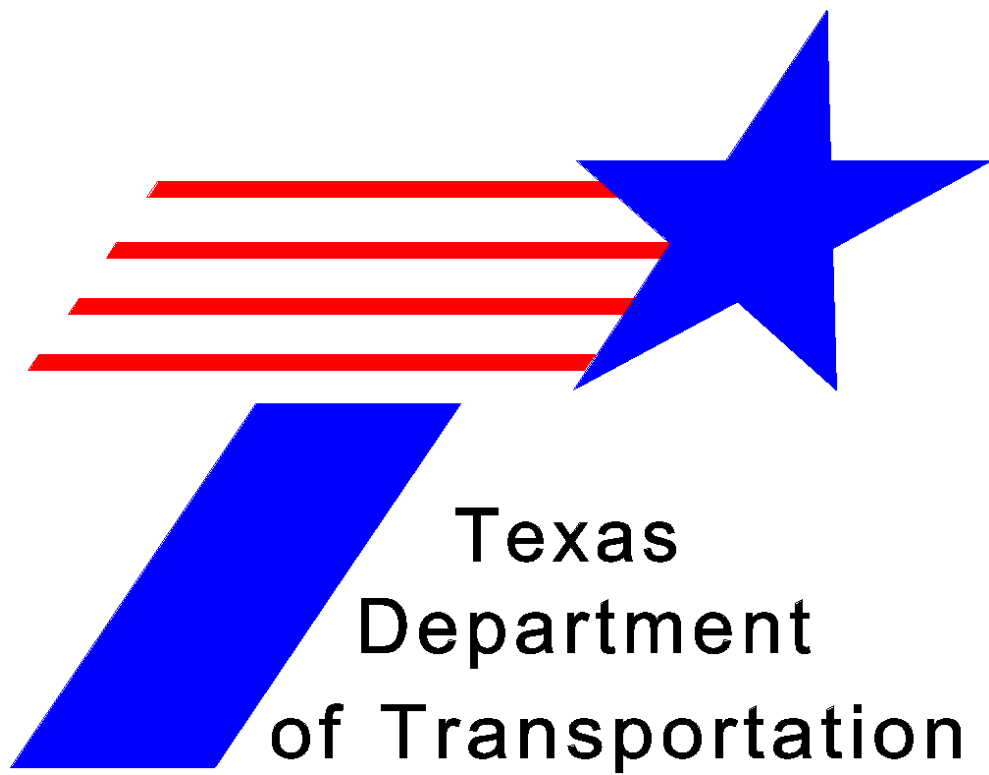

Revised October 2009

© 2009 by Texas Department of Transportation  
(512) 302-2453 all rights reserved

## **Manual Notice 2009-1**

**From:** Carol T. Rawson, P.E., Traffic Operations

**Manual:** *Sign Crew Field Book*

**Effective Date:** October 01, 2009

### **Purpose**

The purpose of this manual revision is to introduce a new manual, the *Sign Crew Field Book*, to the Texas Department of Transportation (TxDOT) Online Manual System. Prior to the publication of the first edition of the *Sign Crew Field Book* in 1997, which has been available only in hard-copy format, field sign crews in TxDOT districts had to rely on the *Texas Manual on Uniform Traffic Control Devices* (TMUTCD), the TxDOT Traffic Control Standard Sheets, or instructions from supervisors to determine the most effective placement of traffic signs on conventional highways. However, as these documents primarily addressed sign design and selection, with less detailed information on sign placement, the *Sign Crew Field Book* was developed to provide district sign crews with information beyond that contained in the TMUTCD or the TxDOT Traffic Engineering Standard Sheets to improve statewide uniformity in the placement of traffic signs.

### **Contents**

The contents of the *Sign Crew Field Book* have been revised from the existing hard-copy edition of the manual to reflect new and updated policies and standards of TxDOT and the Federal Highway Administration (FHWA) pertaining to the placement of signs, mailboxes and other devices on highway right-of-way. Because this field book is specifically intended for use by district sign crews, it emphasizes the use of tables and graphics and contains only limited amounts of text.

### **Contact**

Address questions concerning information contained in this manual to Michael Chacon of the TxDOT Traffic Operations Division, 512-416-3120.

### **Archives**

Since this is a new online manual, there are no previous versions in archives.

---

# Table of Contents

## Chapter 1 — Introduction

Section 1 — Overview .....	1-2
Introduction .....	1-2
Section 2 — Background Information .....	1-3
Purpose of Field Book .....	1-3
Status of Field Book .....	1-3
Organization of the Sign Crew Field Book .....	1-3
Relationship to Other TxDOT Documents .....	1-4
Use of Signs in Figures .....	1-4
Relationship of Intersection Illustrations to Actual Intersections .....	1-5
History of the Sign Crew Field Book .....	1-5
Helpful Information for First Time Users .....	1-5

## Chapter 2 — Warning Signs

Section 1 — Overview .....	2-2
Introduction .....	2-2
Section 2 — Warning Sign Advance Placement .....	2-3
Introduction .....	2-3
Advance Placement Condition Descriptions .....	2-3
Relation Between Minimum Distances and Sign Crew Field Book Distance .....	2-3
Advance Placement Distance for Warning Signs .....	2-4
Conditions Associated with Specific Warning Signs .....	2-5
Section 3 — Watch for Ice on Bridge Sign .....	2-7
Introduction .....	2-7
Placement for Watch for Ice on Bridge Sign .....	2-7
Sign Display Schedule .....	2-7

## Chapter 3 — Types and Uses of Guide Signs

Section 1 — Overview .....	3-2
Introduction .....	3-2
Section 2 — Guide Sign Components .....	3-3
Introduction .....	3-3
Route Signs (Texas MUTCD 2D.10 and 2D.11) .....	3-4
Junction Sign (Texas MUTCD 2D.13 and 2D.14) .....	3-7
Cardinal Direction Auxiliary Signs (Texas MUTCD 2D.15) .....	3-9
Arrow Signs (Texas MUTCD 2D.25 and 2D.26) .....	3-11
Double Arrow Sign .....	3-12
Special Design for Wide Directional Arrow Auxiliary Sign .....	3-13

---

Other Auxiliary Signs (Texas MUTCD, Section 2D.16 to 2D.24) . . . . .	3-14
Section 3 — Arrangement of Components . . . . .	3-15
Introduction (Texas MUTCD, Section 2D.27) . . . . .	3-15
Guide Sign Units . . . . .	3-15
Arrangement Hierarchy . . . . .	3-16
Arrangement Pattern . . . . .	3-16
Arrangement by Direction . . . . .	3-19
Arrangement by Class of Highway . . . . .	3-19
Arrangement by Highway Number . . . . .	3-19
Examples of Assembly Arrangements. . . . .	3-20
Layout Dimensions for Assemblies. . . . .	3-23
Route Sign Assembly Layout Flow Chart . . . . .	3-24
Section 4 — Guide Sign Assemblies . . . . .	3-29
Introduction . . . . .	3-29
Junction Assembly (Texas MUTCD Section 2D.28) . . . . .	3-30
Advance Route Turn Assembly (Texas MUTCD Section 2D.29) . . . . .	3-31
Directional Assembly (Texas MUTCD Section 2D.30) . . . . .	3-33
Confirming or Reassurance Assembly (Texas MUTCD Section 2D.31) . . . . .	3-34
Trailblazer Assembly (Texas MUTCD Section 2D.32) . . . . .	3-35
Texas Reference Marker Assembly. . . . .	3-36
Section 5 — Stand-Alone Signs . . . . .	3-38
Introduction . . . . .	3-38
Destination Signs (Texas MUTCD Section 2D.33, 2D.34 and 2D.35). . . . .	3-39
Distance Signs (Texas MUTCD Section 2D.33, 2D.36 and 2D.37) . . . . .	3-40

**Chapter 4 — Lateral Placement and Height**

Section 1 — Overview . . . . .	4-2
Introduction . . . . .	4-2
Terminology Used in the Field Book . . . . .	4-2
Section 2 — Lateral Placement. . . . .	4-4
Introduction . . . . .	4-4
Locating Sign Posts Close to One Another . . . . .	4-4
Lateral Placement . . . . .	4-5
Section 3 — Lateral Placement at Intersections . . . . .	4-9
Introduction . . . . .	4-9
Section 4 — Sign Height. . . . .	4-15
Introduction . . . . .	4-15
Height of Signs and Sign Assemblies . . . . .	4-15

---

## **Chapter 5 — Approach Placement**

Section 1 — Overview .....	5-2
Introduction .....	5-2
Section 2 — Basic Placement Considerations .....	5-3
Introduction .....	5-3
Convention Used in Illustrations .....	5-4
Effect of Speed on Placement Distances .....	5-7
Approach Placement Illustrations .....	5-8
Section 3 — 3-Leg T Intersection Illustrations .....	5-10
Introduction .....	5-10
Section 4 — 3-Leg Side Intersection Illustrations .....	5-17
Introduction .....	5-17
Section 5 — 4-Leg Intersection Illustrations .....	5-25
Introduction .....	5-25

## **Chapter 6 — Departure Placement**

Section 1 — Overview .....	6-2
Introduction .....	6-2
Section 2 — Basic Departure Placement Considerations .....	6-3
Introduction .....	6-3
Distance Between Departure Signs .....	6-3
Effect of Speed on Placement Distances .....	6-3
No Sign Zone .....	6-4
Section 3 — Intersection Departure Illustrations .....	6-6
Introduction .....	6-6

## **Chapter 7 — Special Signing Situations**

Section 1 — Overview .....	7-2
Introduction .....	7-2
Section 2 — Divided Highway Intersections and Crossovers .....	7-3
Introduction .....	7-3
Median Width .....	7-3
Markings for Divided Highway Intersections and Crossovers .....	7-4
Delineation for Divided Highway Intersections and Crossovers .....	7-4
Divided Highway Intersections .....	7-4
Crossovers .....	7-12
Section 3 — Overlapping Routes .....	7-17
Introduction .....	7-17
Section 4 — Road Ends .....	7-19
Introduction .....	7-19

---

Road Ends Situation . . . . .	7-19
Section 5 — Interchange Applications . . . . .	7-21
Introduction . . . . .	7-21
Interchanges . . . . .	7-21
Frontage Roads . . . . .	7-21
Section 6 — Lane Drop Applications . . . . .	7-28
Lane Drop at No Control Intersections . . . . .	7-28

**Chapter 8 — Roadside Markers**

Section 1 — Overview . . . . .	8-2
Introduction . . . . .	8-2
Section 2 — Object Markers . . . . .	8-3
Introduction . . . . .	8-3
Types of Object Markers (Texas MUTCD, Section 3C.01) . . . . .	8-4
End of Roadway Marker (Texas MUTCD, Section 3C.04) . . . . .	8-6
Omni-Directional Sign Post Wrap . . . . .	8-6
Application of Object Markers (Texas MUTCD, Section 3C.02 and 3C.03) . . . . .	8-7
Section 3 — Delineators . . . . .	8-8
Introduction . . . . .	8-8
Delineator Design (Texas MUTCD, Section 3D.02) . . . . .	8-8
Delineator Application (Texas MUTCD, Section 3D.03) . . . . .	8-9
Delineator Placement . . . . .	8-10
Delineation Spacing . . . . .	8-11
Delineation for Divided Highway Intersections and Crossovers . . . . .	8-14
Section 4 — Barrier Reflectors . . . . .	8-15
Introduction . . . . .	8-15
Barrier Reflector Design . . . . .	8-15
Barrier Reflector Application . . . . .	8-15
Barrier Reflector Placement . . . . .	8-16
Barrier Reflector Spacing . . . . .	8-17
Section 5 — Applications . . . . .	8-18
Introduction . . . . .	8-18
Application Illustrations . . . . .	8-18

**Chapter 9 — Mailboxes**

Section 1 — Overview . . . . .	9-2
Introduction . . . . .	9-2
Section 2 — Types of Mailboxes and Installations . . . . .	9-3
Introduction . . . . .	9-3
Types of Mailboxes . . . . .	9-3

---

Types of Mailbox Installations . . . . .	9-3
Section 3 — Mailbox Placement Considerations . . . . .	9-5
Introduction . . . . .	9-5
Placement Adjacent to Paved (All-Weather) Surface . . . . .	9-5
Longitudinal Placement . . . . .	9-5
Lateral Offset from Access Point . . . . .	9-8
Height . . . . .	9-9
Section 4 — Mailbox Hardware . . . . .	9-10
Introduction . . . . .	9-10
Types of Supports . . . . .	9-10
Types of Foundations . . . . .	9-12
Mailbox Bracket . . . . .	9-13
Section 5 — Mailbox Installation . . . . .	9-17
Single Mailbox Installation . . . . .	9-17
Double Mailbox Installation . . . . .	9-18
Multiple Mailbox Support . . . . .	9-19
Section 6 — Mailbox Attachments . . . . .	9-20
Introduction . . . . .	9-20
Object Markers on Mailbox Supports . . . . .	9-20
Emergency Location Number . . . . .	9-22
Newspaper Receptacle . . . . .	9-22
Section 7 — Mailbox Compliance . . . . .	9-24
Introduction . . . . .	9-24
Example Letter to Box Owners . . . . .	9-24

---

## List of Figures

Fig. 3-1 – Types of Route Sign Mounts .....	3-4
Fig. 3-2 – Route Signs for Independent Mounting .....	3-5
Fig. 3-3 – Route Signs for Guide Sign Mounting .....	3-6
Fig. 3-4 – Junction Sign (M2-1) .....	3-7
Fig. 3-5 – Junction Combination Sign .....	3-8
Fig. 3-6 – Cardinal Direction Signs .....	3-9
Fig. 3-7 – Relation between Cardinal Direction and Compass Direction .....	3-10
Fig. 3-8 – Assigning Cardinal Direction for a Non-Interstate Loop Route .....	3-10
Fig. 3-9 – Advance Turn Arrow Signs .....	3-11
Fig. 3-10 – Directional Arrow Signs .....	3-11
Fig. 3-11 – Use of Double-Headed Arrow in Directional Assembly .....	3-12
Fig. 3-12 – Extra Wide Directional Arrow Sign (M6-1T) .....	3-13
Fig. 3-13 – Lane Use Auxiliary Signs .....	3-13
Fig. 3-14 – Other Auxiliary Signs .....	3-14
Fig. 3-15 – Examples of a Guide Sign Unit .....	3-16
Fig. 3-16 – Horizontal Arrangement .....	3-18
Fig. 3-17 – Vertical Arrangement .....	3-18
Fig. 3-18 – Combination Arrangement .....	3-18
Fig. 3-19 – Route Sign Assembly for Intersection with Two Route Signs .....	3-20
Fig. 3-20 – Route Sign Assembly for Intersection with Three Route Signs .....	3-21
Fig. 3-21 – Route Sign Assembly for Intersection with Four Route Signs .....	3-22
Fig. 3-22 – Layout Dimensions for Assemblies .....	3-23
Fig. 3-23 – Route Sign Assembly Layout Master Flow Chart .....	3-24
Fig. 3-24 – Route Sign Assembly Layout - Highway with One Direction .....	3-25
Fig. 3-25 – Route Sign Assembly Layout - Highway with Two Directions .....	3-26
Fig. 3-26 – Route Sign Assembly Layout - Highway with Three Directions, Part 1 .....	3-27
Fig. 3-27 – Route Sign Assembly Layout - Highway with Three Directions, Part 2 .....	3-28
Fig. 3-28 – Typical Junction Assemblies .....	3-30
Fig. 3-29 – Advance Route Turn Sign Assembly .....	3-31
Fig. 3-30 – Required Applications of Advance Route Turn Assembly .....	3-32
Fig. 3-31 – Directional Assembly .....	3-33
Fig. 3-32 – Confirming or Reassurance Assembly .....	3-34
Fig. 3-33 – Trailblazer Assembly .....	3-35
Fig. 3-34 – Texas Reference Marker Assembly .....	3-37
Fig. 3-35 – Destination Signs .....	3-39
Fig. 3-36 – Distance Signs .....	3-40
Fig. 4-1 – Illustration of Terminology .....	4-3
Fig. 4-2 – Placement of Signs within 7 ft Circle .....	4-4
Fig. 4-3 – Lateral Sign Placement with No Shoulder or Narrow Shoulder .....	4-5
Fig. 4-4 – Lateral Sign Placement with Wide Shoulder .....	4-6
Fig. 4-5 – Lateral Sign Placement with Guardrail .....	4-6
Fig. 4-6 – Lateral Sign Placement with Curb and Gutter .....	4-7
Fig. 4-7 – Lateral Sign Placement with Raised Island .....	4-7
Fig. 4-8 – Lateral Sign Placement in Restricted Right-of-Way .....	4-8



---

Fig. 4-9 – Lateral Sign Placement between Two Roadways . . . . .	4-8
Fig. 4-10 – Stop/Yield Sign Lateral Placement at a Channelized Intersection. . . . .	4-10
Fig. 4-11 – Stop/Yield Sign Lateral Placement at an Intersection with Divisional Island . . . . .	4-11
Fig. 4-12 – Stop/Yield Sign Lateral Placement at a Wide-Throat Intersection . . . . .	4-12
Fig. 4-13 – Keep Right Sign Lateral Placement on a Divisional Island . . . . .	4-13
Fig. 4-14 – Placement of Large Arrow Panel . . . . .	4-14
Fig. 4-15 – Sign Height on Front Slope . . . . .	4-15
Fig. 4-16 – Sign Height on Back Slope . . . . .	4-16
Fig. 4-17 – Sign Height for Installations with a Supplemental Plaque or Secondary Sign . . . . .	4-16
Fig. 4-18 – Sign Height on Curb and Gutter or Raised Island . . . . .	4-17
Fig. 4-19 – Sign Height for Large Sign with Two or More Posts . . . . .	4-17
Fig. 4-20 – Sign Height between Main Lanes and Frontage Road. . . . .	4-18
Fig. 4-21 – Height for Texas Reference Marker Assembly . . . . .	4-18
Fig. 4-22 – Height for Reference Location Signs and Chevron Signs . . . . .	4-19
Fig. 5-1 – Example of Symbol Box . . . . .	5-4
Fig. 5-2 – Convention for Sign Placement Distances on High Speed Approach . . . . .	5-5
Fig. 5-3 – Convention for Sign Placement Distances on Low Speed Approach . . . . .	5-6
Fig. 5-4 – 3-Leg T, 1 Approach Lane, Stop Control, Approach Route Goes Left . . . . .	5-11
Fig. 5-5 – 3-Leg T, 1 Approach Lane with Free Right Turn, Stop Control, Approach Goes Left	5-12
Fig. 5-6 – 3-Leg T, 1 Approach Lane, Stop Control, Approach Route Ends . . . . .	5-13
Fig. 5-7 – 3-Leg T, 1 Approach Lane, Signal Control, Approach Route Goes Right . . . . .	5-14
Fig. 5-8 – 3-Leg T, 1 Approach Lane, Stop Control, Approach Routes Go Left and Right . . . . .	5-15
Fig. 5-9 – 3-Leg T, 2 Approach Lanes with Dual-Left, Signal Control, Approach Route Goes Right	5-16
Fig. 5-10 – 3-Leg Side, 1 Approach Lane, No Control, Approach Routes Go Through . . . . .	5-18
Fig. 5-11 – 3-Leg Side, 1 Approach Lane, No Control, Approach Routes Go Through & Left . . . . .	5-19
Fig. 5-12 – 3-Leg Side, 1 Approach + 1 LT, No Control, Approach Routes Go Through & Left	5-20
Fig. 5-13 – 3-Leg Side, 2 Approach Lanes, No Control, Approach Routes Go Through & Left	5-21
Fig. 5-14 – 3-Leg Side, 1 Approach Lane, Signal Control, Approach Route Goes Through. . . . .	5-22
Fig. 5-15 – 3-Leg Side, 1 Approach Lane + LT, Signal Control, Approach Route Goes Through	5-23
Fig. 5-16 – 3-Leg Side, 2 Approach Lanes + 2LT, Signal Control, Approach Route Goes Through	5-24
Fig. 5-17 – 4-Leg, 1 Approach Lane, Stop Control, Approach Route Goes Through . . . . .	5-26
Fig. 5-18 – 4-Leg, 1 Approach Lane with Free Right Turn, No Control, Approach Lane Goes Through	5-27
Fig. 5-19 – 4-Leg, 1 Approach Lane, Stop Control, Approach Route Goes Through & Left . . . . .	5-28
Fig. 5-20 – 4-Leg, 1 Approach Lane, Signal Control, Approach Route Goes Through. . . . .	5-29
Fig. 5-21 – 4-Leg, 1 Approach Lane, Signal Control, Approach Route Goes Through & Right . . . . .	5-30
Fig. 5-22 – 4-Leg, 1 Approach Lane, Signal Control, Approach Route Goes Through & Left . . . . .	5-31
Fig. 5-23 – 4 Leg, 2 Approach Lanes, No Control, Approach Route Goes Through. . . . .	5-32
Fig. 5-24 – 4-Leg, 1 Approach Lane + LT, Signal Control, Approach Route Goes Through . . . . .	5-33
Fig. 5-25 – 4-Leg with Local Street, 1 Approach Lane, Stop Control, Approach Route Ends . . . . .	5-34
Fig. 5-26 – 4-Leg with Local Street, 1 Approach Lane, Stop Control, Approach Route Goes Left	5-35
Fig. 5-27 – 4-Leg with Local Street, 1 Approach Lane, Stop Control, Approach Route Goes Left & Right	5-36
Fig. 5-28 – 4-Leg with Local Street, 1 Approach Lane, Signal Control, Approach Route Goes Right	5-37
Fig. 5-29 – 4-Leg, 1 Approach Lane, Signal Control, Approach Routes Go Left & Right . . . . .	5-38

---

Fig. 6-1 – Departure Sign Placement Guide Signs beyond the No Sign Zone . . . . .	6-7
Fig. 6-2 – Departure Sign Placement, Multiple Signs beyond the No Sign Zone . . . . .	6-8
Fig. 6-3 – Departure Sign Placement, Signs Located within the No Sign Zone . . . . .	6-9
Fig. 7-1 – Difference in Operations between a Wide and Narrow Median . . . . .	7-3
Fig. 7-2 – Measuring Median Width . . . . .	7-4
Fig. 7-3 – Signing for Wide Median Divided Highway Intersection with Left Turn Bay and One External Road . . . . .	7-5
Fig. 7-4 – Signing for Wide Median Divided Highway Intersection with Left Turn Bay and Two External Roads . . . . .	7-6
Fig. 7-5 – Signing for Wide Median Divided Highway Intersection without Turn Bay and One External Road . . . . .	7-7
Fig. 7-6 – Signing for Narrow Median Divided Highway Intersection with Left Turn Bay and One External Road . . . . .	7-8
Fig. 7-7 – Signing for Narrow Median Divided Highway Intersection with Left Turn Bay and Two External Roads . . . . .	7-9
Fig. 7-8 – Signing for Narrow Median Divided Highway Intersection without Turn Bay and One External Road . . . . .	7-10
Fig. 7-9 – Signing for Wide Median Divided Highway Intersection with Local Road . . . . .	7-11
Fig. 7-10 – Signing for Wide Median Crossover with Left Turn Bay . . . . .	7-13
Fig. 7-11 – Signing for Wide Median Crossover without Turn Bay . . . . .	7-14
Fig. 7-12 – Signing for Narrow Median Crossover with Left Turn Bay . . . . .	7-15
Fig. 7-13 – Signing for Narrow Median Crossover without Turn Bay . . . . .	7-16
Fig. 7-14 – Signing for Offset Side T Intersections with Overlapping Routes . . . . .	7-18
Fig. 7-15 – Road Ends Signing . . . . .	7-20
Fig. 7-16 – Interchange Approach, 1 Lane Approach, Yield Ramp Control, Approach Route Goes Through . . . . .	7-22
Fig. 7-17 – Interchange Departure, 1 Lane Approach, Yield Ramp Control, Approach Route Goes Through . . . . .	7-23
Fig. 7-18 – Interchange Approach, 1 Lane Approach, Stop Ramp Control, Approach Route Goes Through . . . . .	7-24
Fig. 7-19 – One-Way Frontage Road Intersection Area Detail . . . . .	7-25
Fig. 7-20 – One-Way Frontage Road with Exit Ramp, 2 Lane Approach, Stop Control . . . . .	7-26
Fig. 7-21 – Two-Way Frontage Road with Exit Ramp, 1 Lane Approach, Stop Control . . . . .	7-27
Fig. 7-22 – Lane Drop at Intersection . . . . .	7-29
Fig. 8-1 – Object Markers . . . . .	8-5
Fig. 8-2 – Object Marker at Energy Absorbing Treatment (EAT) . . . . .	8-7
Fig. 8-3 – Object Marker at Turndown (Texas Twist) . . . . .	8-7
Fig. 8-4 – Delineators . . . . .	8-8
Fig. 8-5 – Typical Delineator Installation . . . . .	8-10
Fig. 8-6 – Delineator Installation on Guardrail Post . . . . .	8-11
Fig. 8-7 – Delineation for Median Opening with Left Turn Lane on Approach . . . . .	8-14
Fig. 8-8 – Delineation for Median Opening with No Left Turn Lane on Approach . . . . .	8-14
Fig. 8-9 – Barrier Reflectors . . . . .	8-15
Fig. 8-10 – Typical Barrier Reflector Installation . . . . .	8-16
Fig. 8-11 – Barrier Reflector Spacing . . . . .	8-17

---

Fig. 8-12 – Two-Way, Two-Lane Road or Bridge with Guardrail and No Change in Approach Width 8-19	
Fig. 8-13 – Two-Way, Two-Lane Road or Bridge with Guardrail and Reduced Width Approach	8-20
Fig. 8-14 – Two-Way, Two-Lane Bridge No Approach Rail (Bridgerail Only)	8-21
Fig. 8-15 – Multi-lane Undivided, Two-Way Road or Bridge with Guardrail	8-22
Fig. 8-16 – One-Way Road or Bridge (or Divided Highway) with Guardrail	8-23
Fig. 8-17 – Two-Way Road over Culvert	8-24
Fig. 8-18 – Freeway Delineation	8-25
Fig. 8-19 – One-Way Ramp Detail	8-26
Fig. 9-1 – Approximate Distance between Mailbox Installations	9-6
Fig. 9-2 – Mailbox Longitudinal Placement within a Mailbox Turnout	9-6
Fig. 9-3 – Mailbox Placement at Rural Locations: Through Highway Speed $\geq$ 55 mph	9-7
Fig. 9-4 – Mailbox Placement at Rural Locations: Through Highway Speed $<$ 55 mph	9-7
Fig. 9-5 – Lateral Placement for Delivery to the Front Side	9-8
Fig. 9-6 – Lateral Placement for Delivery to the Back Side	9-8
Fig. 9-7 – Height of Mailbox	9-9
Fig. 9-8 – Coat Hanger Multiple Support	9-11
Fig. 9-9 – Constant Radius Multiple Support	9-11
Fig. 9-10 – Orientation of Supports/Anchors for Single/Double Mailbox Installations	9-12
Fig. 9-11 – Mailbox Bracket (shown upside down)	9-13
Fig. 9-12 – Attaching the Bracket to a Single Support	9-14
Fig. 9-13 – Use of the Adapter Plate for a Double Mailbox Installation	9-15
Fig. 9-14 – Attaching the Bracket to the Multiple Support	9-15
Fig. 9-15 – Bolting the Bracket to a Multiple Support Tube	9-16
Fig. 9-16 – Installation of Single Mailbox on Wing Channel Support	9-17
Fig. 9-17 – Installation of a Double Mailbox on a Wing Channel Support	9-18
Fig. 9-18 – Installation of a Multiple Mailbox Support	9-19
Fig. 9-19 – Type 2 Object Marker Installations	9-20
Fig. 9-20 – Type 2 Object Marker Installation (Sheeting Wrap on Multiple Post)	9-21
Fig. 9-21 – Placement of Emergency Location Number	9-22
Fig. 9-22 – Newspaper Receptacle Placement	9-23
Fig. 9-23 – Standard Letter for Non-Compliant Mailbox	9-24

---

## List of Tables

Table 2-1 – Minimum Advance Placement Distances for Warning Signs .....	2-4
Table 2-2 – Warning Sign Placement Conditions .....	2-5
Table 2-3 – Watch For Ice on Bridge Sign Display Schedule .....	2-7
Table 3-1 – Types and Purposes of Guide Sign Components .....	3-3
Table 3-2 – Components of a Guide Sign Unit .....	3-16
Table 3-3 – Arrangement of Units by Direction within an Assembly .....	3-17
Table 5-1 – Approach Placement Distances .....	5-7
Table 5-2 – Index to Approach Placement Illustrations .....	5-9
Table 8-1 – Uses of Delineators .....	8-9
Table 8-2 – Suggested Spacing for Highway Delineators on Horizontal Curves Based on Degree of Curve 8-12	
Table 8-3 – Suggested Spacing for Highway Delineators on Horizontal Curves Based on Advisory Speed 8-13	
Table 9-1 – Mailbox Sizes .....	9-3
Table 9-2 – Support and Foundation Combinations .....	9-12

# Chapter 1

## Introduction

### Contents:

[Section 1 — Overview](#)

[Section 2 — Background Information](#)

## Section 1

### Overview

#### Introduction

Prior to the publication of the first edition of the *Sign Crew Field Book* in 1997, field sign crews had to rely upon the *Texas Manual on Uniform Traffic Control Devices* (Texas MUTCD), the TxDOT Traffic Control Standard Sheets, or instructions from supervisors to determine the most effective placement of traffic signs on conventional highways. However, these documents primarily address sign design and selection, with less detailed information on sign placement. The *Sign Crew Field Book* is intended to provide field sign personnel with information beyond that contained in the Texas MUTCD or the TxDOT Traffic Engineering Standard Sheets to improve statewide uniformity in the placement of traffic signs. This field book is specifically intended for use by field sign crews. Therefore, it emphasizes the use of figures and contains only limited amounts of text.

Chapter 1 provides background information about the field book, including its relation to other signing documents and the general content in the remainder of the field book.

## Section 2

### Background Information

#### Purpose of Field Book

The main purposes of this field book are to:

- ◆ provide field personnel with information that will help them to install traffic signs on conventional highways in a more effective and consistent manner,
- ◆ increase uniformity in the placement of traffic signs on conventional highways for the benefit of the traveling public, and
- ◆ address guide signing situations that are not covered in the Texas MUTCD or other TxDOT documents.

This field book is intended for application only on rural, conventional (non-access controlled) highways.

Although this field book illustrates the use and/or placement of traffic signs, it does not establish any warrants or standards for the selection and placement of traffic signs.

#### Status of Field Book

The information in this field book is presented as guidance information for use by field personnel. This field book does not establish any standards, specifications, or regulations. This field book carries no legal authority. This field book does not replace or supersede the *Texas Manual on Uniform Traffic Control Devices*.

#### Organization of the Sign Crew Field Book

The *Sign Crew Field Book* consists of the following chapters:

- ◆ Chapter 1 contains information regarding the use of the field book and its relationship to other TxDOT documents.
- ◆ Chapter 2 describes information about warning signs.
- ◆ Chapter 3 describes the different types of guide signs.
- ◆ Chapter 4 contains figures showing height and lateral placement for traffic signs.
- ◆ Chapter 5 contains illustrations for sign placement on approaches to intersections.
- ◆ Chapter 6 contains illustrations for sign placement on the departure from an intersection.
- ◆ Chapter 7 addresses special signing situations.

- ◆ Chapter 8 provides information on the delineation of bridges and other objects.
- ◆ Chapter 9 provides information related to the installation of mailboxes.

### Relationship to Other TxDOT Documents

This field book presents guidance information that may support or supplement information contained in other TxDOT documents. The guidance contained in this field book does not supersede standards, recommended practices, or requirements established by other TxDOT documents.

- ◆ **Texas MUTCD** - The *Texas Manual on Uniform Traffic Control Devices* establishes practices for the selection, design, placement, operation, and maintenance of traffic control devices. Many of the figures in this field book contain cross-references to the Texas MUTCD to assist the user in determining the recommended practices for the use of a traffic control device. When a figure contains a cross-reference to the Texas MUTCD, the user should refer to the indicated section of the Texas MUTCD to determine the appropriate use of the sign. The 2006 Texas MUTCD was used in the preparation of this edition of the field book.
- ◆ **Traffic Engineering Standard Sheets** - The standard sheets developed by the Traffic Operations Division contain additional guidance for the design, placement, and mounting of traffic signs.
- ◆ **Standard Highway Sign Designs for Texas** - The signs shown in the figures are provided for illustrative purposes only. Every effort has been extended to ensure that the appearances of the signs in these figures are accurate representations of the actual sign design. However, the Standard Highway Sign Designs for Texas should be used to determine the design and/or layout of signs.

In the case of differences in the guidance provided by various signing documents, the Texas MUTCD establishes the minimum criteria that shall, should, or may be followed as appropriate. The *Sign Crew Field Book* criteria should be followed to the extent possible. Compliance for a sign installation is based on the minimum criteria in the Texas MUTCD.

### Use of Signs in Figures

A large number of figures in the *Sign Crew Field Book* show signs or other devices at or near an intersection. These figures are intended to show the location of the sign, if the sign is used. The inclusion of a sign in a figure is not intended to indicate that the sign shall or should be used. The decision to install or not install a sign should be made on the basis of engineering judgment or an engineering study as described in the Texas MUTCD. Where appropriate, the field book indicates the section of the Texas MUTCD that relates to the use of a specific sign.



## Relationship of Intersection Illustrations to Actual Intersections

The *Sign Crew Field Book* contains numerous illustrations of intersections that use route signs with various highway numbers. The intersections illustrated in this field book are NOT intended to represent actual intersections in the field. Any similarities between the highway routes illustrated in the field book and actual highways and/or intersections in the field are coincidental.

## History of the Sign Crew Field Book

The original edition of the *Sign Crew Field Book* was the product of a TxDOT research project on rural guide signing (Project 0-1373, Evaluation of Conventional Guide Signing). The initial field book was developed by researchers with the Texas Transportation Institute working closely with TxDOT staff who provided significant input on the content. The researchers prepared a second edition as part of the same research project. This third edition was prepared as part of Project 0-4701, Traffic Control Device Evaluation and Development Program.

## Helpful Information for First Time Users

The following information in the field book may be of particular value to first time users:

- ◆ Chapter 3, Section 3 describes how to arrange route signs in an assembly.
- ◆ Figure 3-23 provides a flow chart to help sign crews determine the proper layout for an assembly.
- ◆ The distances shown in the figures in Chapters 5 and 6 are from the near edge of the intersecting road.
- ◆ A particular type of sign should always be the same distance from the intersection, even if other signs that would normally be closer to the intersection are not used.
- ◆ Table 5-2 provides an index for the approach placement illustrations.
- ◆ Signs on the approach should be spaced so that there is at least 325 ft between sign installations.
- ◆ Signs on the departure should be spaced so that there is at least 325 ft between sign installations.
- ◆ The “no sign zone” is defined as the first 200-300 ft from the intersection. Signs should not be placed in this zone unless the sign cannot be relocated beyond the no sign zone.
- ◆ The figures in the field book show placement of a sign, if the sign is used. The fact that a sign is shown in a figure does not indicate that the sign is required to be used. In general, the Texas MUTCD section number is provided in the figure for signs that could be considered optional.

# Chapter 2

## Warning Signs

### Contents:

[Section 1 — Overview](#)

[Section 2 — Warning Sign Advance Placement](#)

[Section 3 — Watch for Ice on Bridge Sign](#)

## **Section 1**

### **Overview**

#### **Introduction**

This chapter provides field installation details about warning signs. Section 2 provides guidance on the minimum distance at which a sign should be placed in advance of a potential hazard. This guidance is an expanded version of the information in the Texas MUTCD. Section 3 addresses issues related to the Watch for Ice on Bridge warning sign.

## Section 2

### Warning Sign Advance Placement

#### Introduction

Warning signs are placed in advance of a potential hazard. The Texas MUTCD presents basic information in Table 2C-4 of the manual. The information in this section expands upon the information in the Texas MUTCD.

#### Advance Placement Condition Descriptions

The placement of a warning sign is based on the potential hazard the sign warns of and the amount of advance warning needed by a road user. There are five placement conditions:

- ◆ **Condition A** represents a situation that involves a complex driving decision, often in heavy traffic conditions. Lane changes in heavy traffic, exiting maneuvers, and merging traffic are common examples. This condition typically applies to freeways and high volume urban arterial situations that require additional response time.
- ◆ **Condition B** represents a condition where a vehicle may have to stop as a result of the potential hazard identified by the warning sign.
- ◆ **Condition C** represents a condition where a vehicle may need to slow down in response to the potential hazard.
- ◆ **Condition D** represents a condition where a vehicle may not need to slow down in responding to the potential hazard indicated by the warning sign.
- ◆ **Condition E** represents a condition where the warning sign is placed at or in close proximity to the potential hazard indicated by the warning sign.

#### Relation Between Minimum Distances and Sign Crew Field Book Distance

The minimum advance placement distances for warning signs shown in the next subheading are intended primarily for installation of isolated warning signs. When a warning sign is installed as part of a series of signs, it may be appropriate to place a warning sign further from the potential hazard than the values indicated in the table. In particular, warning signs on the approach or departure from an intersection are placed using the distances shown in the figures in Chapters 5 and 6 to maintain the system perspective with all the signs on the approach or departure.

**Advance Placement Distance for Warning Signs**

Warning signs are placed in advance of a potential hazard based on the roadway speed limit, the type of response needed (the condition), and the speed associated with the warning sign response. Table 2-1 presents the minimum advance placement distances for warning signs. This table is an expansion of the information in Table 2C-4 from the Texas MUTCD. The underlined information was added to Table 2-1. Table 2-2 provides a description of each condition and information about which warning signs are associated with each condition.

**Table 2-1: Minimum Advance Placement Distances for Warning Signs**

Posted Speed (mph)	Condition <sup>A</sup>																		
	A	B: Stop	C: decelerate to indicated advisory speed (mph)															D	E
			5	10	15	20	25	30	35	40	45	50	55	60	65	70	75		
20	225	x <sup>B</sup>	x <sup>B</sup>	x <sup>B</sup>	x <sup>B</sup>	x <sup>C</sup>	—	—	—	—	—	—	—	—	—	—	—	x <sup>B</sup>	<u>0</u>
25	325	x <sup>B</sup>	x <sup>B</sup>	x <sup>B</sup>	x <sup>B</sup>	x <sup>B</sup>	x <sup>C</sup>	—	—	—	—	—	—	—	—	—	—	x <sup>B</sup>	<u>0</u>
30	450	x <sup>B</sup>	x <sup>B</sup>	x <sup>B</sup>	x <sup>B</sup>	x <sup>B</sup>	x <sup>B</sup>	x <sup>C</sup>	—	—	—	—	—	—	—	—	—	x <sup>B</sup>	<u>0</u>
35	550	<u>100</u>	x <sup>B</sup>	x <sup>B</sup>	x <sup>B</sup>	x <sup>B</sup>	x <sup>B</sup>	x <sup>B</sup>	x <sup>C</sup>	—	—	—	—	—	—	—	—	x <sup>B</sup>	<u>0</u>
40	650	125	<u>100</u>	<u>100</u>	x <sup>B</sup>	x <sup>B</sup>	x <sup>B</sup>	x <sup>B</sup>	x <sup>B</sup>	x <sup>C</sup>	—	—	—	—	—	—	—	x <sup>B</sup>	<u>0</u>
45	750	175	<u>125</u>	125	<u>100</u>	<u>100</u>	x <sup>B</sup>	x <sup>B</sup>	x <sup>B</sup>	x <sup>B</sup>	x <sup>C</sup>	—	—	—	—	—	—	x <sup>B</sup>	<u>0</u>
50	850	250	<u>200</u>	200	<u>175</u>	150	<u>125</u>	100	100	x <sup>B</sup>	x <sup>B</sup>	x <sup>C</sup>	—	—	—	—	—	x <sup>B</sup>	<u>0</u>
55	950	325	<u>275</u>	275	<u>250</u>	225	<u>200</u>	175	150	100	<u>100</u>	x <sup>B</sup>	x <sup>C</sup>	—	—	—	—	x <sup>B</sup>	<u>0</u>
60	1100	400	<u>350</u>	350	<u>325</u>	300	<u>300</u>	250	225	175	<u>150</u>	<u>100</u>	x <sup>B</sup>	x <sup>C</sup>	—	—	—	x <sup>B</sup>	<u>0</u>
65	1200	475	<u>450</u>	425	<u>425</u>	400	<u>375</u>	350	300	275	<u>225</u>	175	<u>125</u>	<u>100</u>	x <sup>C</sup>	—	—	<u>100</u>	<u>0</u>
70	1250	550	<u>525</u>	525	<u>500</u>	500	<u>475</u>	425	400	350	<u>325</u>	250	<u>200</u>	150	<u>100</u>	x <sup>C</sup>	—	<u>100</u>	<u>0</u>
75	1350	650	<u>625</u>	625	<u>600</u>	600	<u>575</u>	525	500	450	<u>425</u>	350	<u>300</u>	250	<u>175</u>	100	x <sup>C</sup>	<u>100</u>	<u>0</u>
80	1475	725	<u>725</u>	725	<u>700</u>	700	<u>675</u>	625	600	550	<u>525</u>	475	<u>400</u>	350	<u>275</u>	200	125	<u>125</u>	<u>0</u>

Notes:  
 These are minimum placement distances. Signs may be placed further away if appropriate.  
<sup>A</sup>See Table 2-2 for a list of the signs associated with each condition. The preceding page describes each of the conditions.  
<sup>B</sup>Calculated placement distance is less than 50 ft. Accordingly, no suggested placement distance provided.  
<sup>C</sup>See distance for Condition D.  
 Underlined distances are not provided in MUTCD Table 2C-4.  
 — Advisory speed is greater than the posted speed, placement distance not appropriate.

**Conditions Associated with Specific Warning Signs**

Table 2-2 lists the signs that are associated with the five conditions used in Table 2-1

**Table 2-2: Warning Sign Placement Conditions**

Placement Condition	Condition Description	Applicable Warning Signs	
A	Complex Maneuvers	W4-1, Merge W4-1a, Thru Traffic Merge Right	W9-1, Right (Left) Lane Ends W9-2, Lane Ends Merge Left (Right)
B	Stop	W2-1, Cross Road W2-2, Side Road (perpendicular) W2-3, Side Road (oblique) W2-4, T symbol W2-5, Y symbol W2-6, Circular Intersection W3-1, Stop Ahead W3-2, Yield Ahead W3-3, Signal Ahead W5-3, One Lane Bridge W8-6, Truck Crossing W8-13t, Water Crossing W8-14, Water Over Road W8-15, Watch for Water on Road W10-1, Advance Railroad Crossing W10-2, Parallel Railroad Crossing (cross road) W10-3, Parallel Railroad Crossing (side road) W10-4, Parallel Railroad Crossing (T road) W10-5, Low Ground Clearance W10-11, Railroad T Crossing W10-12, Railroad Skewed Crossing W11-1, Bicycle Crossing W11-2, Pedestrian Crossing W11-3, Deer Crossing W11-4, Cattle Crossing W11-5a, Farm Machinery Crossing	W11-6, Snowmobile Crossing W11-7, Equestrian Crossing W11-8, Emergency Vehicle Crossing W11-9, Handicapped Crossing W11-10, Truck Crossing W11-11, Golf Cart Crossing W11-11T, Watch for Emergency Vehicles W11-14, Horse and Buggy Crossing W12-2, Low Clearance W14-1T, Road Ends W14-1, Dead End W15-1, Playground W19-1, Draw Bridge Ahead W19-2, Watch for Ice on Bridge W19-3, Ramp Metered When Flashing W19-4, Ramp Signal Ahead W19-6, Loose Livestock W19-10, Falling Rock W19-11, Rock Slides W19-12, Earth Slides W19-14, Watch for Smoke on Road W19-15, Watch for Mud on Road W20-1, Weigh Station 1 Mile W20-1a, Check Station 1 Mile W20-2, Weigh Station ½ Mile W20-2a, Check Station ½ Mile W20-3D, Inspection Station Ahead W20-7b, Be Prepared to Stop
C	Decelerate to Indicated Advisory Speed	All warning signs with an advisory speed plaque W3-5, Speed Reduction (use speed shown in sign as advisory speed) W7-6, Hill Blocks View W13-2, Exit Speed W13-3, Ramp Speed	W13-5, Curve Speed W17-1, Speed Hump

**Table 2-2: Warning Sign Placement Conditions**

<b>Placement Condition</b>	<b>Condition Description</b>	<b>Applicable Warning Signs</b>	
D	No Speed Reduction	W1-1, Turn W1-2, Curve W1-3, Reverse Turn W1-4, Reverse Curve W1-5, Winding Road W1-11, Hairpin Curve W1-13, Truck Rollover W1-15, 270° Loop W4-3, Added Lane W5-1, Road Narrows W5-2, Narrow Bridge W6-1, Divided Highway W6-2, Divided Highway Ends W6-3, Two Way Traffic	W7-1, Hill W8-1, Bump W8-2, Dip W8-3, Pavement Ends W8-4, Soft Shoulder W8-5, Slow Down on Wet Road W8-7, Loose Gravel W8-8, Rough Road W8-9, Low Shoulder W8-12, No Center Stripe W10-6, Uneven Tracks W14-1, Dead End W14-2, No Outlet W14-3, No Passing Zone
E	Sign at Hazard	W1-6, One Direction Large Arrow W1-7, Two Direction Large Arrow	W1-8, Chevron Alignment W12-1, Double Arrow

## Section 3

### Watch for Ice on Bridge Sign

#### Introduction

The Watch for Ice on Bridge (W19-2) sign is used to warn of the potential for ice on a bridge.

#### Placement for Watch for Ice on Bridge Sign

The Watch for Ice on Bridge sign should be placed using the Condition B (stop) distances in Table 2-1. For a series of closely spaced bridges, the sign need only be placed on the first bridge in each direction and not between each point of access and subsequent bridges.

#### Sign Display Schedule

Since ice on a bridge is a temporary condition, the sign should be removed or folded up from view of the motorists when the potential for ice accumulations will not be expected for extended periods. Table 2-3 indicates the dates that the Watch for Ice on Bridge sign should be displayed. The sign should be unfolded prior to the “Display Sign From” date and folded after the “Display Sign To” date.

**Table 2-3: Watch For Ice on Bridge Sign Display Schedule**

District	County	Display Sign From	Display Sign To
Abilene	Fisher, Kent, Shackelford	November 9	March 23
	Callahan, Haskell, Howard, Jones, Mitchell, Nolan, Scurry, Stonewall, Taylor	November 9	April 7
Amarillo	Armstrong, Hemphill, Lipscomb, Randall	October 24	April 7
	Carson, Dallam, Deaf Smith, Gray, Hansford, Hartley, Hutchinson, Moore, Ochiltree, Oldham, Potter, Roberts, Sherman	October 24	April 22
Atlanta	Bowie, Camp, Cass, Harrison, Marion, Morris, Panola, Titus, Upshur	November 9	March 23
Austin	Blanco	November 9	March 23
	Burnet, Gillespie, Llano, Mason	November 9	April 7
	Caldwell, Hays, Lee	November 24	March 8
	Travis, Williamson	November 24	March 23
	Bastrop	November 25	March 8



**Table 2-3: Watch For Ice on Bridge Sign Display Schedule**

<b>District</b>	<b>County</b>	<b>Display Sign From</b>	<b>Display Sign To</b>
Beaumont	Hardin, Jefferson	November 9	March 8
	Jasper, Newton, Orange	November 9	March 23
	Chambers, Liberty	November 24	March 8
Brownwood	Coleman, Eastland	November 9	March 23
	Lampasas, McCulloch, Mills, San Saba, Stephens	November 9	April 7
	Brown, Comanche	November 24	March 23
Bryan	Burleson, Freestone, Grimes, Leon, Milam, Robertson, Walker	November 24	March 8
	Brazos, Madison	December 9	March 8
	Washington	December 9	February 21
Childress	Briscoe, Childress, Cottle, Dickens, Foard, Hall, Hardeman, King, Knox, Motley	November 9	April 7
	Collingsworth, Donle	October 24	April 7
Corpus Christi	Aransas, Kleberg	December 9	February 6
	Bee, Goliad, Jim Wells, Live Oak, Nueces, Refugio, San Patricio	December 9	February 21
	Karnes	December 9	March 8
Dallas	Collin, Dallas, Denton, Rockwall	November 9	March 23
	Navarro	November 24	March 8
	Ellis, Kaufman	November 24	March 23
El Paso	Hudspeth	October 24	March 23
	Brewster, El Paso, Presidio	November 9	March 23
	Culberson, Jeff Davis	November 9	April 7
Fort Worth	Erath, Hood, Johnson, Parker, Somervell, Tarrant, Wise	November 9	March 23
	Jack, Palo Pinto	November 9	April 7
Houston	Fort Bend, Waller	November 24	February 21
	Brazoria, Galveston, Harris, Montgomery	November 24	March 8
Laredo	Kinney, Zavala	November 24	March 8
	Val Verde	November 24	March 23
	Dimmit, Duval, La Salle, Maverick, Webb	December 9	February 21

**Table 2-3: Watch For Ice on Bridge Sign Display Schedule**

<b>District</b>	<b>County</b>	<b>Display Sign From</b>	<b>Display Sign To</b>
Lubbock	Swisher, Terry	October 24	April 7
	Bailey, Castro, Cochran, Hockley, Lamb, Parmer, Yoakum	October 24	April 22
	Crosby, Dawson, Floyd, Gaines, Garza, Hale, Lubbock, Lynn	November 9	April 7
Lufkin	Nacogdoches, Polk	November 9	March 8
	Angelina, Sabine, San Augustine, Tyler	November 9	March 23
	Houston, San Jacinto, Shelby, Trinity	November 24	March 8
Odessa	Terrell	November 9	March 23
	Andrews, Crane, Ector, Loving, Martin, Midland, Pecos, Reeves, Upton, Ward, Winkler	November 9	April 7
Paris	Delta, Fannin, Franklin, Grayson, Hopkins, Hunt, Lamar, Red River	November 9	March 23
	Rains	November 24	March 23
Pharr	Brooks, Cameron, Hidalgo, Kenedy, Willacy	December 9	February 6
	Jim Hogg, Starr, Zapata	December 9	February 21
San Angelo	Crockett, Irion, Reagan, Runnels, Schleicher, Sutton, Tom Green	November 9	March 23
	Coke, Concho, Edwards, Glasscock, Kimble, Menard, Real, Sterling	November 9	April 7
San Antonio	Kendall	November 9	March 23
	Kerr	November 9	April 7
	Wilson	November 24	February 21
	Bexar, Guadalupe	November 24	March 8
	Bandera, Comal, Medina, Uvalde	November 24	March 23
	Atascosa, Frio, McMullen	December 9	February 21
Tyler	Gregg, Rusk	November 9	March 8
	Anderson, Cherokee, Henderson, Smith	November 24	March 8
	Van Zandt, Wood	November 24	March 23
Waco	Falls, Limestone, McLennan	November 24	March 8
	Bell, Bosque, Coryell, Hamilton, Hill	November 24	March 23

**Table 2-3: Watch For Ice on Bridge Sign Display Schedule**

<b>District</b>	<b>County</b>	<b>Display Sign From</b>	<b>Display Sign To</b>
Wichita Falls	Cooke, Montague, Wichita	November 9	March 23
	Archer, Baylor, Clay, Throckmorton, Wilbarger, Young	November 9	April 7
Yoakum	Gonzales	November 24	February 21
	DeWitt, Wharton	November 24	March 8
	Calhoun	December 9	February 6
	Austin, Fayette, Matagorda	December 9	February 21
	Colorado, Jackson, Lavaca, Victoria	December 9	March 8

# Chapter 3

## Types and Uses of Guide Signs

### Contents:

[Section 1 — Overview](#)

[Section 2 — Guide Sign Components](#)

[Section 3 — Arrangement of Components](#)

[Section 4 — Guide Sign Assemblies](#)

[Section 5 — Stand-Alone Signs](#)

## **Section 1**

### **Overview**

#### **Introduction**

Guide signing is variable from one location to another because the signing must relate to the specific circumstances of a particular situation. As a result, there are many different types of guide signs for conventional highways and many different ways that these signs can be displayed.

Chapter 3 describes and illustrates the different types of conventional guide signs and how they should be displayed. The descriptions include the general purpose of each type, guidance on how it should be applied, and illustrations of how it appears. Additional descriptions and illustrations indicate how guide signs should be displayed within a guide sign assembly.

## Section 2

### Guide Sign Components

#### Introduction

Directional information on conventional highways is provided primarily through the use of highway class, highway number, and cardinal directions. Destination information (city names) may also be provided, but this information is of secondary emphasis.

Conventional guide signs consist of assemblies and stand-alone signs. Assemblies are created by combining several different signing components in a single sign installation. Stand-alone signs are a single sign and are described in more detail in Section 5 (page 3-38).

The typical single assembly consists of, from top to bottom, a cardinal direction sign, a route sign, and a directional arrow sign. Single assemblies may be combined at one sign installation so that there could be various combinations of cardinal direction signs, route signs, and arrow signs.

There are also other types of signs that are sometimes used in assemblies.

This section describes the different types of components that can be used in a conventional guide sign assembly. Table 3-1 identifies the guide signs that are used to provide directional information and the general purpose for each of these types of signs. The table also identifies the figures that illustrate the appearance of each type of sign. Specific uses and applications of these signs are described and illustrated in the remaining subsections.

The arrangement of these components within an assembly is described in Section 3, and the different types of assemblies are described in Section 4.

**Table 3-1: Types and Purposes of Guide Sign Components**

Location in Assembly	Type of Guide Sign	General Purpose	Illustrated in
Above Route Sign	Cardinal Direction Signs	Provide a general indication of the direction of travel of the highway over its full length.	Figure 3-6
	Junction Signs	Provide advance notice of the intersection of two or more highways.	Figure 3-4, 3-5
	Auxiliary Signs	Indicate various information about a highway.	Figure 3-14
Route Sign	Route Signs	Indicate the class and number of a particular highway.	Figure 3-2, 3-3
Below Route Sign	Arrow Signs	Indicate turning information at the intersection of two or more highways.	Figure 3-9, 3-10, 3-11, 3-12
	Lane Use Signs	Indicate the proper lane position to travel to the indicated highway.	Figure 3-13

## Route Signs (Texas MUTCD 2D.10 and 2D.11)

**Purpose:** Route signs identify the class and number of the highway of interest.

Route signs can be divided into two different groups, independent mount and guide sign mount, depending upon the manner in which they are mounted. Figure 3-1 illustrates the differences between the two types of route sign mounts, and the differences are described below.

- ◆ Independent Mount - Route signs that are mounted directly to a post. Figure 3-2 shows the appearance of independently mounted route signs.
- ◆ Guide Sign Mount - Route signs that are attached to a larger guide sign. Figure 3-3 shows the appearance of guide sign mounted route signs.

As a general rule, independent route signs should not be mounted within a guide sign, and guide sign route signs should not be mounted on a post.

Route signs of each group can also be divided by the highway classification. They use five basic types of independent route signs: Interstate shield, U.S. Highway shield, State Highway shield, Farm/Ranch to Market Road shield, and toll road shields. For guide sign mount route signs, the State Highway and Farm/Ranch to Market Road shields have similar appearances.

Information about the hierarchy of route signs is provided in Section 3 (page 3-19).

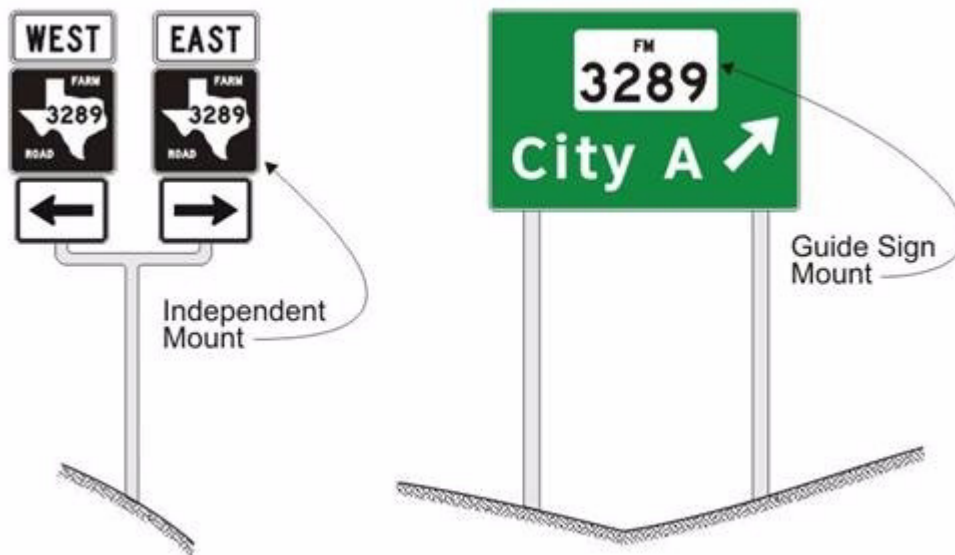

Figure 3-1. Types of Route Sign Mounts

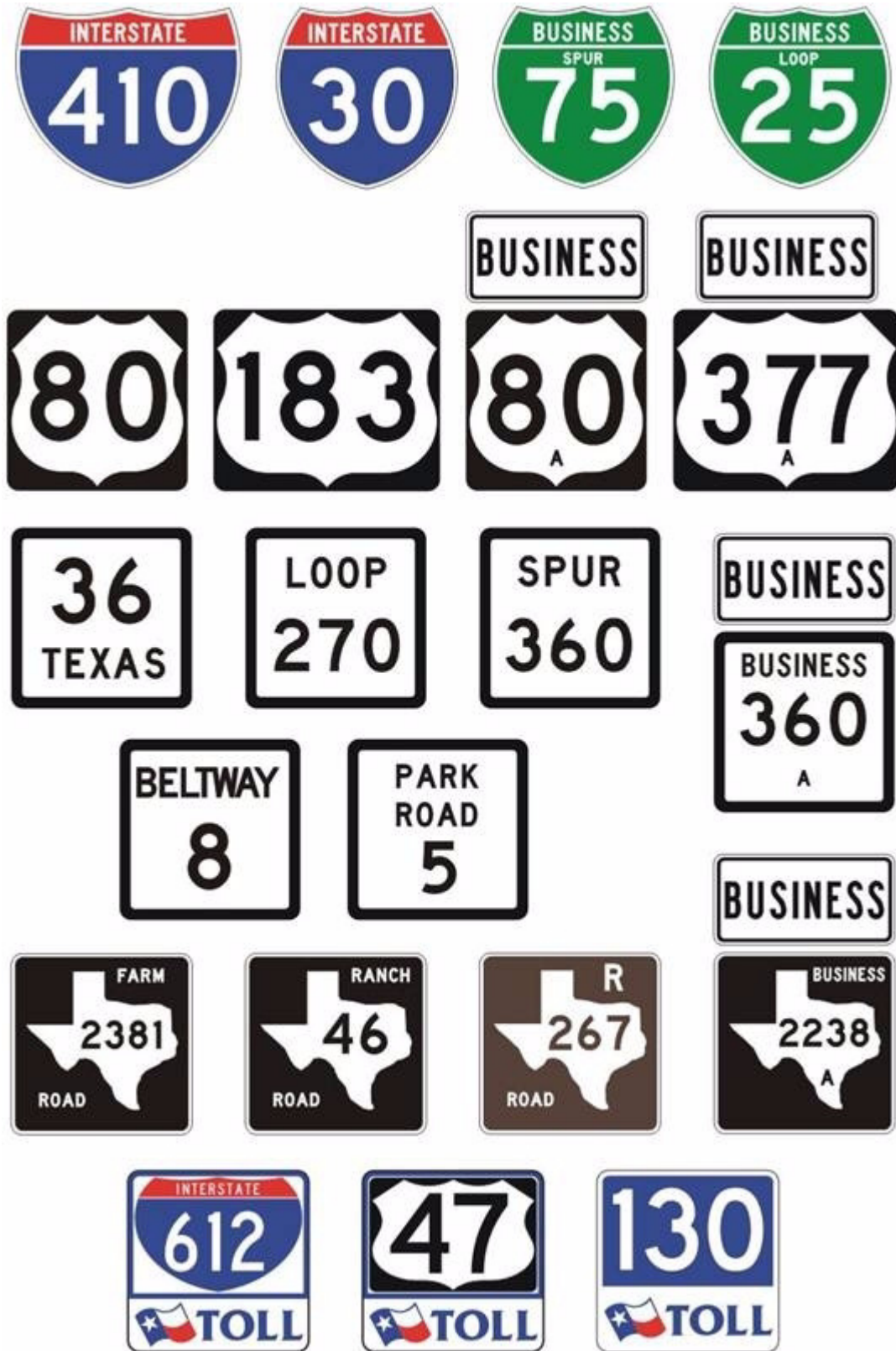

Figure 3-2. Route Signs for Independent Mounting



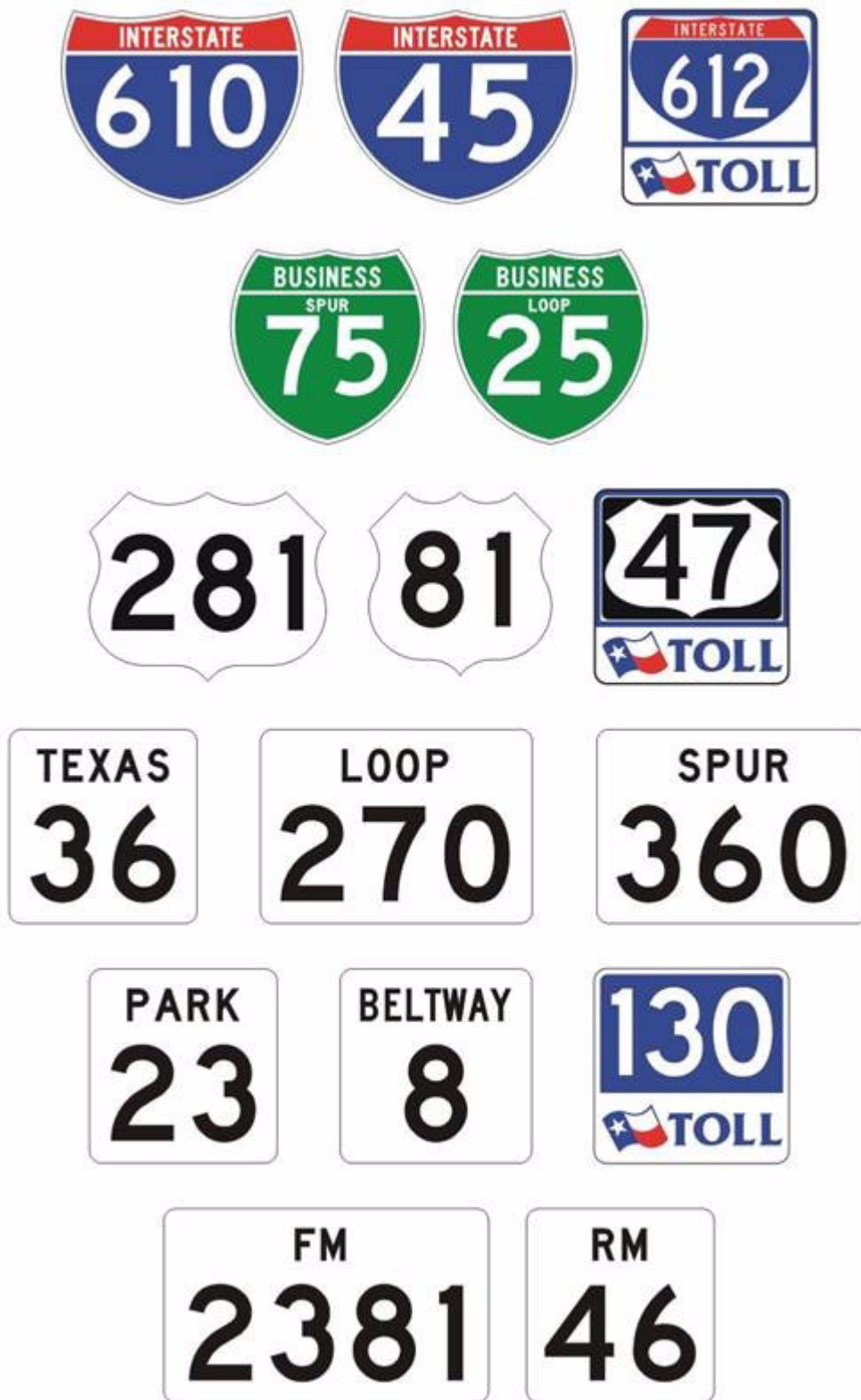

Figure 3-3. Route Signs for Guide Sign Mounting

Special notes for route signs:

- ◆ **Business Auxiliary Sign:** A Business sign (M4-3) should be displayed with the route sign in an independent mount to indicate a business route.
- ◆ **Letter below route number in Business Routes:** All business route signs have a letter below the number in the route shield. This number allows TxDOT to distinguish between business highways in different cities that are off the same major highway. For example, there is a U.S. Highway Business 77 in Robstown (77U), another U.S. Highway Business 77 in Kingsville (77V), and still another in Raymondville (77W). The letter provides an administrative distinction between business highways and is not intended for drivers. Therefore, it is a small letter on the sign. The three business route signs in Figure 3-2 have an “A” below the highway number illustrating this application.

### Junction Sign (Texas MUTCD 2D.13 and 2D.14)

**Purpose:** Junction signs provide advance notice of an intersection with the indicated highway(s).

There are two different methods of indicating a junction:

- ◆ **Junction Auxiliary Sign (Texas MUTCD 2D.13):** Most junctions are indicated with the JCT sign, as shown in Figure 3-4. The Junction sign is mounted at the top of an assembly, either directly above the route sign or above an auxiliary sign (such as BUSINESS or ALT).
- ◆ **Combination Junction Sign (Texas MUTCD 2D.14):** Some junctions may require the use of a combination junction sign, as shown in Figure 3-5. The combination sign contains the word JUNCTION at the top of the sign and the appropriate route signs below. Other information may also be included in the combination sign, such as the cardinal direction, arrows, destination cities, and distance to the junction.

Where shields are used in a Combination Junction sign, they shall mimic the shields used on large ground mounted guide signs (route signs for guide sign mounting).

The Junction Assembly subsection (page 3-30) contains additional information about junction signing and provides additional examples of junction signing.



Figure 3-4. Junction Sign (M2-1)



Figure 3-5. Junction Combination Sign

### Cardinal Direction Auxiliary Signs (Texas MUTCD 2D.15)

**Purpose:** Cardinal Direction auxiliary signs indicate the general direction of a route. A Cardinal Direction auxiliary sign is mounted above the route sign(s) to which it applies. Figure 3-6 illustrates Cardinal Direction auxiliary signs.

Special Notes for Cardinal Direction auxiliary signs:

- ◆ A Cardinal Direction sign should be used with a route sign except in a Reference Marker assembly.
- ◆ It is not appropriate for Cardinal Direction auxiliary signs to use the larger initial letter design shown in the National MUTCD. The preferred design in Texas for Cardinal Direction signs is shown in Figure 3-6.
- ◆ The cardinal direction shown in the auxiliary sign may be different from the actual compass direction of travel on that direction. Each highway has a designated cardinal direction for the highway. For consistency purposes, the cardinal direction for someone traveling on a route should be the same throughout the length on one direction of the highway. Figure 3-7 illustrates how a cardinal direction should remain the same on a highway regardless of the compass direction of travel. Cardinal directions for state routes are established by the Commission at the time of its original designation. Contact TxDOT's Transportation Planning and Programming Division to determine the official cardinal direction for any route.
  - For Interstate and U.S. Highways, even-numbered routes have east-west cardinal directions, and odd-numbered routes have north-south cardinal directions unless the highway is a loop. A loop may use multiple cardinal directions as indicated in Figure 3-8.
  - For all other classes of highways, there is no relationship between the cardinal direction and the route number.
- ◆ For highways not on the Interstate or U.S. Highway system, the cardinal direction is based on the greatest north-south or east-west distance between the start and end point of the highway. If the straight-line east-west distance between the starting and ending point of a highway (statewide, not just in the district) is greater than the straight-line north-south distance, then the cardinal direction should be east-west for the complete length of the highway throughout the state.
- ◆ For a loop highway, for which there is no starting or ending point, the cardinal direction changes to be generally consistent with the compass direction. The changes in cardinal direction should occur at interchanges or intersections. Figure 3-8 illustrates an example of cardinal directions for a loop highway.

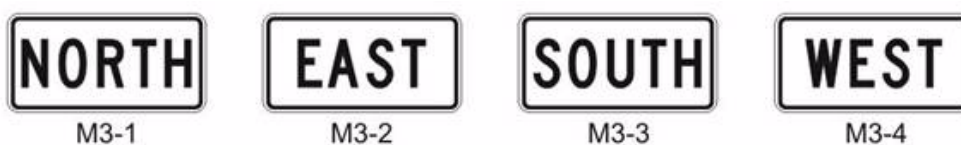

Figure 3-6. Cardinal Direction Signs

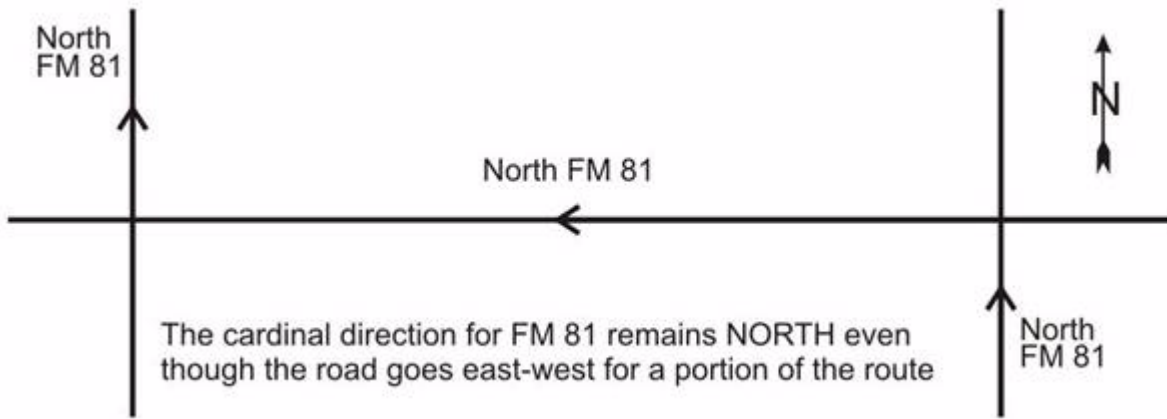

Figure 3-7. Relation between Cardinal Direction and Compass Direction

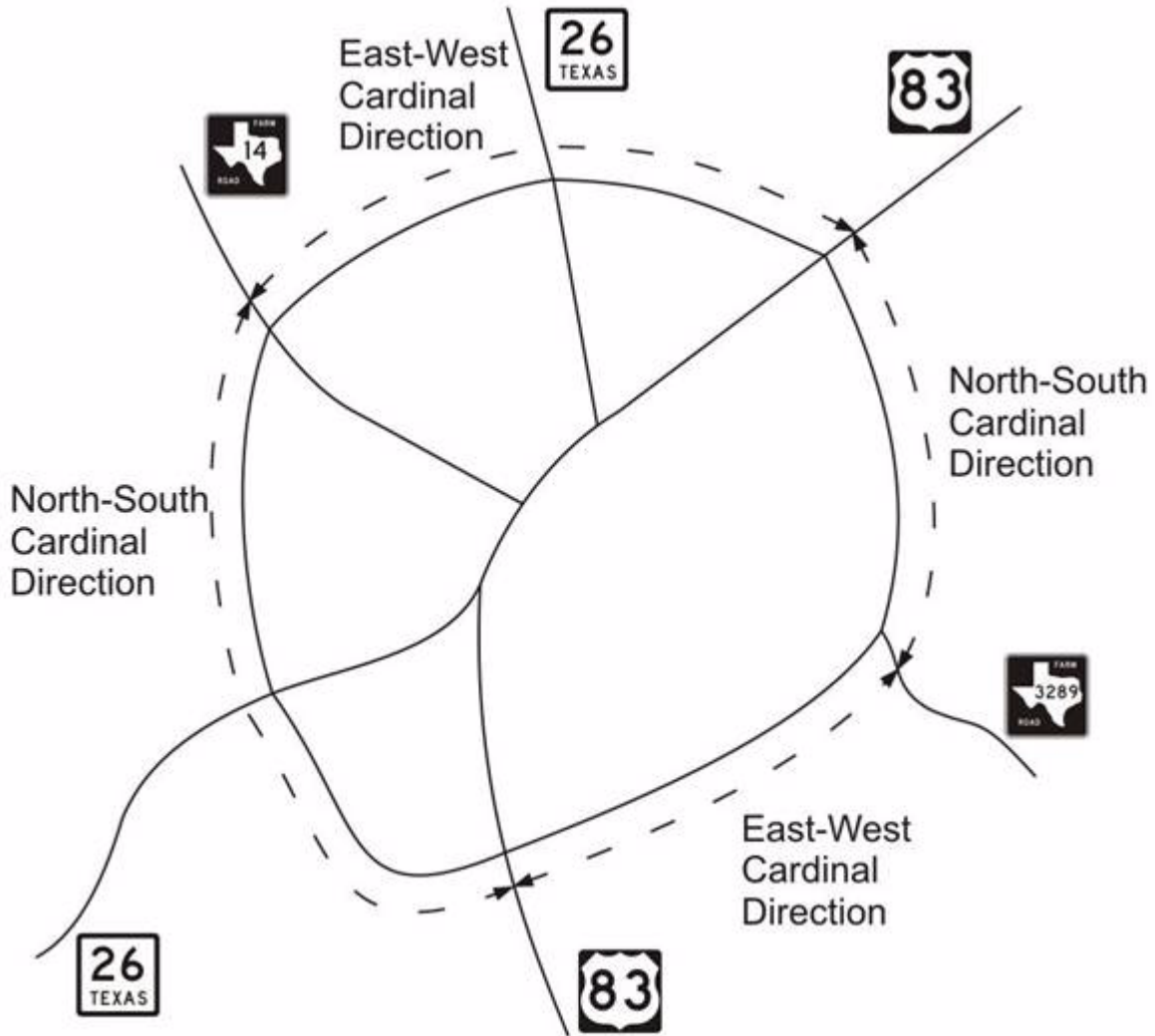

Figure 3-8. Assigning Cardinal Direction for a Non-Interstate Loop Route

**Arrow Signs (Texas MUTCD 2D.25 and 2D.26)**

**Purpose:** Arrow signs indicate the direction of turn necessary to travel on the indicated highway in the indicated cardinal direction. An Arrow sign is mounted below the route sign(s) to which it applies. There are two types of arrow signs: Advance Turn Arrow auxiliary sign and Directional Arrow auxiliary sign.

- ◆ Advance Turn Arrow Auxiliary Signs (Texas MUTCD 2D.25)
  - Advance Turn Arrow signs are used in the Advanced Route Turn Assembly (see page 3-31) to indicate that the route the driver is currently on turns at the highway intersection. This typically occurs where two concurrent (overlapping) highways split, and the driver is required to turn to stay on one of the highways. Advance Turn Arrow auxiliary signs are used only in an Advance Route Turn Assembly (see page 3-31). Examples of Advance Turn Arrow signs are shown in Figure 3-9.
  - The Texas MUTCD requires (a shall condition) the Advance Route Turn Assembly to be used when a turn must be made to remain on the indicated highway. The Advance Turn Assembly is described in more detail on page 3-31.
- ◆ Directional Arrow Auxiliary Signs (Texas MUTCD 2D.26)
  - Directional Arrow auxiliary signs are used to indicate the direction that a driver must follow to travel on the indicated route. Directional Arrow auxiliary signs are typically used only in Directional Assemblies, although similar type arrows are also used as a component in Destination and Combination stand-alone signs. The sign can display either a single- or double-headed arrow, as shown in Figure 3-10. The use of Directional Arrow auxiliary signs in a Directional Assembly is described on page 3-33.



Figure 3-9. Advance Turn Arrow Signs

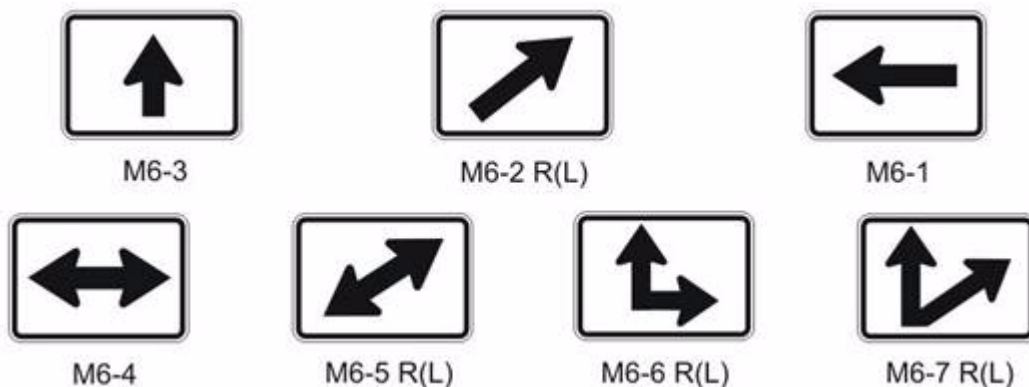

Figure 3-10. Directional Arrow Signs

## Double Arrow Sign

The double-headed arrow sign (M6-4), shown in Figure 3-10, can be used in directional assemblies only at certain types of intersections when all of the following conditions are met:

- ◆ Intersection is rural,
- ◆ Both roadways are two-lane conventional type,
- ◆ Intersection is simple, basically 90 degree crossing or tee,
- ◆ Highway directions are reasonably obvious with individual cardinal direction markers, and
- ◆ Minor road has mostly local traffic.

Figure 3-11 illustrates the application of a double-headed arrow under these circumstances.



Figure 3-11. Use of Double-Headed Arrow in Directional Assembly

### Special Design for Wide Directional Arrow Auxiliary Sign

Where two route signs share the same direction, a special type of arrow sign may be used. The special arrow sign extends across the width of both route signs. An example of this extra wide arrow sign is shown in Figure 3-12. The size for this arrow sign is 60x15 inches.



Figure 3-12. Extra Wide Directional Arrow Sign (M6-1T)

### Lane Designation Auxiliary Signs

**Purpose:** Lane Designation auxiliary signs are used to direct a motorist to the proper lane for making a turn or following a numbered route. A Lane Designation auxiliary sign is mounted below the route sign(s) to which it applies.

Lane Designation auxiliary signs are typically used in developed urban areas. They are only used when there are two or more through lanes in one direction. They may be used in a Junction Assembly (page 3-30) or as a separate assembly. Figure 3-13 illustrates Lane Use signs.

The Lane Designation assembly is normally erected in two consecutive blocks, usually the third and fourth blocks, in advance of the highway turn or junction with another highway.



Figure 3-13. Lane Use Auxiliary Signs



### Other Auxiliary Signs (Texas MUTCD, Section 2D.16 to 2D.24)

There are several other types of auxiliary signs that may be used with route signs. They are described below and illustrated in Figure 3-14.

- ◆ **ALTERNATE auxiliary sign (Texas MUTCD 2D.17):** The ALTERNATE auxiliary sign is used to identify a designated Alternate Highway. The ALTERNATE auxiliary sign is mounted above the route sign.
- ◆ **BUSINESS auxiliary sign (Texas MUTCD 2D.19):** The BUSINESS auxiliary sign is used to identify a designated Business Highway. The BUSINESS auxiliary sign is mounted above the route sign.
- ◆ **TRUCK auxiliary sign (Texas MUTCD 2D.20):** The TRUCK auxiliary sign is used to designate an alternate route for trucks to avoid congested areas or areas that have height or weight limitations. The TRUCK auxiliary sign is mounted above the route sign. TRUCK auxiliary signs are used as part of a Trailblazer Assembly.
- ◆ **TO auxiliary sign (Texas MUTCD 2D.21):** The TO auxiliary sign is used as a trailblazer to indicate the route to a nearby highway that is not located at the current intersection or interchange. The TO auxiliary sign is mounted above the route sign. TO auxiliary signs are used as part of a Trailblazer Assembly (page 3-35).
- ◆ **END auxiliary sign (Texas MUTCD 2D.22):** The END auxiliary sign is used to inform the motorist that the designated route is terminating. The END auxiliary sign is mounted above the route sign or above a sign for an alternative route.

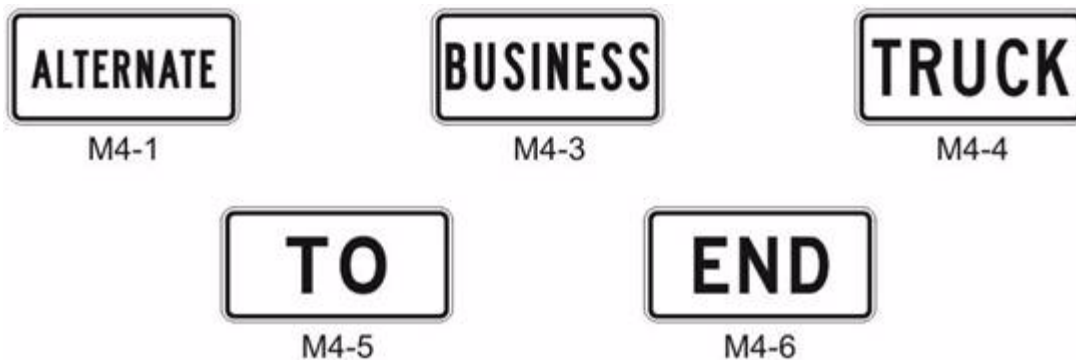

Figure 3-14. Other Auxiliary Signs

## Section 3

### Arrangement of Components

#### Introduction (Texas MUTCD, Section 2D.27)

Conventional guide sign assemblies are created by combining the various components described in the previous section. These components are used in a particular manner and arrangement to ensure uniformity for the driver. This section concentrates on illustrating how guide signs, particularly route signs, are to be arranged in different assemblies so that different classes of highways and/or directions of travel are consistent.

The following terminology is used in describing the arrangement of guide sign components:

- ◆ **Component:** The individual signs that are attached to a post or sign.
- ◆ **Unit:** A collection of components that present the information related to travel on a specific highway. A unit consists of a route sign and the auxiliary signs (if used) above and below the route sign. The typical unit consists of (from top to bottom): a cardinal direction sign, a route sign, and a directional arrow sign.
- ◆ **Assembly:** A collection of units that present information related to travel on all highways at or near a specific intersection.

#### Guide Sign Units

The first step in arranging guide sign components is to identify the individual units that must be presented at a given location. This is accomplished by identifying the route signs applicable to a given location and selecting the signs that should be used above and below the route sign. Signs with the same information (such as the same cardinal direction or arrow) should also be identified so that they might be combined within the assembly. Table 3-2 identifies the components that can be used in the upper and lower positions of a unit. Figure 3-15 provides examples of guide sign units.

### Arrangement Hierarchy

Once the units have been identified, hierarchal relationships are used to determine the position of the units within the assembly. The following steps are used to determine placement:

- ◆ Select arrangement pattern: horizontal, vertical, or combination of both.
- ◆ Identify units by direction.
- ◆ Identify highway class within a given direction.
- ◆ Identify highway number within a given class.

**Table 3-2: Components of a Guide Sign Unit**

Position	Possible Components
Upper	Cardinal Direction, Junction, Business, To, Alternate, End, Truck, By-Pass, Temporary
Middle	Route Sign
Lower	Directional Arrow, Advance Turn Arrow, Lane Use



Figure 3-15. Examples of a Guide Sign Unit

### Arrangement Pattern

Guide sign units may be arranged so that all units are side-by-side (horizontal), top-to-bottom (vertical), or a combination of both. Table 3-3 illustrates some of the combinations of arrangements that can be found when up to three units are displayed in an assembly and there is one direction of travel for each unit.

- ◆ Horizontal Arrangement - In a horizontal arrangement, all units are side-by-side. The horizontal arrangement is the best arrangement from a driver information standpoint, as the units are arranged in a manner that relates to the directions that a driver must turn (that is, a unit requiring a left turn is on the left side). Figure 3-16 provides examples of horizontal guide sign unit arrangements.

- ◆ Vertical Arrangement - In a vertical arrangement, all units are top-to-bottom. Vertical arrangements may be used when the available width for an assembly is restricted. When units are arranged vertically, additional space should be provided between units to help the driver distinguish between directions (see Layout Dimensions for Assemblies, page 3-23). Figure 3-17 provides examples of vertical guide sign unit arrangements.
- ◆ Combination of Horizontal and Vertical Arrangements - When there are three or more units, the assembly may be arranged in a manner that includes both side-by-side and top-to-bottom arrangements. To the extent possible, units should be arranged horizontally by direction. Units that share a common direction should be arranged vertically. In some cases, it may be necessary to include multiple directions in a single vertical stack. Figure 3-18 illustrates different possibilities for combination arrangements involving 3 or 4 units.

**Table 3-3: Arrangement of Units by Direction within an Assembly**

Number of Units Displayed	Arrangement of Units		
	Horizontal	Vertical	Combination
1		Not Applicable	Not Applicable
2			Not Applicable
3		Not Recommended	

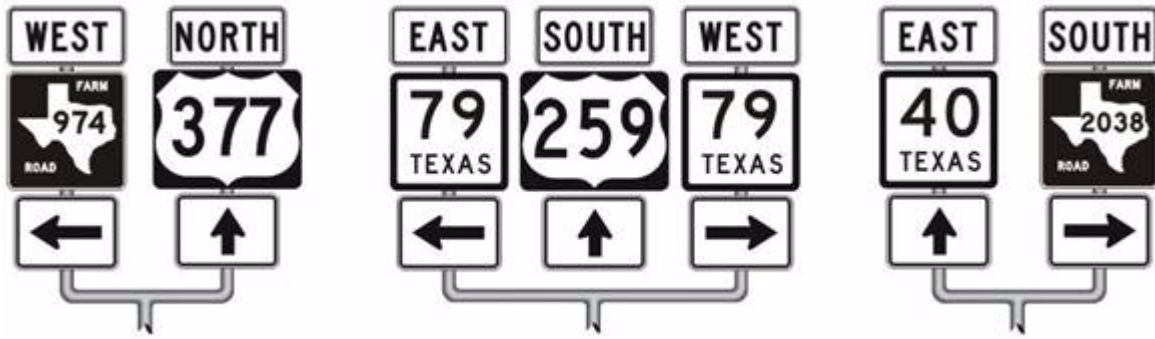

Figure 3-16. Horizontal Arrangement



Figure 3-17. Vertical Arrangement

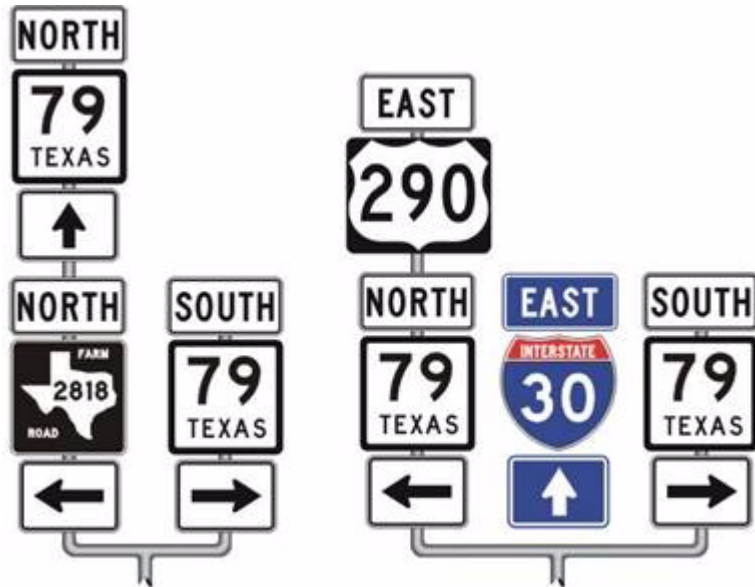

Figure 3-18. Combination Arrangement

### **Arrangement by Direction**

The initial grouping of units is by direction. This requirement applies regardless of class of highway or route number. Highway routes with a common direction may be combined with a single directional arrow sign.

- ◆ Directional Hierarchy for Horizontal Arrangement (left to right): Left, Through, Right.
- ◆ Directional Hierarchy for Vertical Arrangement (top to bottom): Through, Left, Right.

### **Arrangement by Class of Highway**

Within a given direction, route signs are arranged by highway classification. The higher class highway should be at the top or left. The following list indicates the hierarchy of highway classes, from the highest to the lowest.

- ◆ Interstate and Toll Interstate
- ◆ U.S. Highway and Toll U.S. Highway
- ◆ U.S. Highway Alternate
- ◆ U.S. Highway Spur
- ◆ OSR, NASA, State Highway, and Toll State Highway
- ◆ State Highway Alternate
- ◆ Loop, Beltway, or Spur
- ◆ Business Interstate Loop or Business Interstate Spur
- ◆ U.S. Highway Business
- ◆ State Highway Business or Farm (or Ranch) to Market Road Business
- ◆ Farm to Market Road or Ranch to Market Road
- ◆ Ranch Road
- ◆ Park Road
- ◆ Recreational Road
- ◆ Recreational Road Spur
- ◆ Farm to Market Road Spur or Ranch to Market Road Spur
- ◆ Ranch Road Spur

### **Arrangement by Highway Number**

Within a direction and highway class, route signs are arranged by number. Lower numbers should be at the top or left.

### Examples of Assembly Arrangements

Figures 3-19, 3-20, and 3-21 illustrate arrangements of route sign assemblies for intersections with 2, 3, and 4 route signs, respectively.

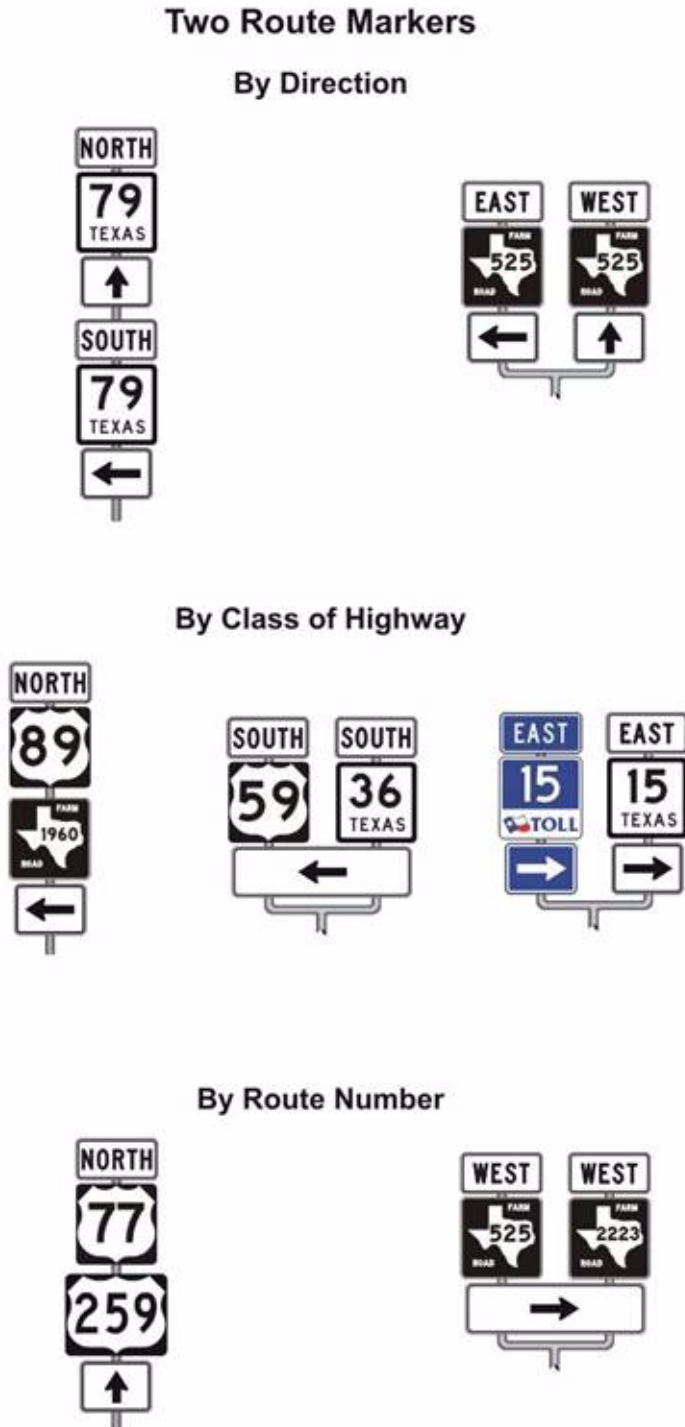
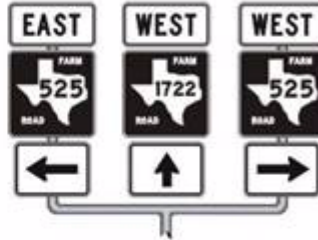

Figure 3-19. Route Sign Assembly for Intersection with Two Route Signs

### Three Route Markers

#### By Direction



#### By Class of Highway



#### By Route Number

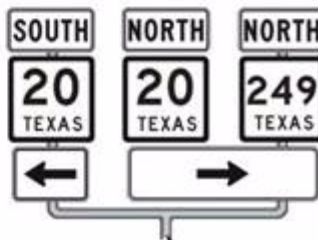
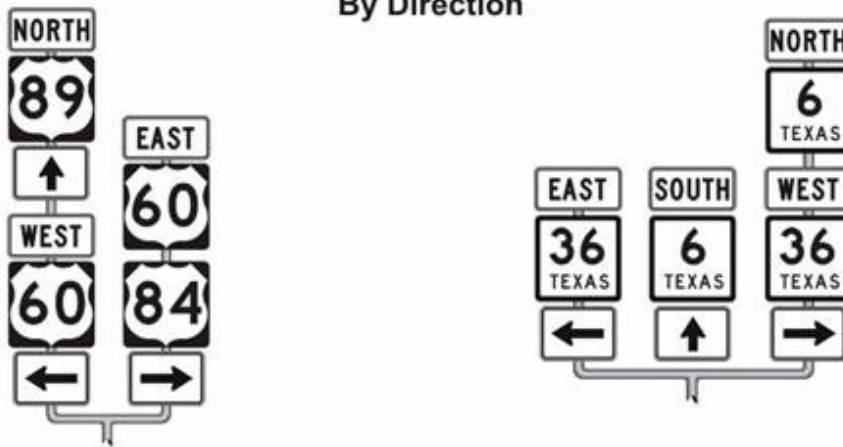

Figure 3-20. Route Sign Assembly for Intersection with Three Route Signs



### Four Route Markers

#### By Direction



#### By Class of Highway



#### By Route Number

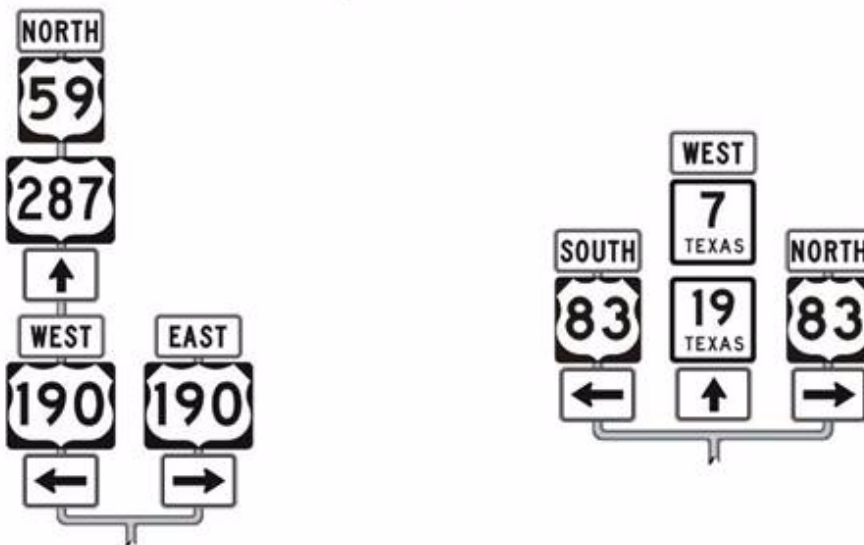

Figure 3-21. Route Sign Assembly for Intersection with Four Route Signs

### Layout Dimensions for Assemblies

The following dimensions should be used for the layout of the individual components and units in an assembly. These dimensions are illustrated in Figure 3-22.

- ◆ The space between the individual components of a unit should be approximately 1 inch.
- ◆ There should be approximately 4 inches between individual units arranged vertically in an assembly.

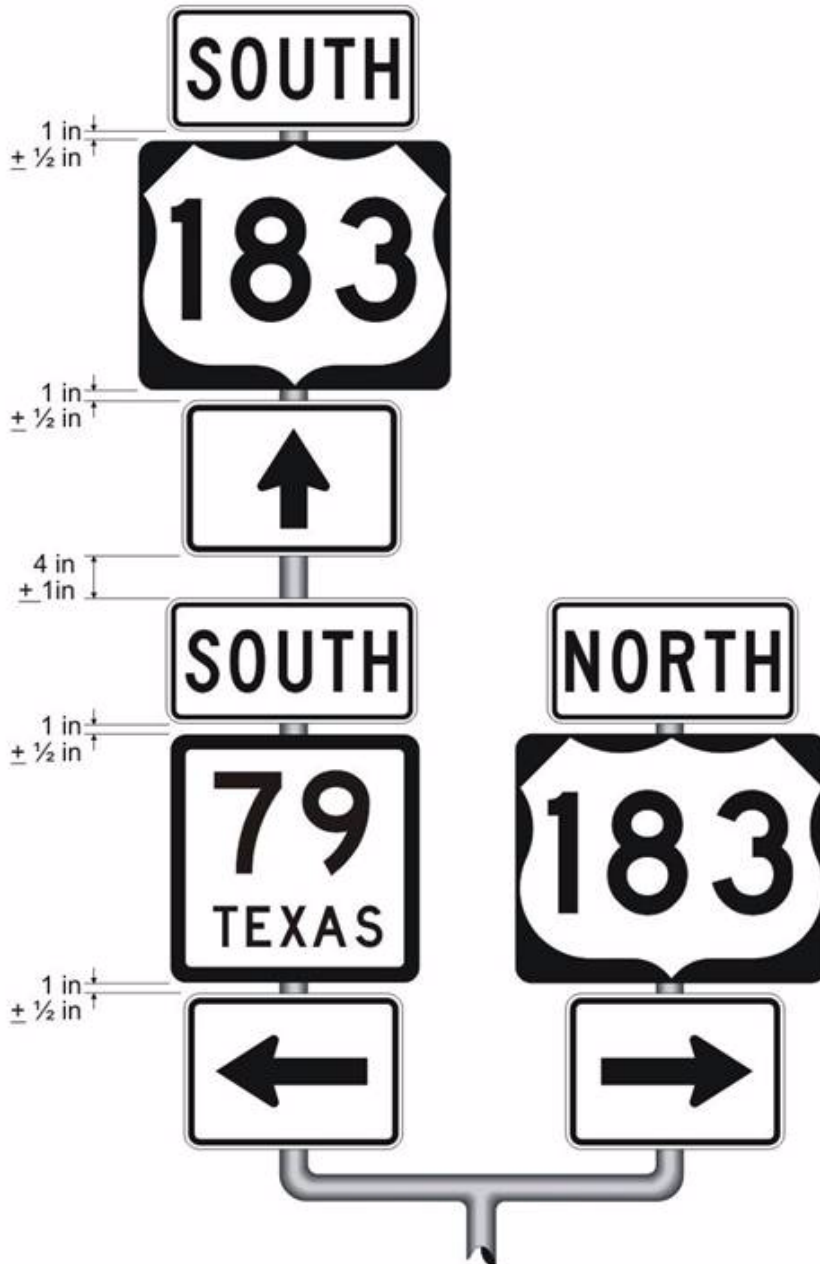

Figure 3-22. Layout Dimensions for Assemblies

### Route Sign Assembly Layout Flow Chart

The flow chart provided in Figure 3-23, and the components of the chart in Figures 3-24 to 3-27, combines the previously described criteria for route sign arrangement and allows for a simple determination of how the route sign assembly may be arranged. The flow chart uses the features of the intersection approach as criteria for arranging the route sign assembly. These intersection approach features include number of directions, number of highway classes, number of route signs per highway class, and number of cardinal direction signs to be shown in the assembly.

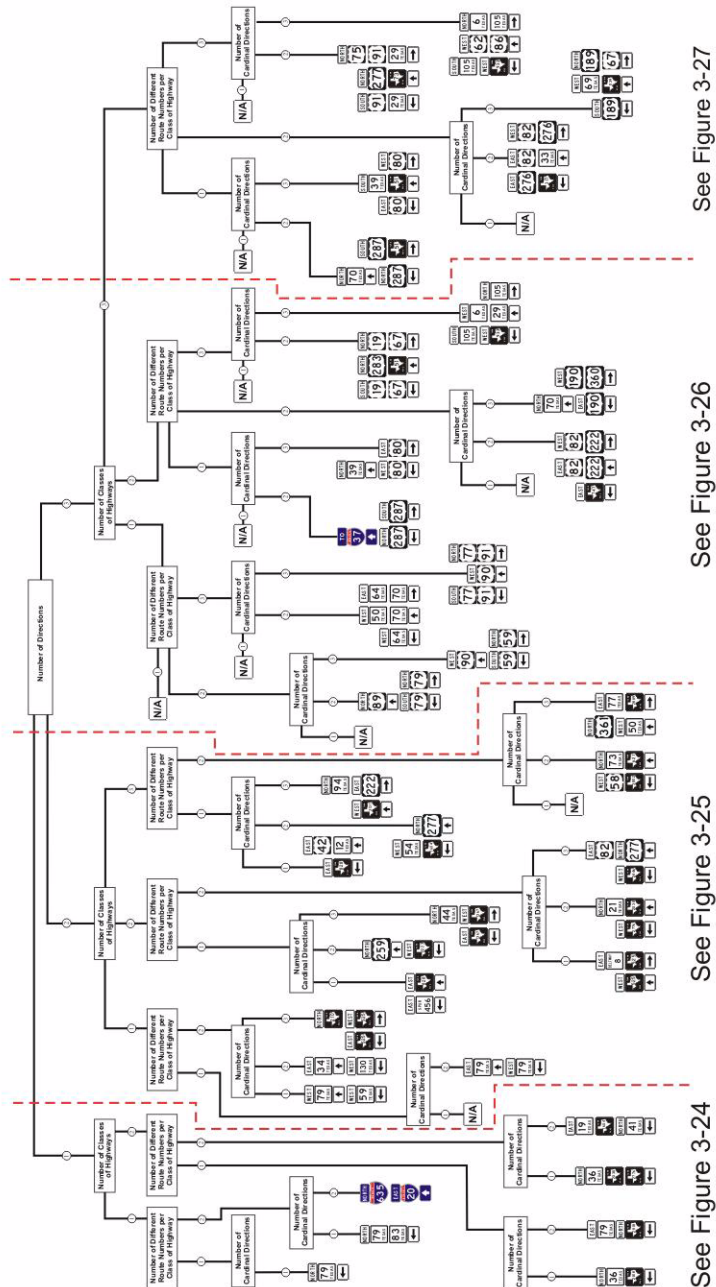

Figure 3-23. Route Sign Assembly Layout Master Flow Chart

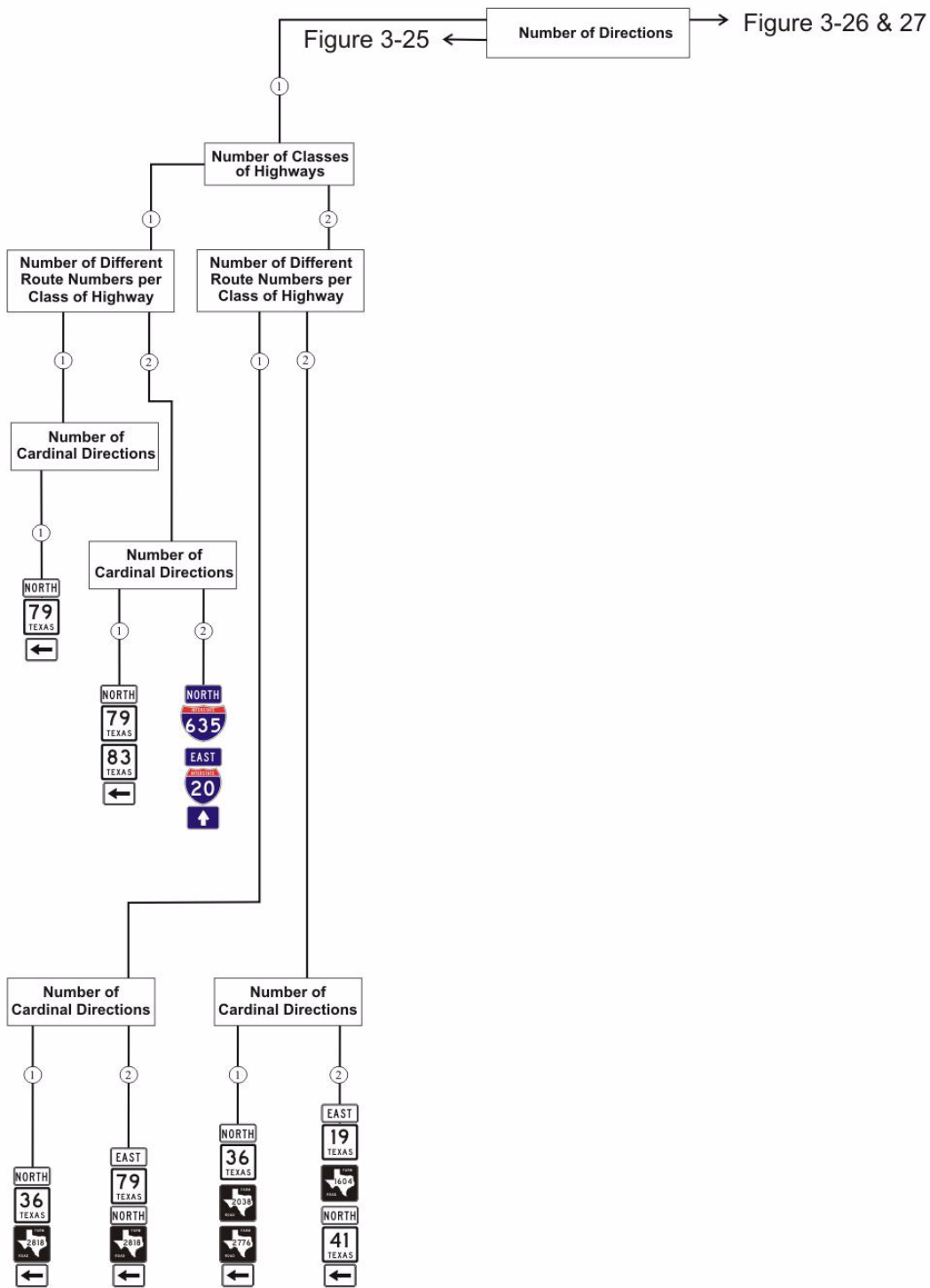

Figure 3-24. Route Sign Assembly Layout - Highway with One Direction

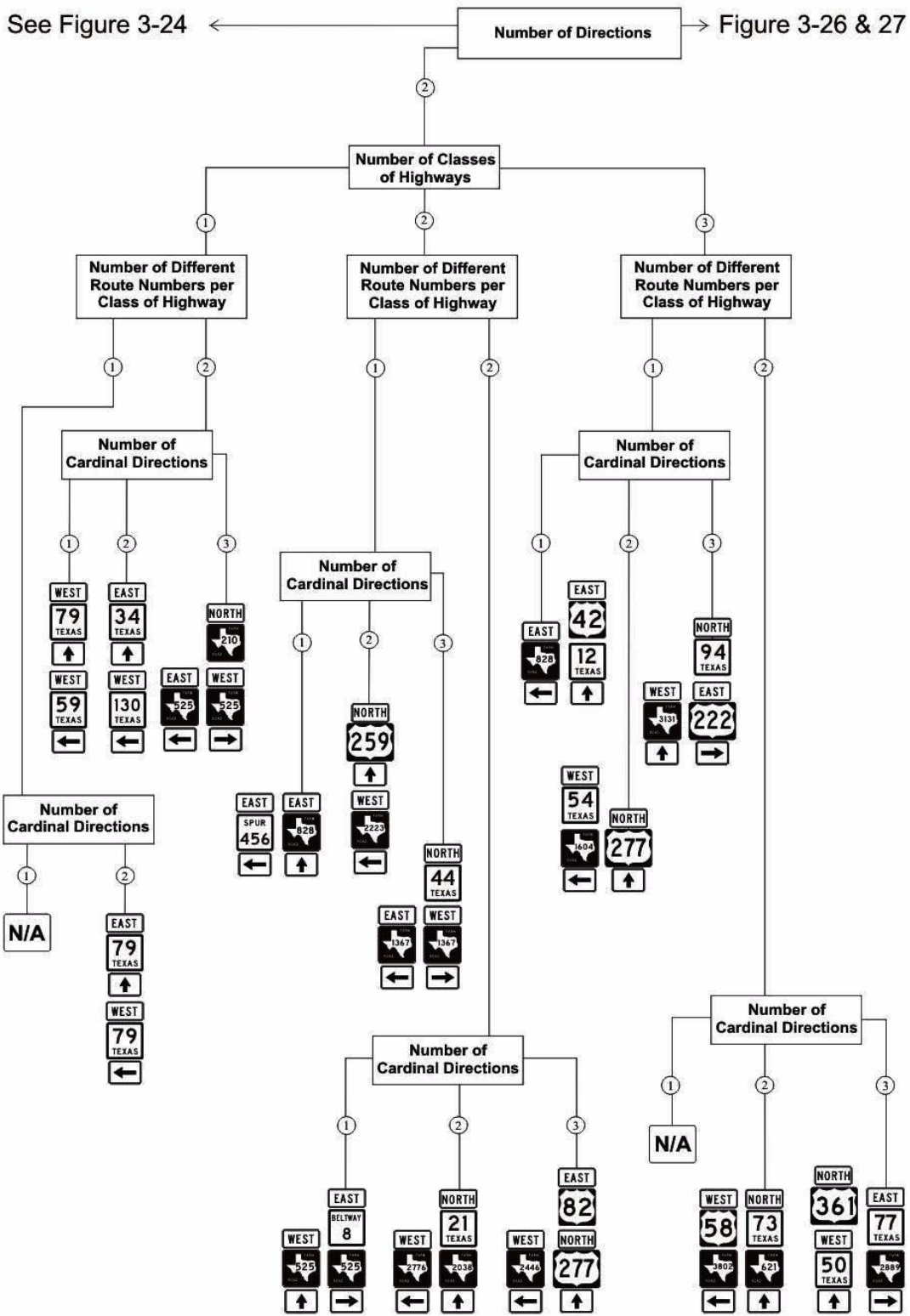

Figure 3-25. Route Sign Assembly Layout - Highway with Two Directions





## Section 4

### Guide Sign Assemblies

#### Introduction

This section describes the purpose of several different types of conventional guide sign assemblies. These assemblies include:

- ◆ **Junction Assembly:** Provides advance notice of an intersection with another highway.
- ◆ **Advance Route Turn Assembly:** Provides advance notice that a turn is necessary to remain on the indicated highway.
- ◆ **Directional Assembly:** Provides directional information about one or more highways at an intersection.
- ◆ **Confirming or Reassurance Assembly:** Provides confirmation information about the highway after passing through the intersection.
- ◆ **Trailblazer Assembly:** Provides directional information to a highway not located at the current intersection.

Elements associated with each type of assembly are addressed in this section. The placement of assemblies is addressed in Chapter 5.



**Junction Assembly (Texas MUTCD Section 2D.28)**

**Purpose:** A Junction Assembly is used to provide advance notice of an intersection with another highway. Junction signs are located in advance of intersections where a marked route is intersected or joined by another marked route.

**Components:** The following components make up a Junction Assembly:

- ◆ Standard: Junction auxiliary sign and route sign.
- ◆ Optional: Cardinal Direction auxiliary sign, Lane Designation auxiliary sign, and Distance plaque.

Where two or more routes are to be indicated, one Junction sign can be used with both route signs, if both route signs have the same background color. Typical Junction Assemblies are illustrated in Figure 3-28.

In some cases, it may be appropriate to provide a Combination Junction Assembly. This sign combines junction information for two or more routes into a single sign. Additional information that may be presented in a Combination Junction Assembly includes cardinal direction, directional arrow, destination cities, and/or a distance to the junction. Figure 3-5 illustrates some variations of the Combination Junction sign.

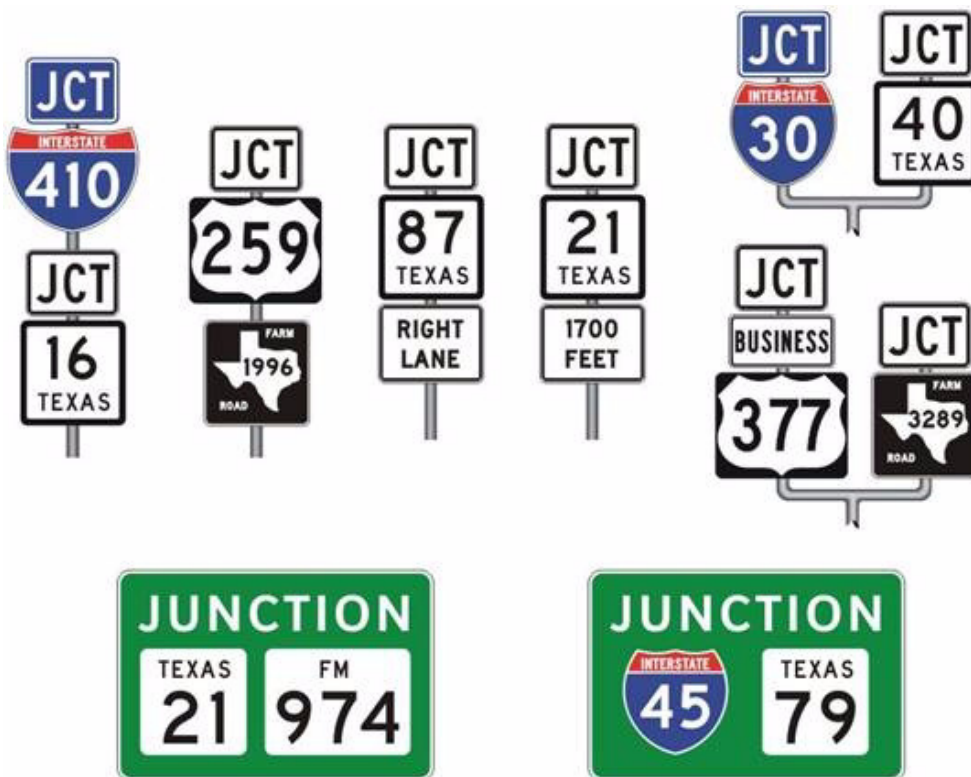

Figure 3-28. Typical Junction Assemblies

### Advance Route Turn Assembly (Texas MUTCD Section 2D.29)

**Purpose:** The Advance Turn Assembly provides advance notice of the need to turn at the intersection in order to remain on the indicated highway.

**Components:** The following components make up an Advance Route Turn Assembly:

- ◆ Standard: Route sign and Advance Turn auxiliary sign.
- ◆ Optional: Cardinal Direction auxiliary sign.

Figure 3-29 illustrates an Advance Route Turn sign assembly.



Figure 3-29. Advance Route Turn Sign Assembly

Section 2D.29 of the Texas MUTCD requires an Advance Route Turn Assembly to be used (shall condition) where a turn must be made at an intersection to remain on the indicated route. Figure 3-30 illustrates these two situations where an Advance Route Turn Assembly is required.

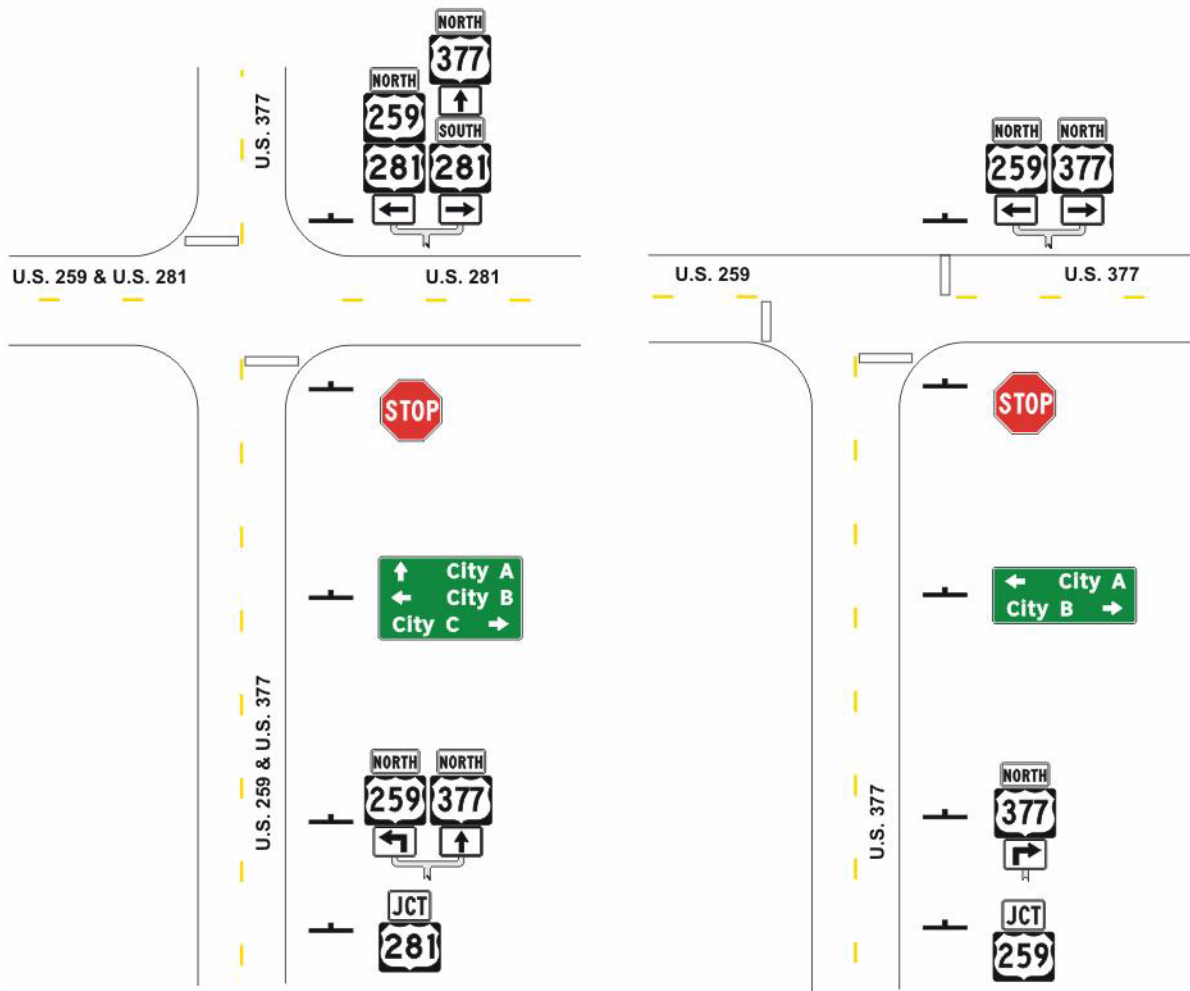

Figure 3-30. Required Applications of Advance Route Turn Assembly

**Directional Assembly (Texas MUTCD Section 2D.30)**

**Purpose:** The Directional Assembly is used at an intersection to provide information about travel on one or more intersecting highways.

**Components:** The following components make up a Directional Assembly:

- ◆ Standard: Route sign and Directional Arrow auxiliary sign.
- ◆ Optional: Cardinal Direction auxiliary sign.

Figure 3-31 illustrates a Directional Assembly.

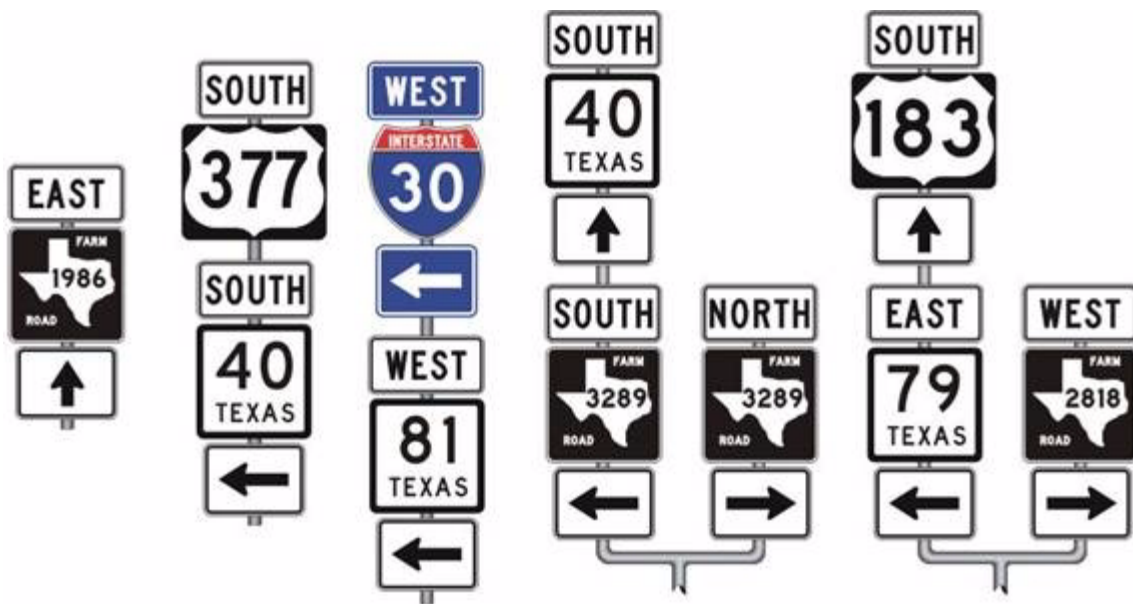

Figure 3-31. Directional Assembly

The following is a list of preferred locations for Directional assemblies:

- ◆ Directional assemblies are located on the near right-hand corner of intersections with no control or signal control.
- ◆ Directional assemblies are located on the far right-hand corner of intersections with Stop or Yield control.
- ◆ At major intersections and at Y or offset intersections, it is desirable to install additional assemblies on the far right-hand or left-hand corner of the intersection to confirm the near-right-hand side assembly.
- ◆ When a near-corner position is not practical, the far right-hand corner is the preferred alternative location. Oversize components may be appropriate to improve legibility.
- ◆ Where unusual conditions exist, the location of a Directional assembly is based on engineering judgment with the goal being to provide the best possible combination of view and safety.

### Confirming or Reassurance Assembly (Texas MUTCD Section 2D.31)

**Purpose:** The Confirming or Reassurance Assembly is used beyond an intersection to confirm the highway and direction to the driver after departing the intersection or interchange. The Confirming or Reassurance Assembly is also used at regular intervals between intersections to reassure drivers of the route they are traveling on.

**Components:** The following components make up a Confirming or Reassurance Assembly:

- ◆ Standard: Cardinal Direction auxiliary sign and Route sign.
- ◆ Optional: Texas Reference marker.

Figure 3-32 illustrates a Confirming or Reassurance Assembly.



Figure 3-32. *Confirming or Reassurance Assembly*

A Texas Reference marker may be incorporated into a Confirming or Reassurance Assembly. See page 3-36 for more information about the use of the Texas Reference marker.

**Trailblazer Assembly (Texas MUTCD Section 2D.32)**

**Purpose:** The Trailblazer Assembly is used at an intersection to indicate the direction to a highway not located at that intersection. Trailblazer Assemblies may also be used at non-intersection locations to direct drivers to the indicated highway.

**Components:** The following components make up a Trailblazer Assembly:

- ◆ Standard: TO auxiliary sign, Route sign, Directional Arrow auxiliary sign.
- ◆ Optional: Cardinal Direction auxiliary sign.

Figure 3-33 illustrates a Trailblazer Assembly.

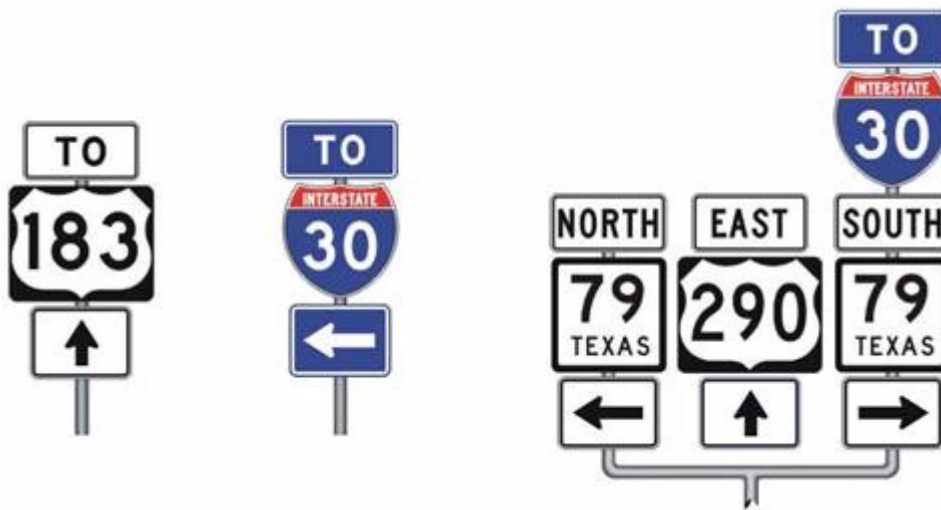

Figure 3-33. Trailblazer Assembly

A Trailblazer Assembly may be incorporated into the Directional Assembly at an intersection as shown in the assembly on the right side of Figure 3-33.

---

### Texas Reference Marker Assembly

**Purpose:** The Texas Reference Marker assembly provides the tie in the field to the Texas Reference Marker System. These sign installations are provided primarily for TxDOT use in referencing locations on a highway.

**Components:** The following components make up a Reference Marker installation:

- ◆ Standard: Route sign, Texas Reference marker (front and back of post).
- ◆ Optional: Cardinal Direction auxiliary sign.

**Installation:** The following factors describe how the Texas Reference marker should be installed.

- ◆ It is located approximately every 2 miles on a highway.
- ◆ The preferred installation is:
  - On alternating sides of an undivided highway (4 miles between installations on the same side of the highway).
  - On both sides of a divided highway (2 miles between installations on the same side of the highway). When installed on both sides of a divided highway, one side is the primary installation. The secondary installation must be exactly opposite of the primary installation.
- ◆ It is installed on both the front and back of the post for all installations.
- ◆ A reference marker should not be installed on the approach to an intersection (i.e., a reference marker installation should not be located between the intersection and the first sign informing the driver of the intersection, such as the Divided Highway Ahead or Junction sign).
- ◆ On concurrent (or overlapping) routes, the reference marker numbers for the higher class highway are used (see highway hierarchy on page 3-19). If the concurrent highways are of the same class, the reference marker numbers for the lower-numbered route are used.

Figure 3-34 illustrates installation of a Texas Reference Marker.

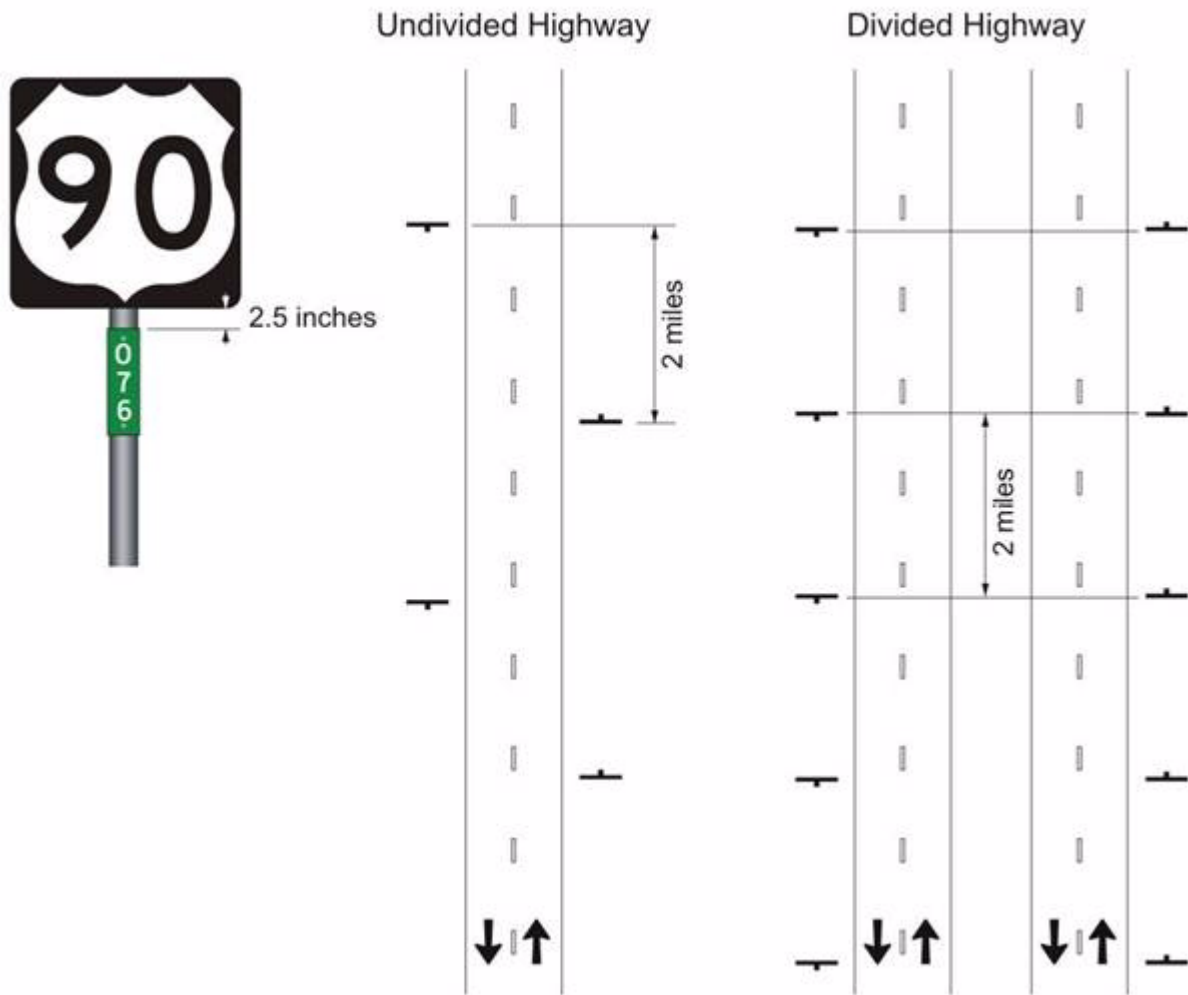

Figure 3-34. Texas Reference Marker Assembly



## Section 5

### Stand-Alone Signs

#### Introduction

This section describes the purpose of different types of stand-alone guide signs. These guide signs are individually designed for a specific location. The types of stand-alone signs include:

- ◆ Destination Signs: Provides guidance information in the form of a city name (destination) and the direction to the city. This type of sign is located in advance of an intersection.
- ◆ Distance Signs: Indicates the distance to the city shown on the sign. It is located beyond an intersection, on routes leaving a municipality, and at intervals between highway intersections.

### Destination Signs (Texas MUTCD Section 2D.33, 2D.34 and 2D.35)

**Purpose:** The Destination sign is used in advance of an intersection to show the direction a driver should turn at the intersection to go to the indicated destination(s). The destinations shown in a Destination sign can be a city, town, village, highway junction, or other traffic generator. Normally, not more than three destinations are used on a Destination sign.

**Components:** The following components make up a Destination sign:

- ◆ Standard: Destination name and directional arrow.
- ◆ Optional: None

Figure 3-35 illustrates Destination signs.



Figure 3-35. Destination Signs

Destination signs are typically used at the following locations:

- ◆ at the intersection of two numbered highway routes, and
- ◆ at points where they serve to direct traffic from highway routes to the business section of towns, or to other destinations reached by unnumbered routes.

**Distance Signs (Texas MUTCD Section 2D.33, 2D.36 and 2D.37)**

**Purpose:** The Distance sign is used to indicate the distance to the destination(s) shown in the sign. The destinations shown in a Distance sign can be a city, town, village, or other traffic generator. Not more than three destinations are used on a Distance sign.

**Components:** The following components make up a Distance sign:

- ◆ Standard: Destination name and distance.
- ◆ Optional: None.

Figure 3-36 illustrates Distance signs.



Figure 3-36. Distance Signs

Distance signs are typically used at the following locations:

- ◆ on the departures from the intersection of two numbered highway routes,
- ◆ on important routes leaving a municipality, or
- ◆ at periodic intervals between destinations in rural areas.

**Distance Shown:** The distance shown in a Distance sign is the distance from the sign to a permanent landmark in the center of the downtown area such as the courthouse. If the city or community has no well-defined central area or central business district, the distance shown is to the point where it appears that most drivers would feel that they are in the center of the community in question.

# Chapter 4

## Lateral Placement and Height

### Contents:

[Section 1 — Overview](#)

[Section 2 — Lateral Placement](#)

[Section 3 — Lateral Placement at Intersections](#)

[Section 4 — Sign Height](#)

---

## Section 1

### Overview

#### Introduction

The lateral placement and height of signs affect both the operational and safety performance of signs. Signs that are too far from the edge of the road or too high may not be in the drivers' cone of vision. Furthermore, they may not be able to retroreflect sufficient light at night to be legible to drivers. Signs that are too close to the edge of the travel way may have a higher probability of being hit by vehicles leaving the travel way.

This chapter illustrates the principles for the distance that signs should be placed from the edge of the travel lane or shoulder and how high signs should be placed above the roadway or ground. Several different figures provide illustrations of different situations that can affect the lateral placement of signs or sign height.

#### Terminology Used in the Field Book

Figure 4-1 illustrates how the following terms are used throughout the field book. It also identifies the point of reference from which to measure the lateral offset. Part 1 of the Texas MUTCD contains additional definitions.

- ◆ **Traveled Way:** The portion of roadway for the movement of vehicles, exclusive of the shoulders, berms, sidewalks, and parking lanes.
- ◆ **Shoulder:** For determining the lateral offset of a sign, it is the paved portion of the highway that is outside the traveled way.
- ◆ **Front slope:** The portion of the ditch that is on the road side of the flow line.
- ◆ **Ditch:** An area centered on a flow line that is intended to drain water.
- ◆ **Back slope:** The portion of the ditch that is on the opposite side of the flow line from the road.
- ◆ **Edge of travel lane:** If an edge line is present, it is measured from the outside edge of the edge line. If there is no edge line, it is measured from the edge of pavement.



Figure 4-1. Illustration of Terminology

## Section 2

### Lateral Placement

#### Introduction

Proper lateral placement of a sign:

- ◆ Improves the visibility of the sign, and
- ◆ Reduces the probability of being hit by vehicles leaving the roadway.

#### Locating Sign Posts Close to One Another

Figure 4-2 illustrates that no more than two sign supports should be located within a 7 ft circle.

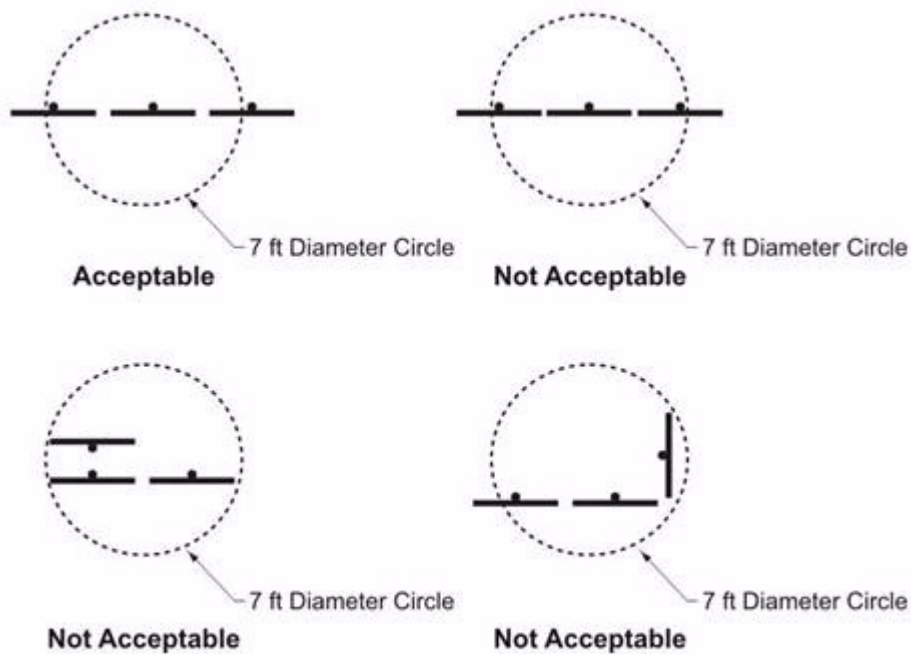

No more than 2 sign posts should be located within a 7 ft circle

Figure 4-2. Placement of Signs within 7 ft Circle

## Lateral Placement

Highway cross-section is the primary criteria affecting the lateral placement of signs. The key cross-section factors affecting the lateral placement are whether a roadway has no shoulder, a narrow shoulder, a wide shoulder, guardrail, or curb-and-gutter.

The following define narrow and wide shoulders:

- ◆ **Narrow shoulder:** A shoulder that is 6 ft or less in width.
- ◆ **Wide shoulder:** A shoulder that is more than 6 ft wide.

Where possible, do not place sign posts in the flow line of a ditch or drainage channel.

Section 2A.19 and Figure 2A-1 of the 2006 Texas MUTCD describe the lateral placement requirements for signs. Figures 4-3 through 4-9 on the following pages illustrate typical situations for the lateral placement of signs. Section 3 contains additional information about lateral placement of signs at intersections.

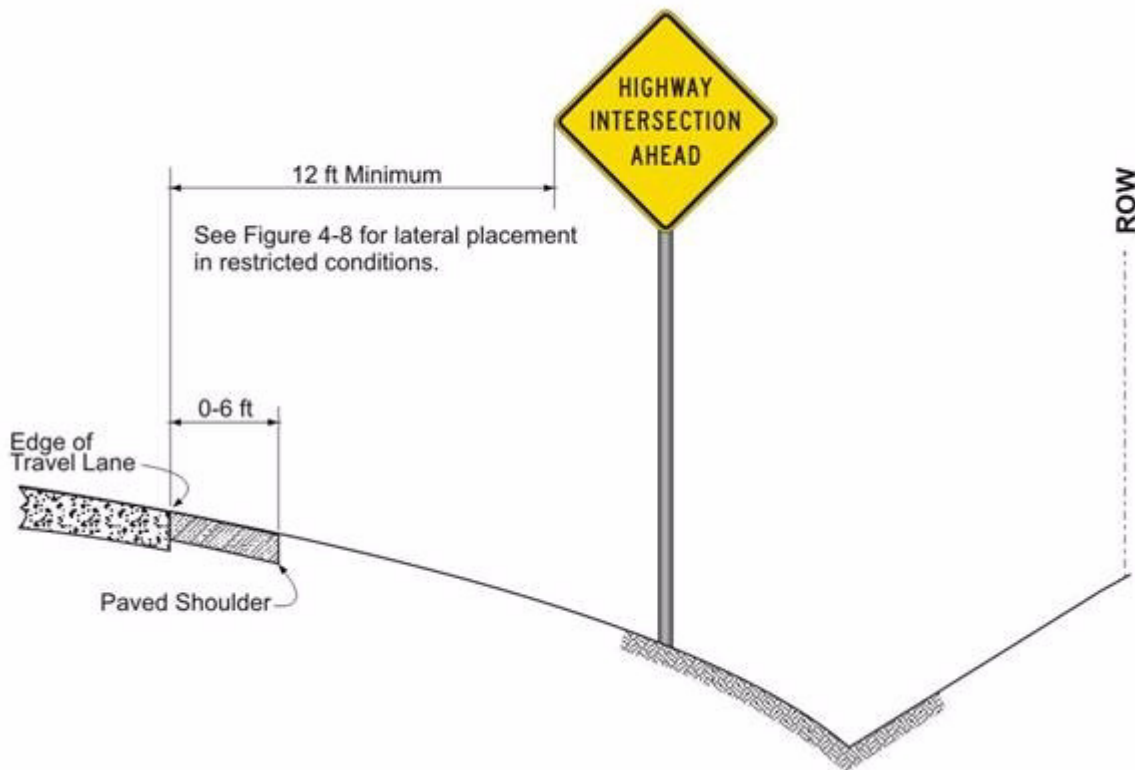

Figure 4-3. Lateral Sign Placement with No Shoulder or Narrow Shoulder



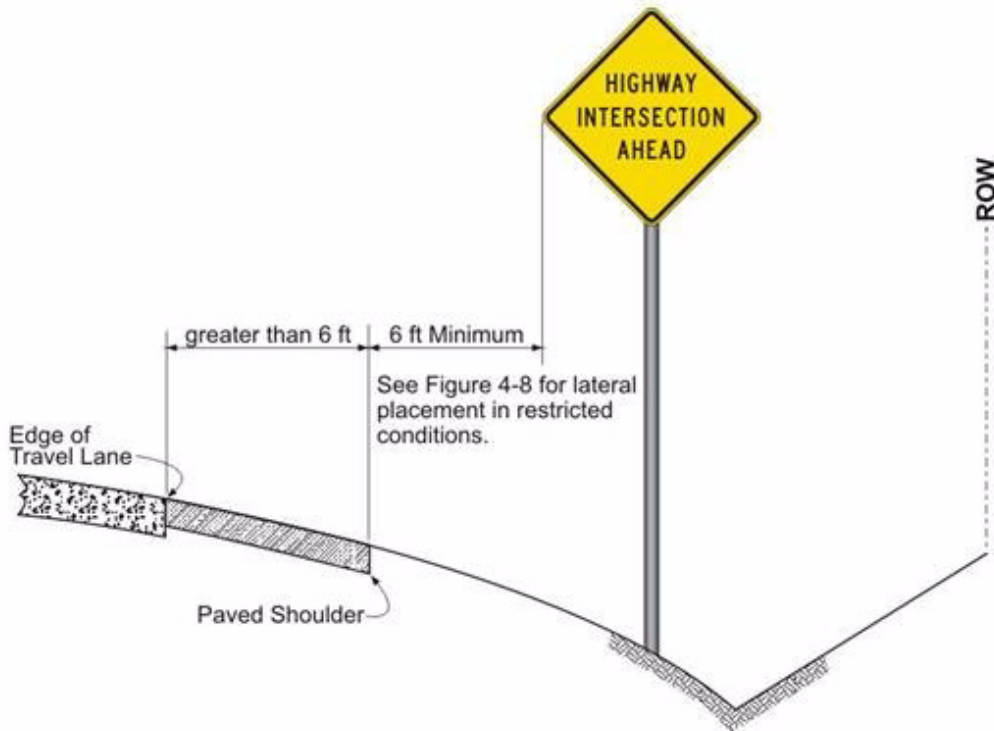

Figure 4-4. Lateral Sign Placement with Wide Shoulder

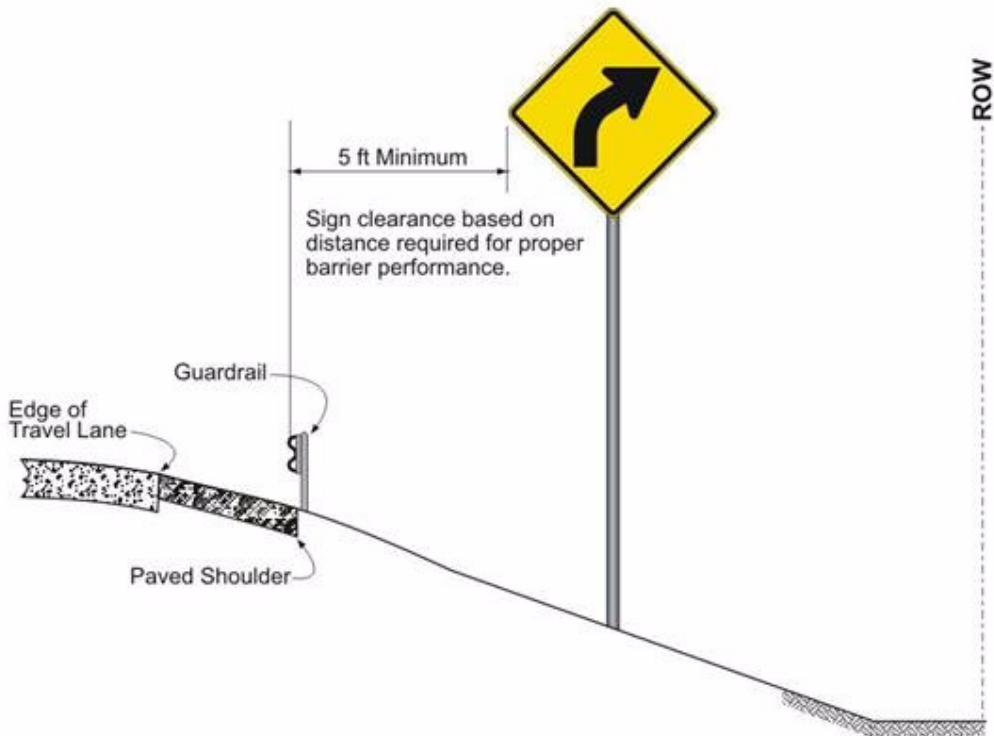

Figure 4-5. Lateral Sign Placement with Guardrail

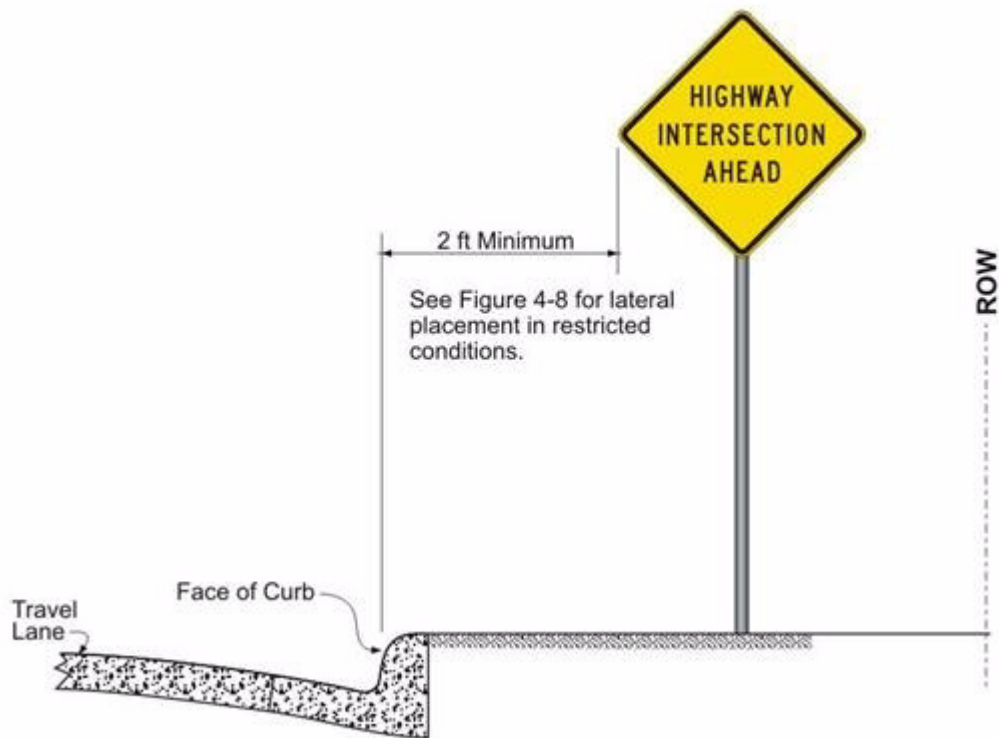

Figure 4-6. Lateral Sign Placement with Curb and Gutter

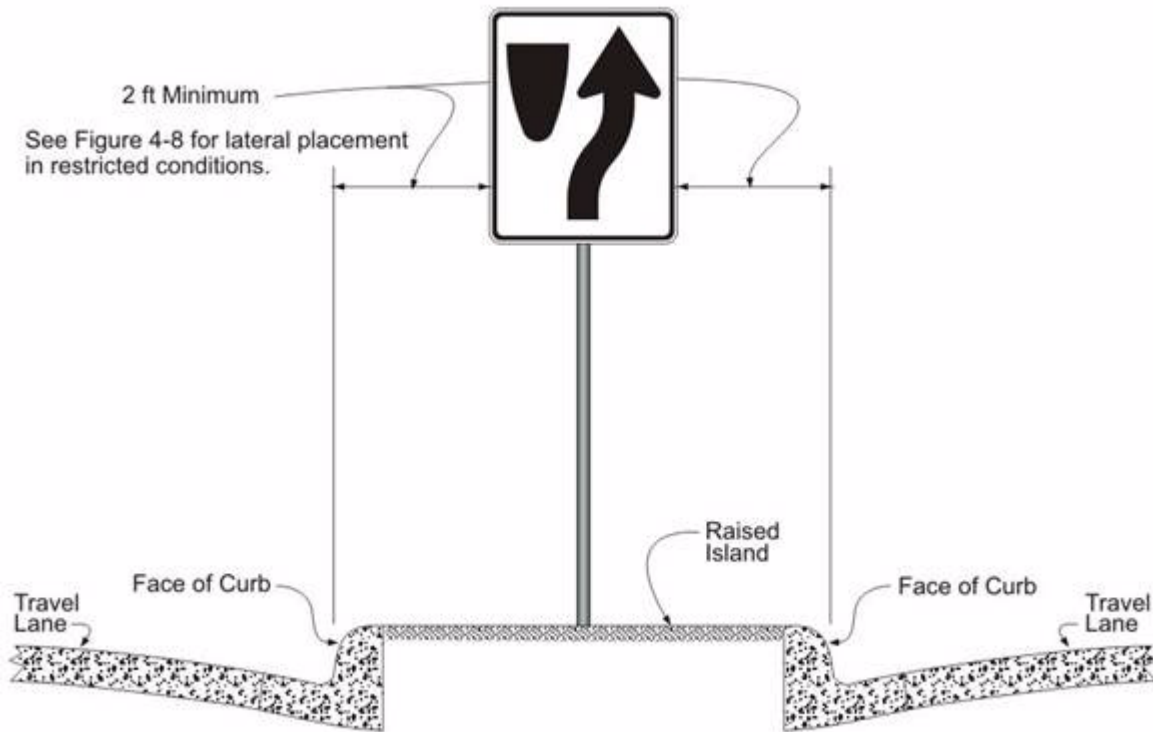

Figure 4-7. Lateral Sign Placement with Raised Island

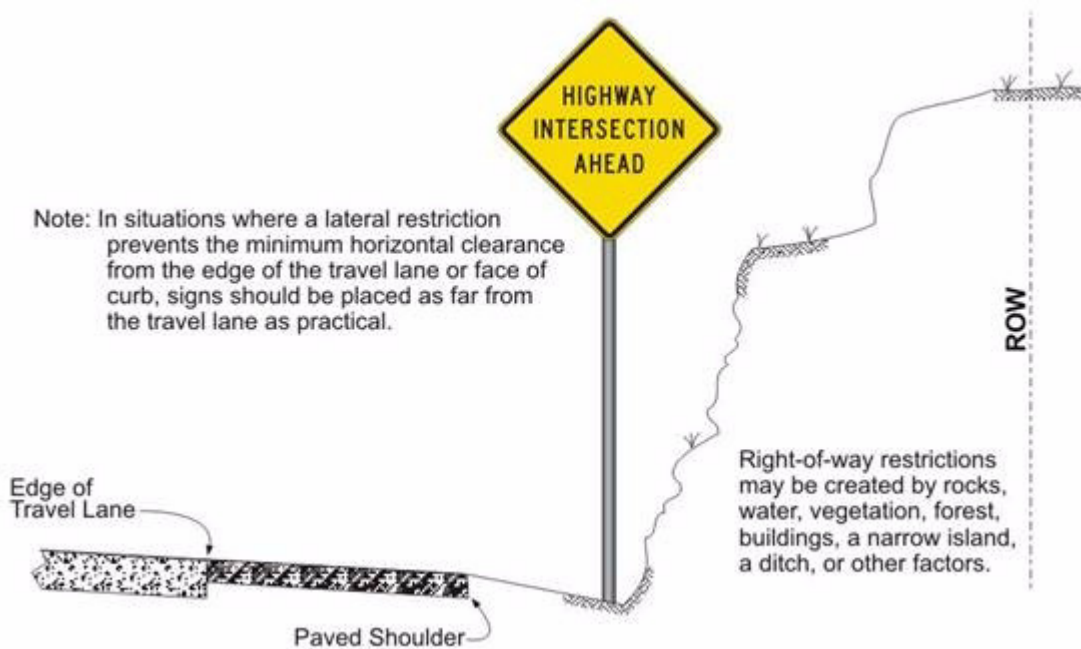
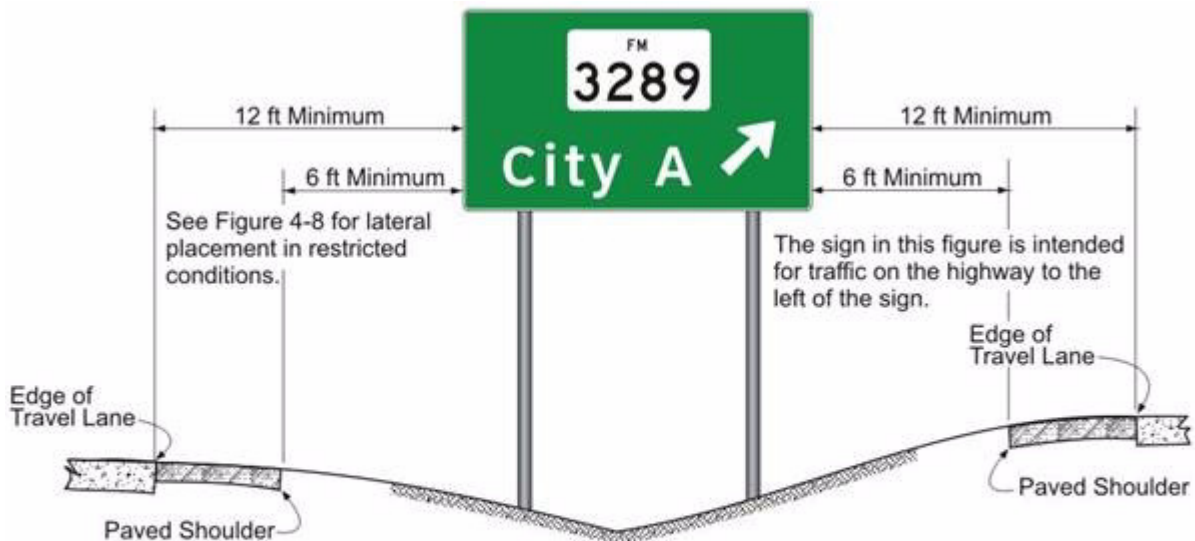

Figure 4-8. Lateral Sign Placement in Restricted Right-of-Way



In a situation where a sign is located between two roadways and where minimum lateral placement cannot be achieved for both roadways, preference should be given to placing the sign farther from the high volume or high speed roadway.

Figure 4-9. Lateral Sign Placement between Two Roadways

## **Section 3**

### **Lateral Placement at Intersections**

#### **Introduction**

Figures 4-10 through 4-14 on the following pages illustrate additional lateral placement situations for Stop and Yield signs and other intersection-related situations. Sections 2B.06, Section 2B.10, and Figure 2A-2 of the 2006 Texas MUTCD describe the requirements for the placement of Stop and Yield signs.

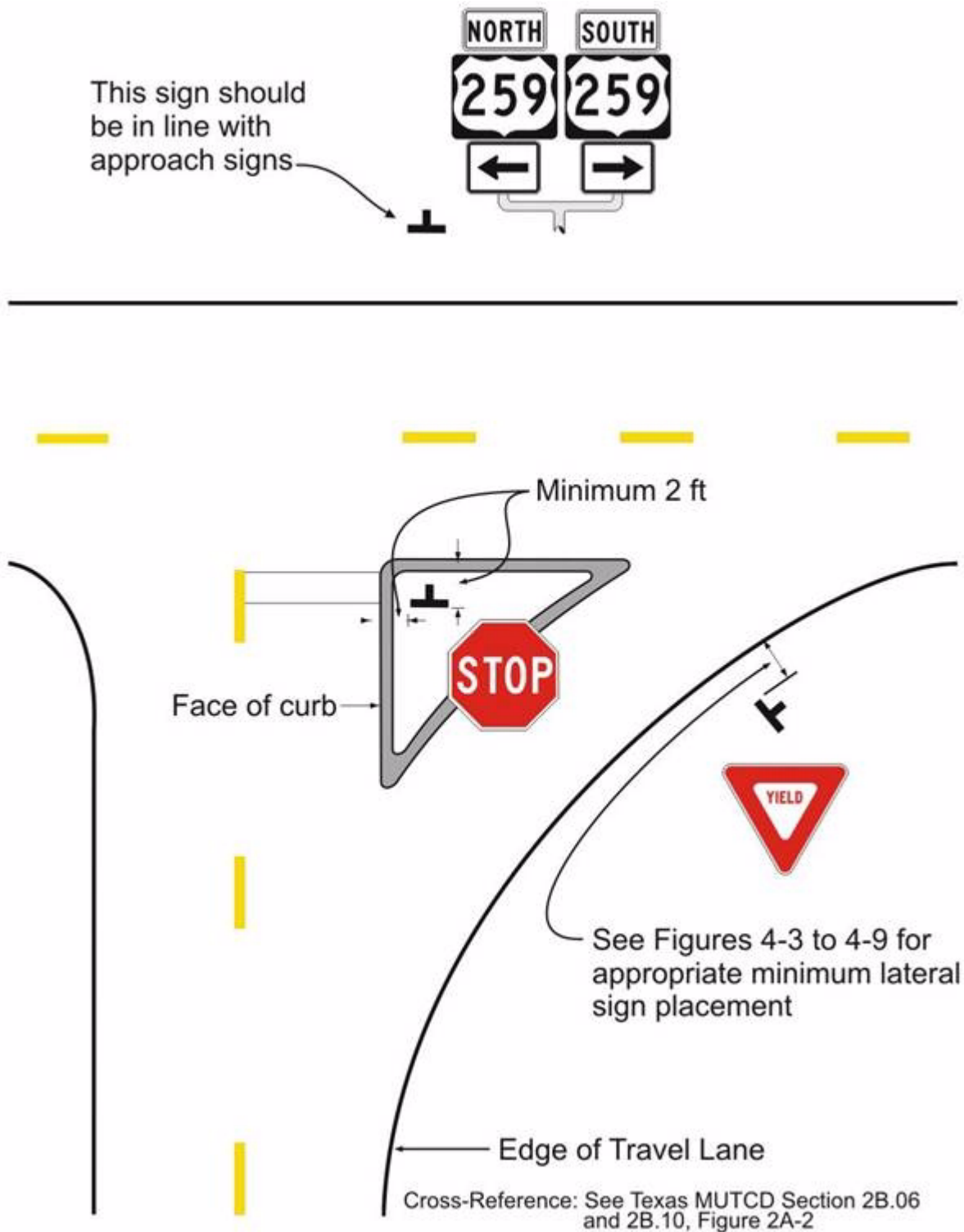

Figure 4-10. Stop/Yield Sign Lateral Placement at a Channelized Intersection

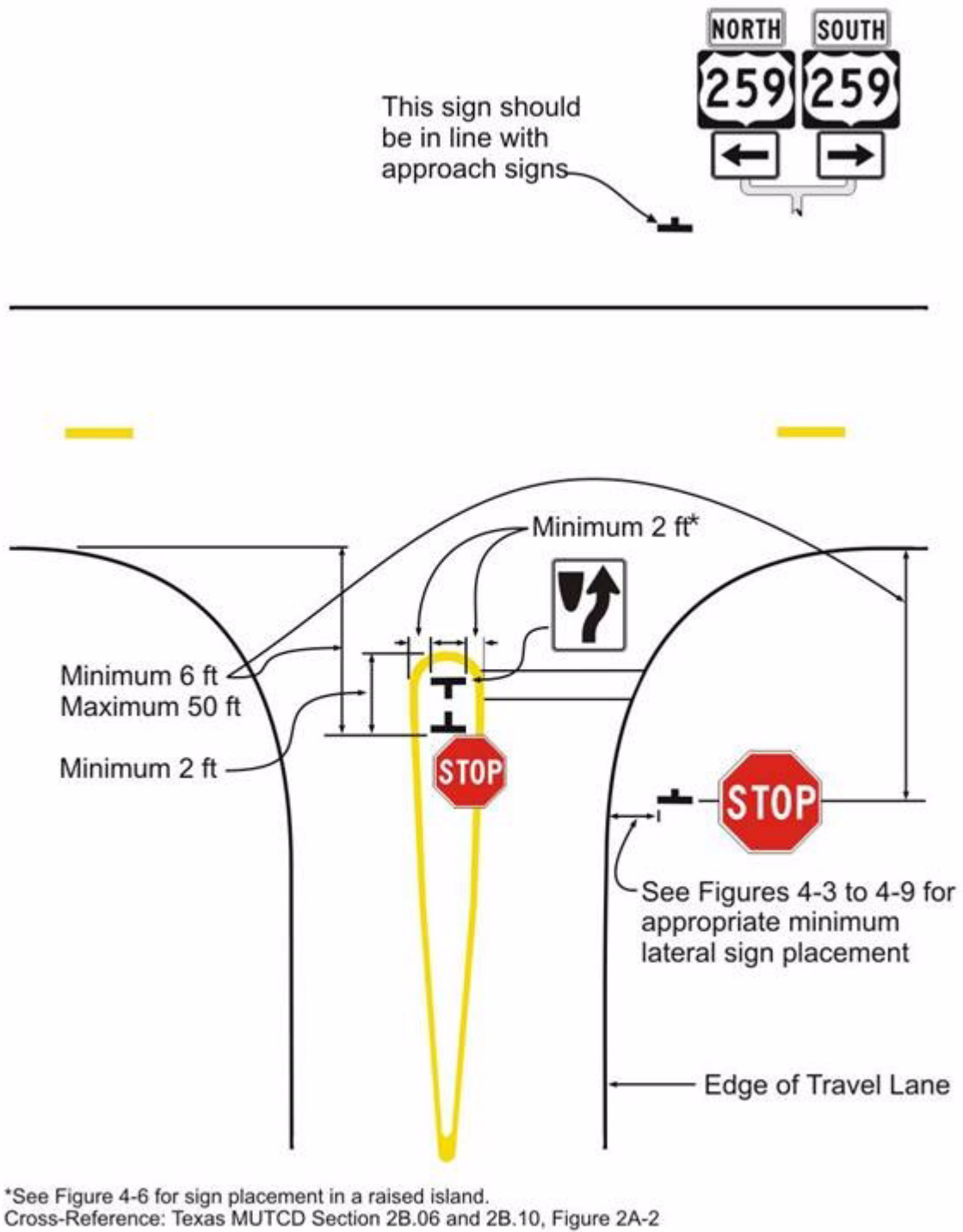
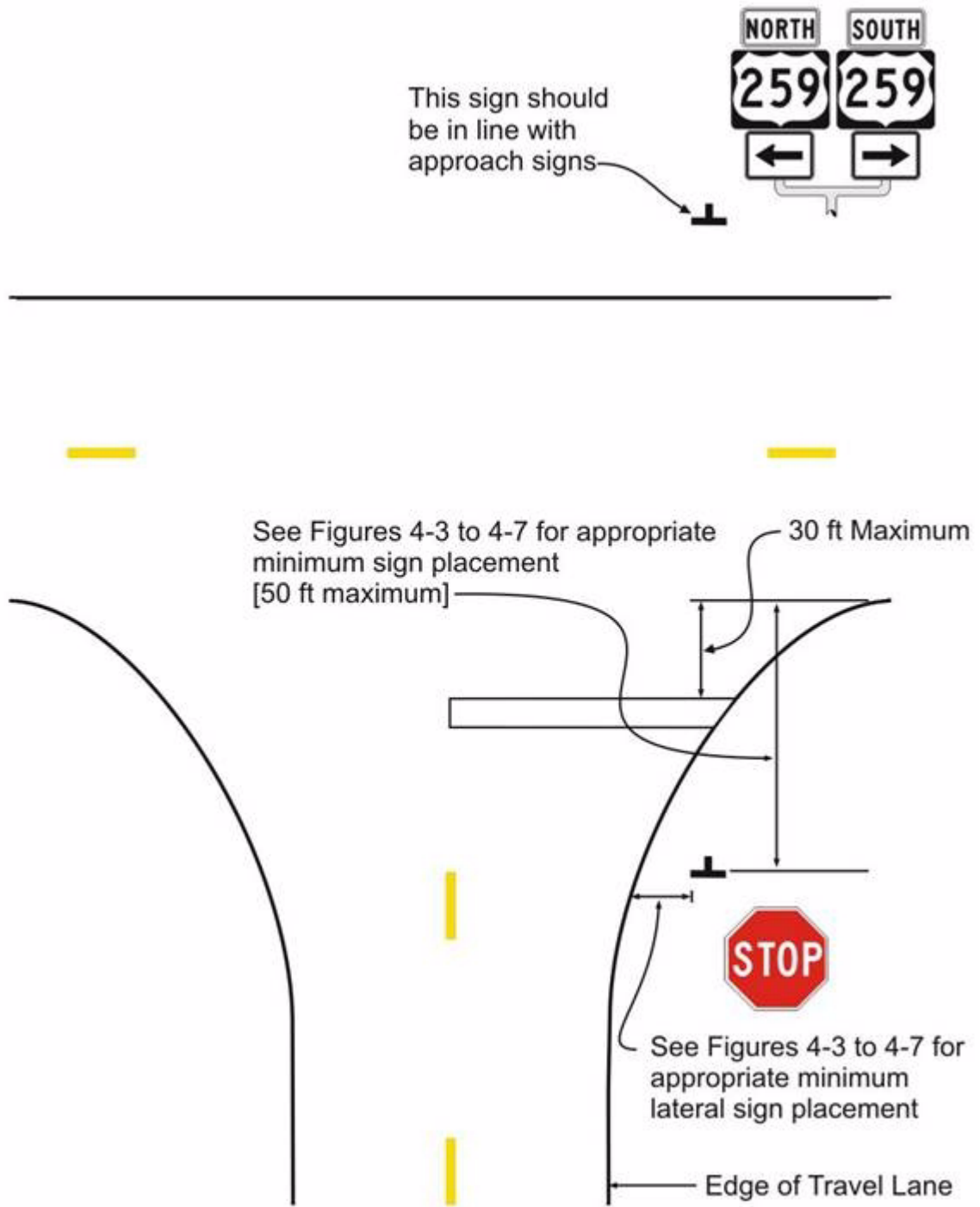

Figure 4-11. Stop/Yield Sign Lateral Placement at an Intersection with Divisional Island



Cross-Reference: Texas MUTCD Section 2B.06 and 2B.10, Figure 2A-2

Figure 4-12. Stop/Yield Sign Lateral Placement at a Wide-Throat Intersection

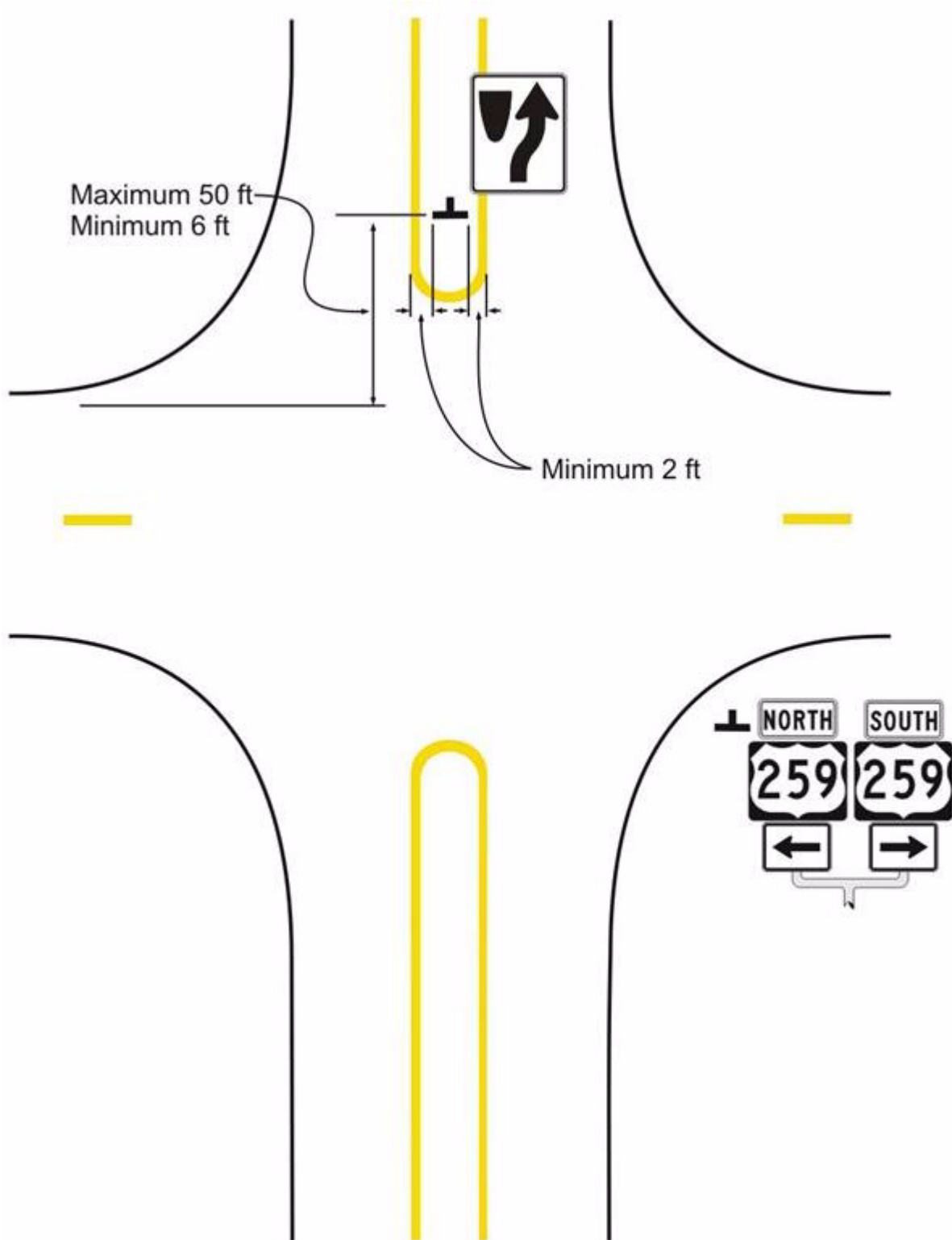

Figure 4-13. Keep Right Sign Lateral Placement on a Divisional Island



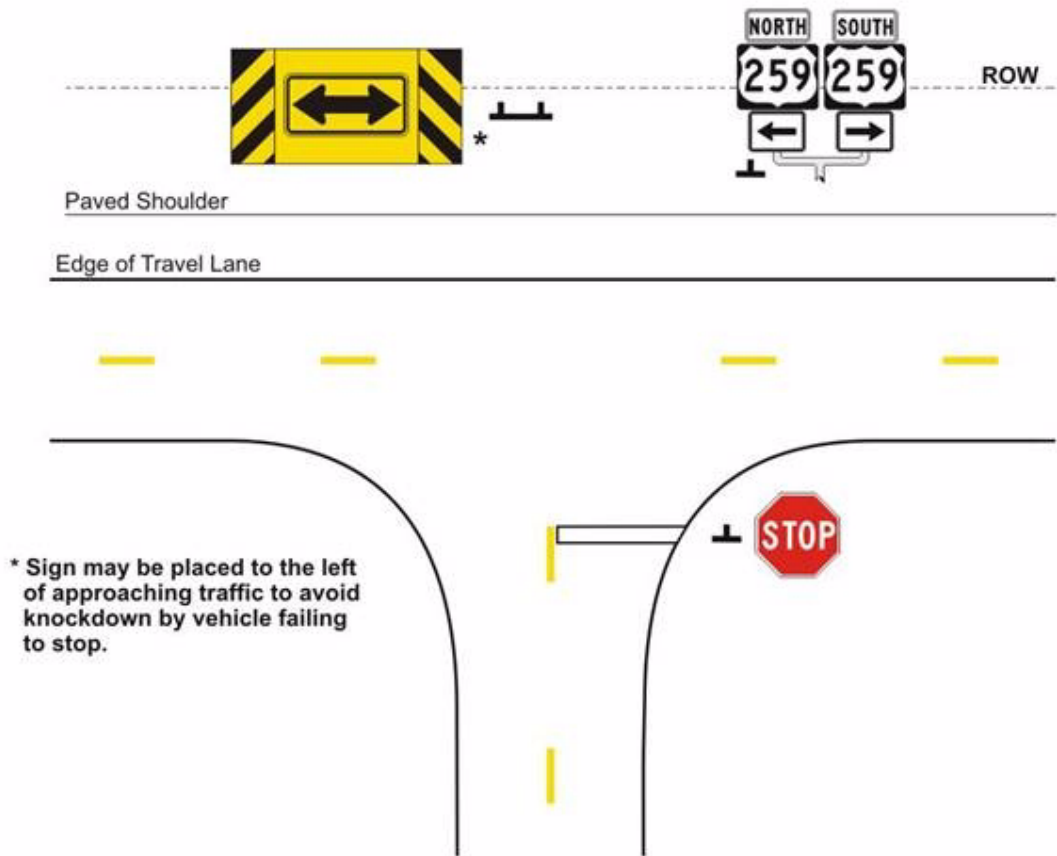
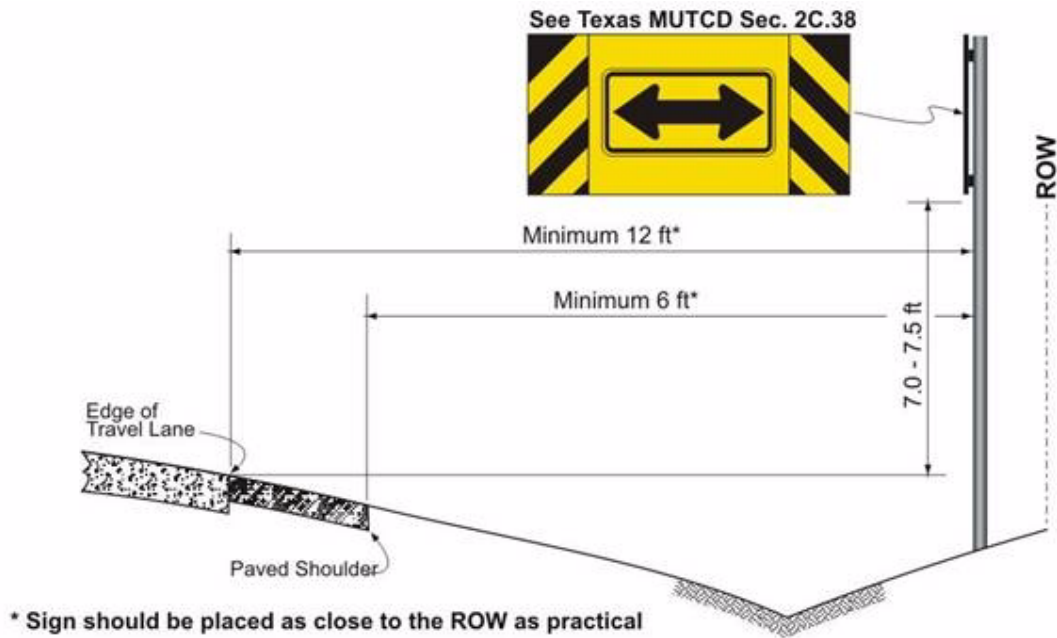

Figure 4-14. Placement of Large Arrow Panel

## Section 4

### Sign Height

#### Introduction

The proper sign height:

- ◆ Improves the visibility of the sign, and
- ◆ Provides appropriate safety performance.

Signs that are too low may not be visible to road users, particularly in heavy traffic. Likewise, signs that are too low may intrude into the vehicle compartment when struck.

#### Height of Signs and Sign Assemblies

Figures 4-15 through 4-21 on the following pages illustrate typical sign height situations. Section 2A.18 and Figure 2A-1 of the 2006 Texas MUTCD describe the height placement requirements for signs.

When the base of the sign post is below the edge of the travel lane, the sign height is measured from the edge of the travel lane to the bottom of the sign.

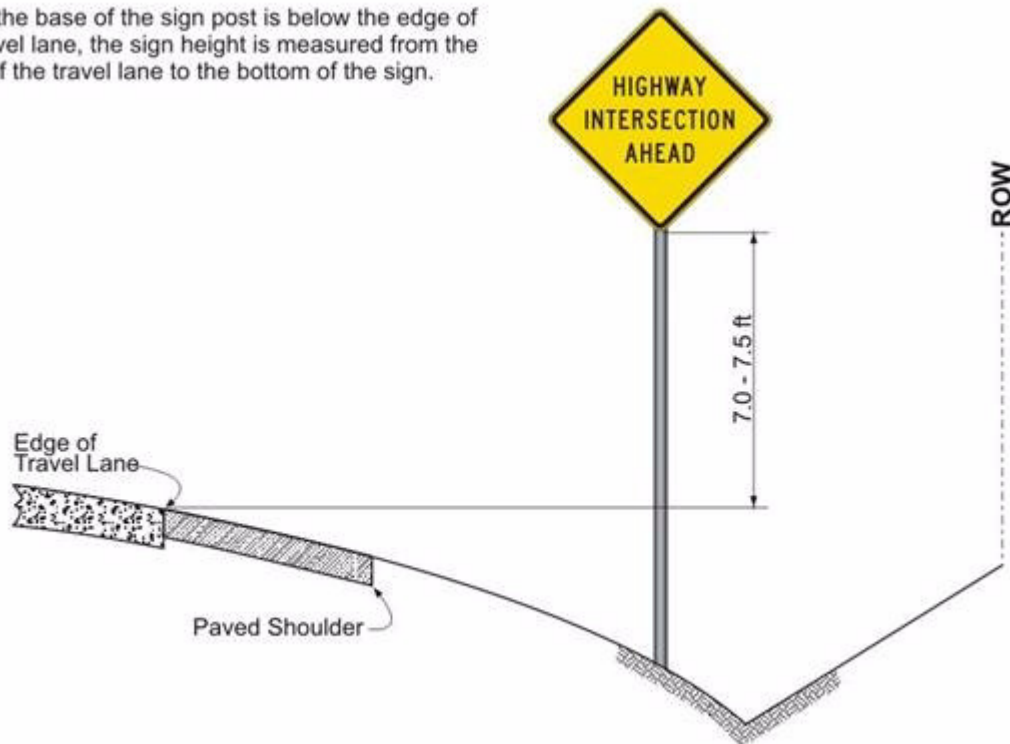

Figure 4-15. Sign Height on Front Slope

When the base of the sign post is above the edge of the travel lane, the sign height is measured from natural ground to the bottom of the sign.

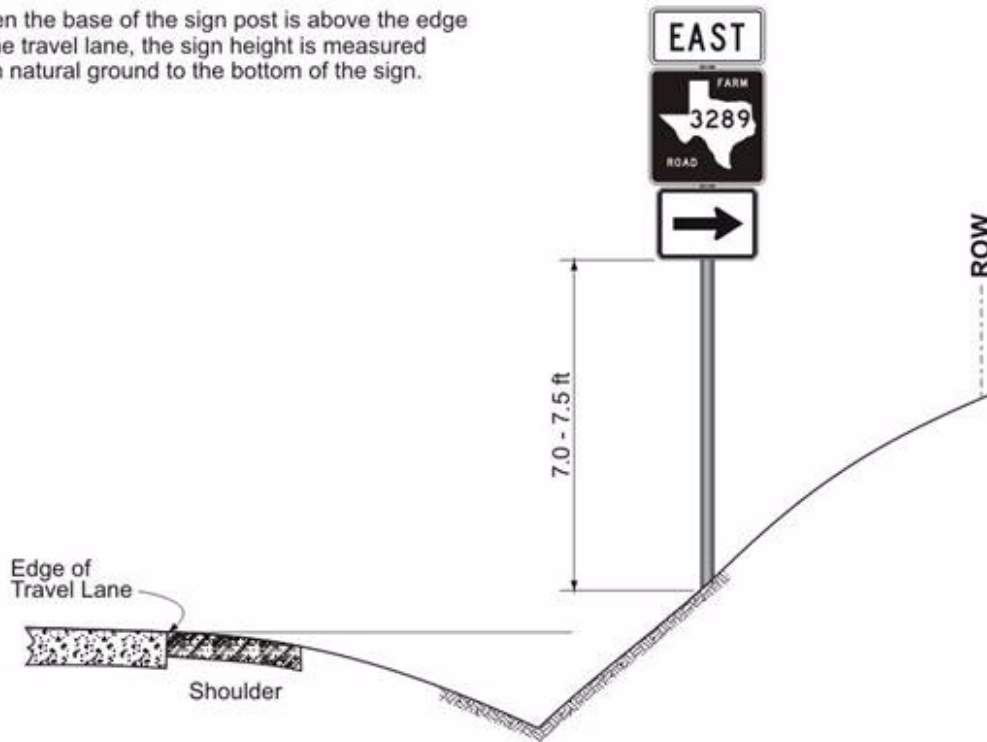
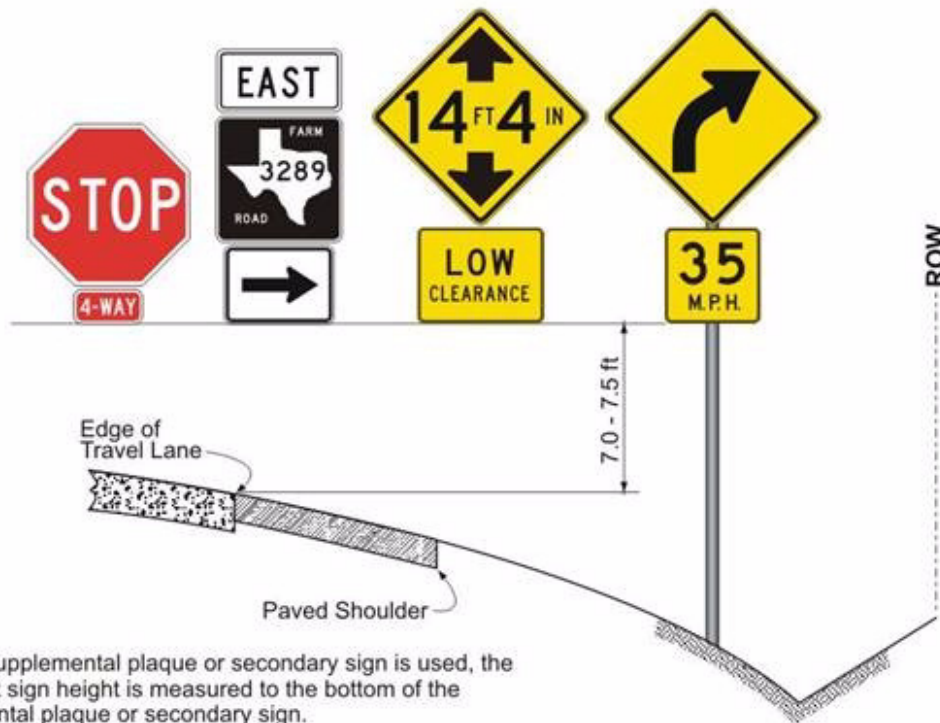

Figure 4-16. Sign Height on Back Slope



When a supplemental plaque or secondary sign is used, the 7.0 - 7.5 ft sign height is measured to the bottom of the supplemental plaque or secondary sign.

Figure 4-17. Sign Height for Installations with a Supplemental Plaque or Secondary Sign

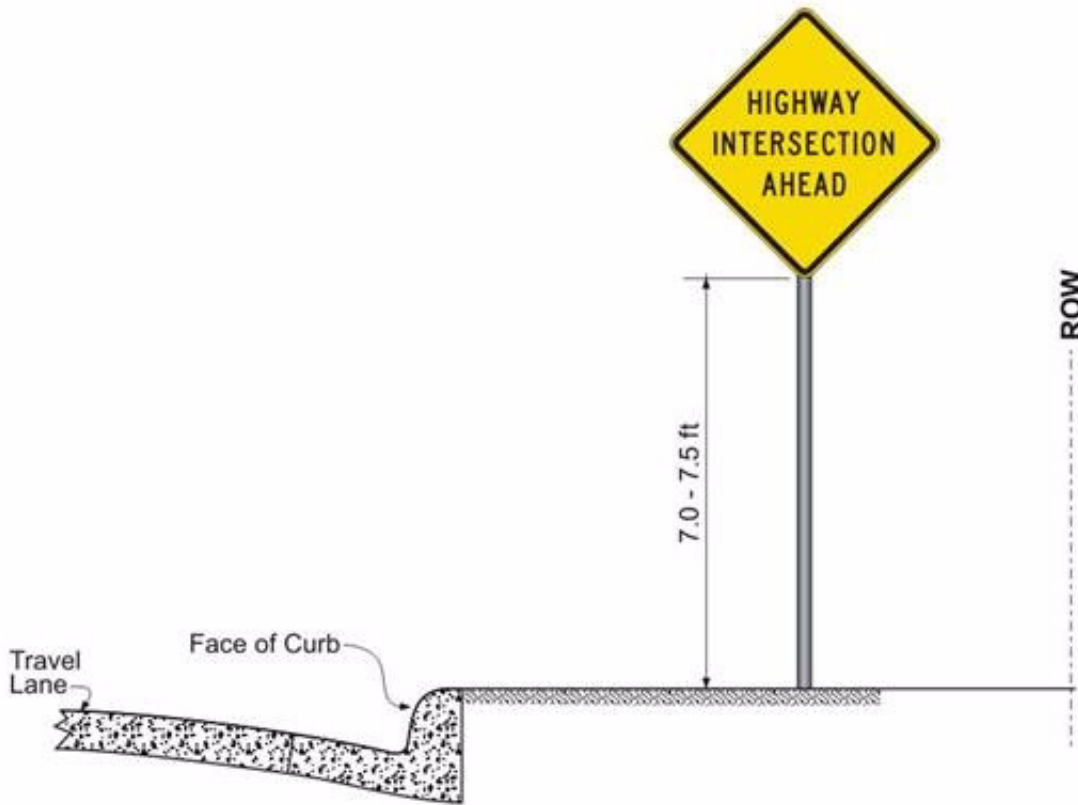

Figure 4-18. Sign Height on Curb and Gutter or Raised Island

When a sign has two or more posts, all posts must be at least 7.0 - 7.5 ft from natural ground to the bottom of the sign. The bottom of the sign must be at least 7.0 - 7.5 ft above the edge of the travel lane. If both minimum sign height distances cannot be achieved, an engineer should be consulted for guidance on the sign placement.

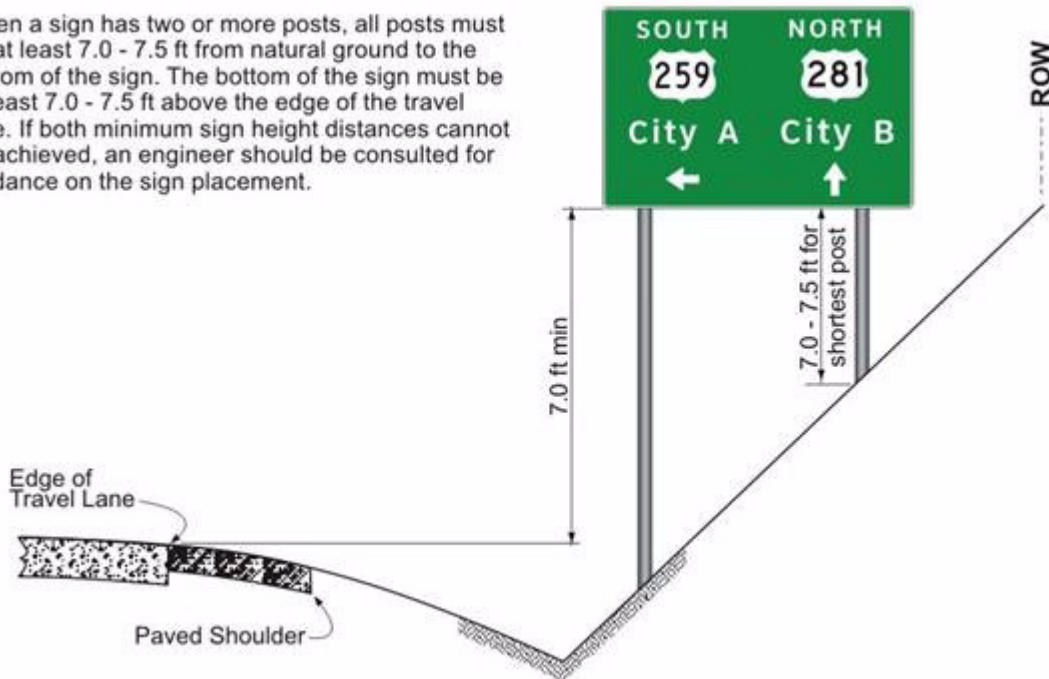
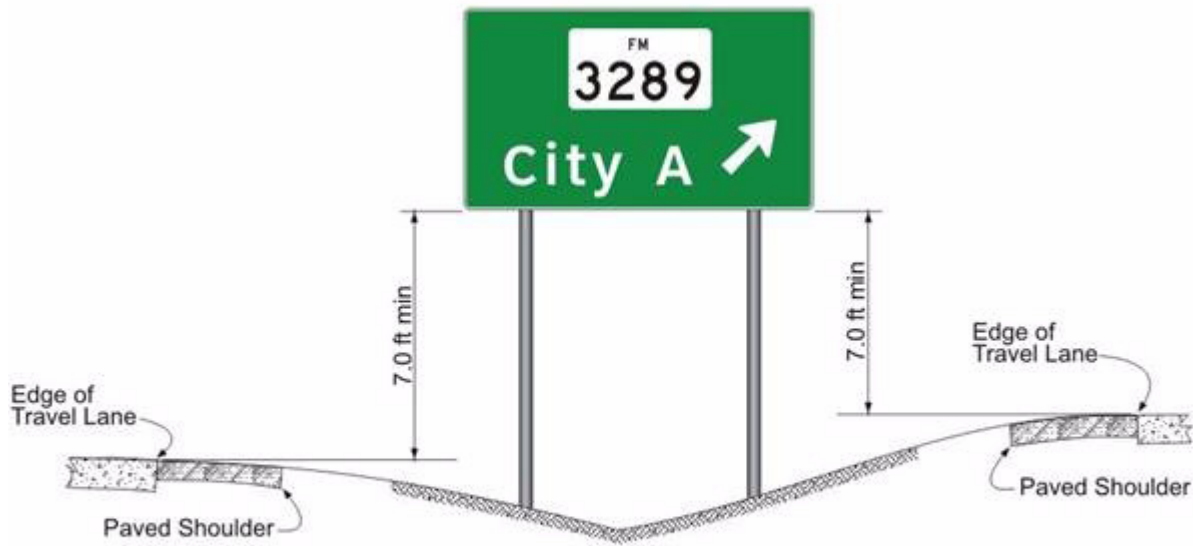

Figure 4-19. Sign Height for Large Sign with Two or More Posts



The sign in this figure is intended for traffic on the highway to the left of the sign.

Figure 4-20. Sign Height between Main Lanes and Frontage Road

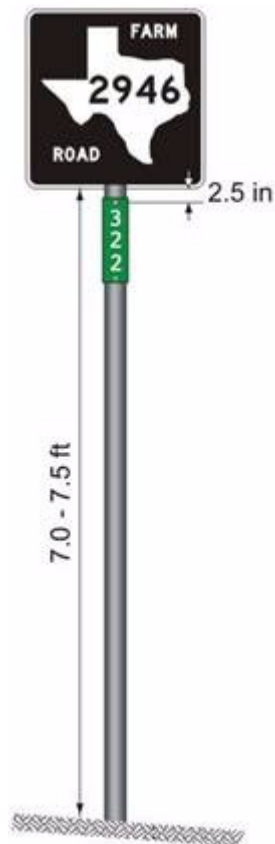

Figure 4-21. Height for Texas Reference Marker Assembly

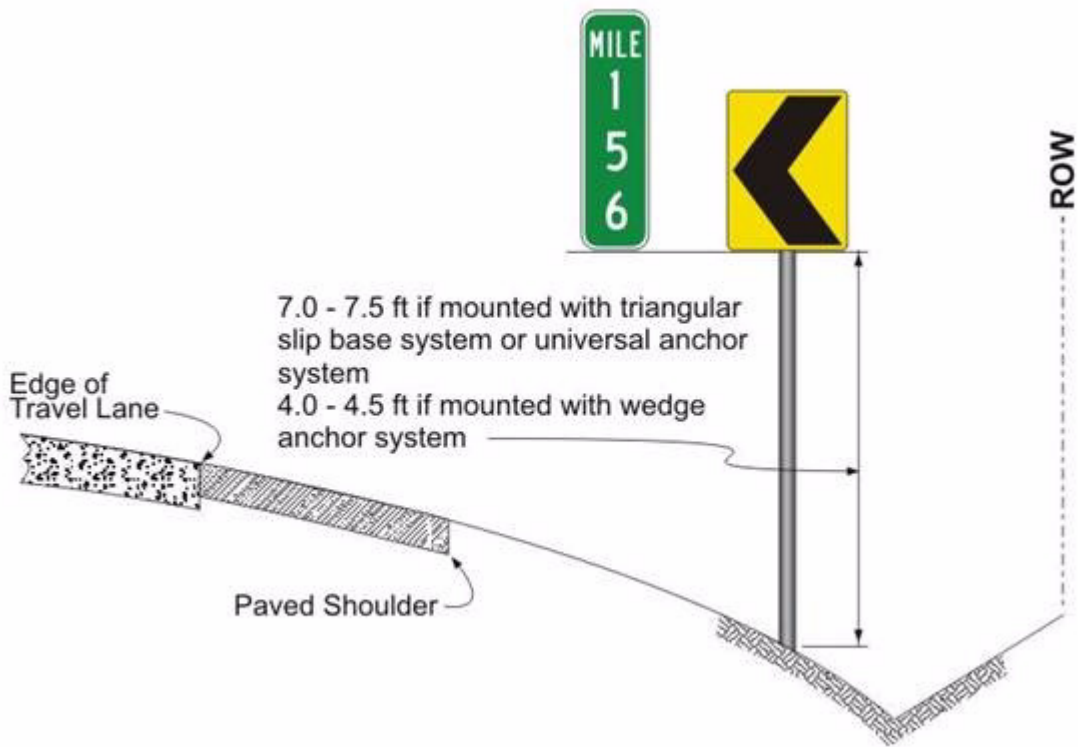

Figure 4-22. Height for Reference Location Signs and Chevron Signs

# Chapter 5

## Approach Placement

### Contents:

[Section 1 — Overview](#)

[Section 2 — Basic Placement Considerations](#)

[Section 3 — 3-Leg T Intersection Illustrations](#)

[Section 4 — 3-Leg Side Intersection Illustrations](#)

[Section 5 — 4-Leg Intersection Illustrations](#)

---

## Section 1

### Overview

#### Introduction

The longitudinal placement of guide signs on the approach to an intersection determines the amount of time available to the road user to make navigational decisions.

This chapter contains numerous drawings that illustrate the longitudinal placement of signs on the approach to an intersection. The illustrations are organized to address several different features that may be present at an intersection, including:

- ◆ Geometrics
  - 3-leg T
  - 3-leg side
  - 4-leg
- ◆ Number of approach lanes
  - 1 approach lane
  - 1 approach lane with left-turn lane
  - 2 approach lanes
  - 2 approach lanes with left-turn lane
- ◆ Type of intersection control
  - No control
  - Stop control
  - Signal control
- ◆ Routing arrangement of intersecting highways
  - Approach route(s) goes left, through, and/or right
  - 1, 2, or 3 intersecting highways

The placement of signs on the departure from the intersection is addressed in Chapter 6.

A figure index table has been developed for the figures contained within this chapter. This figure index table will assist in quickly locating a figure based on the basic information available such as intersection geometry, number of approach lanes, and type of traffic control used at the intersection.

The Figure Index Table is located on page 5-9.



## Section 2

### Basic Placement Considerations

#### Introduction

The figures in this chapter indicate the placement of signs located on the approach to an intersection.

- ◆ **Special Note on Approach Placement Distances:** A given sign type should remain approximately the same distance from the intersection in all applications. For example, the Junction assembly should always be 1625-1800 ft from the intersection when the speed limit is  $\geq 45$  mph. A given type of sign should not be moved closer to the intersection when a sign type closer to the intersection is not used. For example, the Junction assembly should not be moved closer to the intersection if the Advance Route Turn assembly is not used.

## Convention Used in Illustrations

The illustrations contained in this chapter utilize several conventions to simplify the information being presented in the figures.

- ◆ **Use of Highway Classifications and Numbers in Illustrations** - The highway intersections illustrated in this field book are not intended to represent specific intersections in the state. For simplicity, only one highway class is used for all highways in the illustrations, and no more than six different route numbers are used. The six highway numbers used in the illustrations are three-digit U.S. Highway numbers: U.S. 180, U.S. 259, U.S. 290, U.S. 281, U.S. 377, and U.S. 380.
- ◆ **Reference Points for Placement Distances** - The distance shown in the figures is the distance between the sign installation and the near edge of the intersecting roadway. Figures 5-2 and 5-3 illustrate the application of this convention and Table 5-1 contains the placement distances for each type of sign that could be used on an approach to an intersection.
- ◆ **Cross-References to the Texas MUTCD** - Where it is appropriate, notes in the figures refer to material in the Texas MUTCD related to the use of a specific sign. These cross-references are typically provided to help the user determine whether a sign should be used in a particular situation.
- ◆ **Figure Symbol Boxes Description** - Each of the figures shown in Sections 3, 4, and 5 has a symbol box located in the lower right-hand corner of the figure. The purpose of these boxes is to assist in quickly determining what is illustrated in a particular figure. These symbol boxes represent the intersection geometrics, routing arrangement, and type of traffic control devices used in the intersection. Each of these symbol boxes has two basic sections. The left most section contains the type of traffic control device used at the intersection, such as a Stop sign, a traffic signal, or no control. The right most section contains the sketch of the intersection geometry and routing arrangement for the intersection. The arrows in the right section of the box represent the intersection routing arrangement. They show the direction the assigned routes are going or in some cases ending. For example, the symbol box in Figure 5-1 illustrates the following: the left-hand section of the symbol box tells that a Stop sign is used as the traffic control device. Likewise, in the right-hand section of the symbol box a 3-leg intersection is shown having a routing arrangement that consists of the approach route going right.

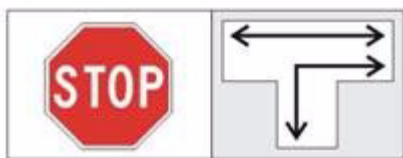

Figure 5-1. Example of Symbol Box

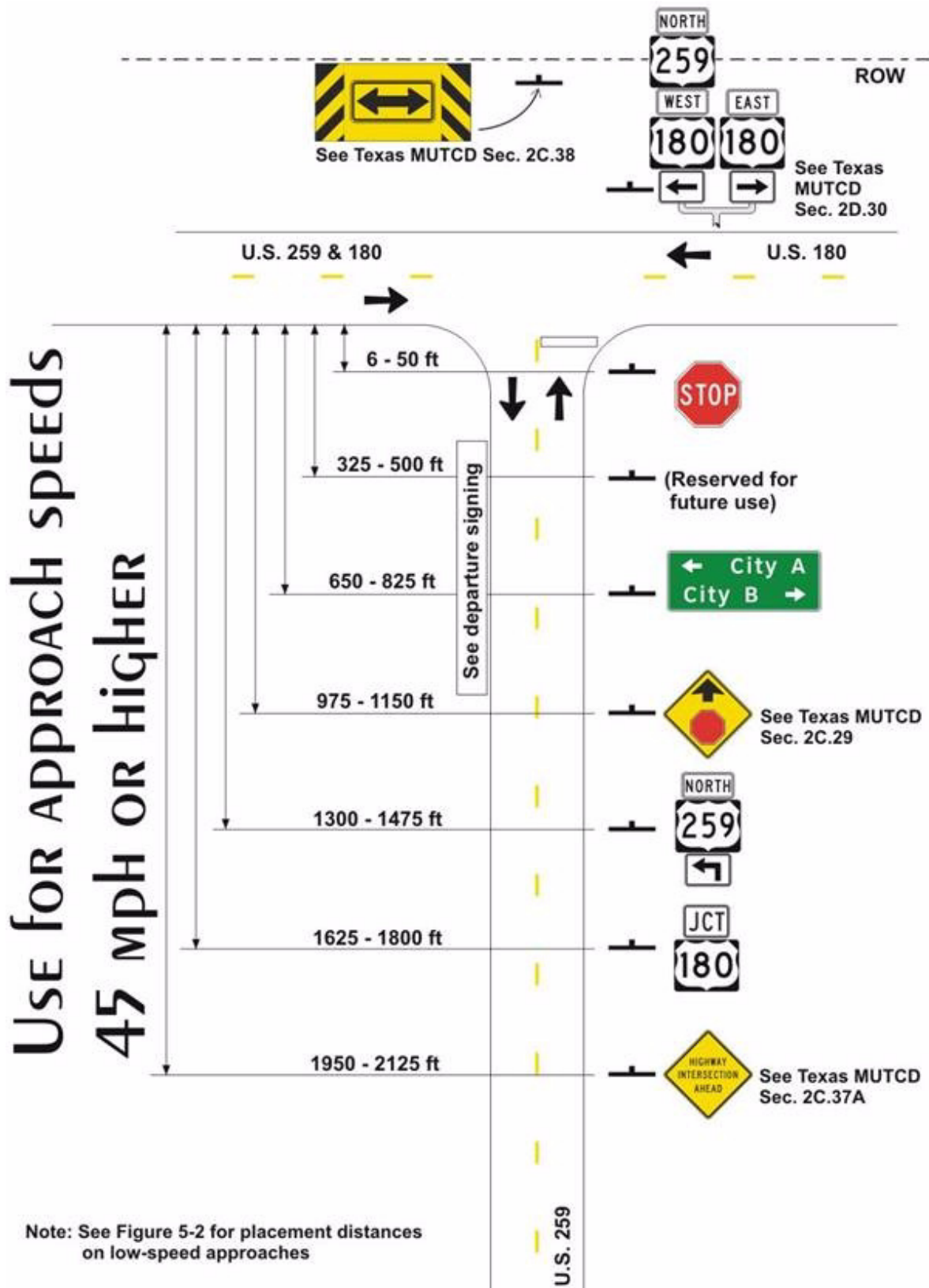

Figure 5-2. Convention for Sign Placement Distances on High Speed Approach

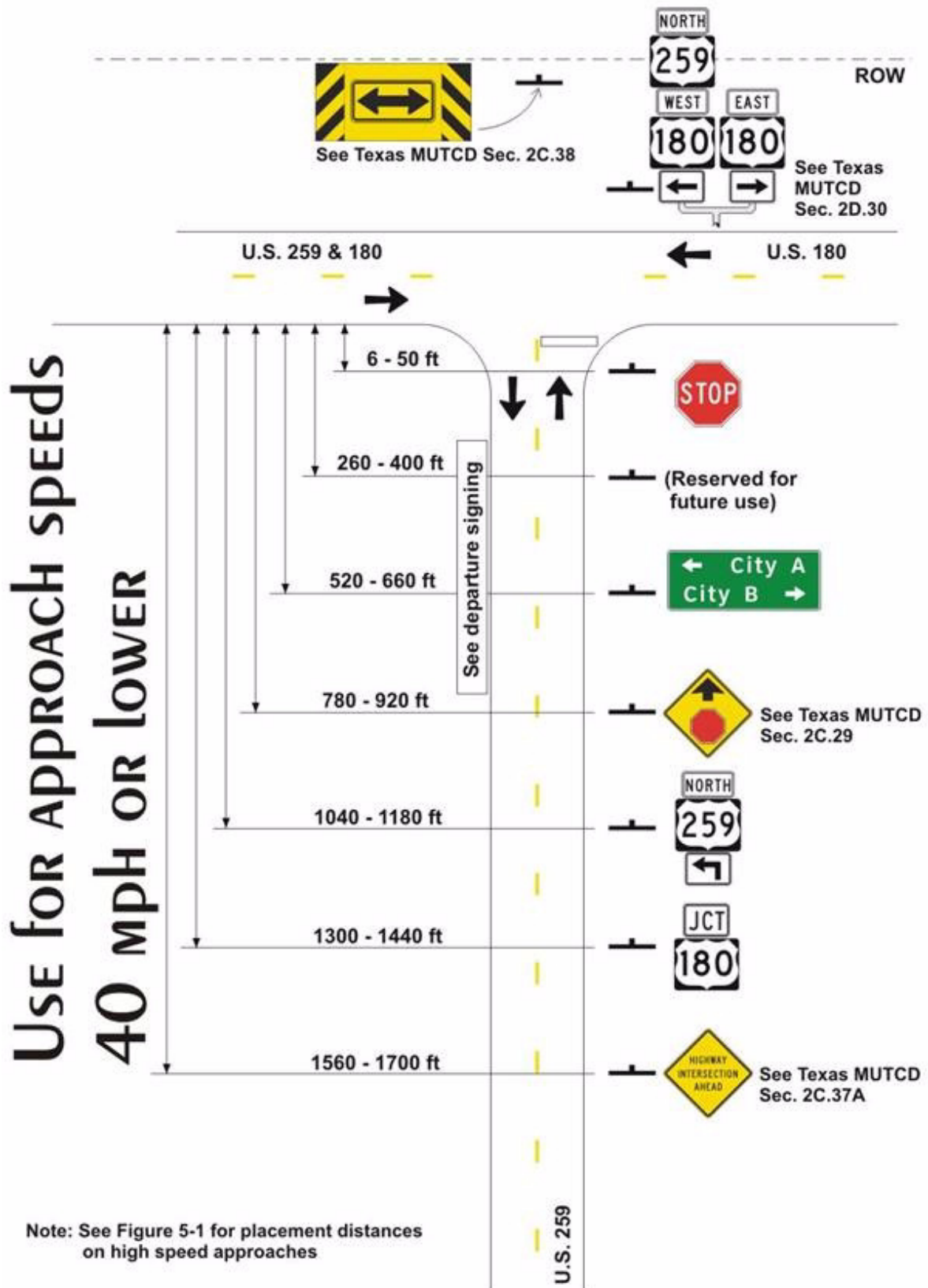

Figure 5-3. Convention for Sign Placement Distances on Low Speed Approach

## Effect of Speed on Placement Distances

The posted speed is the primary criteria for the longitudinal placement of signs. Speed is divided into low-speed roadways (speed  $\leq$  40 mph) and high-speed roadways (speed  $\geq$  45 mph)

The distances shown in the figures in this chapter are for highways with speeds of 45 mph or greater. For highways with speeds of 40 mph or less, signs may be placed closer to the intersection. Table 5-1 identifies the high-speed and low-speed placement distances for each type of sign that could be used on an approach to an intersection.

**Table 5-1: Approach Placement Distances**

Placement Distance for Speed Condition <sup>1</sup> (Distance from near edge of intersecting roadway)		Type of Sign
Low-Speed ( $\leq$ 40 mph), ft <sup>2</sup>	High-Speed ( $\geq$ 45 mph) ft <sup>3</sup>	
6-50	6-50	Directional Assembly or Stop Sign
260-400	325-500	Reserved for Future Use
520-660	650-825	Destination Sign
780-920	975-1150	Advance Traffic Control Sign
1040-1180	1300-1475	Advance Route Turn Assembly
1300-1440	1625-1800	Junction Assembly
1560-1700	1950-2125	Highway Intersection Sign
Notes: <sup>1</sup> A sign installation should not be moved closer to the intersection if another sign is not used. In other words, the Junction assembly should always be 1625-1800 ft from the intersection, even if the Advance Route Turn assembly is not installed. <sup>2</sup> Generally rounded to the nearest 10 ft. <sup>3</sup> Generally rounded to the nearest 25 ft.		

---

## Approach Placement Illustrations

The illustrations in this chapter illustrate typical sign placements for various intersection designs. The intersections present the following types of information:

- ◆ Geometry
  - 3-leg T (Chapter 5, Section 3)
  - 3-leg side (Chapter 5, Section 4)
  - 4-leg (Chapter 5, Section 5)
- ◆ Number of Approach Lanes
  - 1 approach lane alone
  - 1 approach lane with left-turn lane
  - 2 approach lanes alone
  - 2 approach lanes with left-turn lane
- ◆ Type of Control
  - No control on approach
  - Stop or Yield control on approach
  - Signal control on approach
- ◆ Highway Routing Arrangement
  - Numbered highway ends at intersection
  - Numbered highway turns right or left at intersection
  - Highway continues through intersection
  - Any two or more of the above arrangements

Table 5-2 is an index that indicates how the approach characteristics shown above are incorporated into the figures in this chapter.

**Table 5-2: Index to Approach Placement Illustrations**

Fig. No.	Geometry			Number of Approach Lanes				Type of Control			Routing Arrangement				
	3-leg T	3-leg Side	4-leg	1 Ln.	1 Ln. + LT	2 Ln.	2 Ln. + LT	None	Stop	Signal	Ends	Left	Thru	Right	Other
5-4	√			√					√			√			
5-5	√			√					√			√			
5-6	√			√					√		√				
5-7	√			√						√				√	
5-8	√			√					√			√		√	
5-9	√					√				√				√	
5-10		√		√				√					√		
5-11		√		√				√				√	√		
5-12		√			√			√				√	√		
5-13		√				√		√				√	√		
5-14		√		√						√			√		√
5-15		√			√					√			√		√
5-16		√					√			√			√		√
5-17			√	√					√				√		
5-18			√	√				√					√		
5-19			√	√					√			√	√		
5-20			√	√						√			√		
5-21			√	√						√			√	√	
5-22			√	√						√		√	√		
5-23			√			√		√					√		
5-24			√		√					√			√		√
5-25			√	√					√		√				
5-26			√	√					√			√			
5-27			√	√					√			√		√	
5-28			√	√						√				√	
5-29			√	√						√		√		√	

## Section 3

### 3-Leg T Intersection Illustrations

#### **Introduction**

This section illustrates the signing placement for the approach to a 3-leg T intersection. The figures are drawn so that the signed approach is intersecting a main roadway. Each of the figures illustrates how different intersection characteristics affect the signing on the approach.



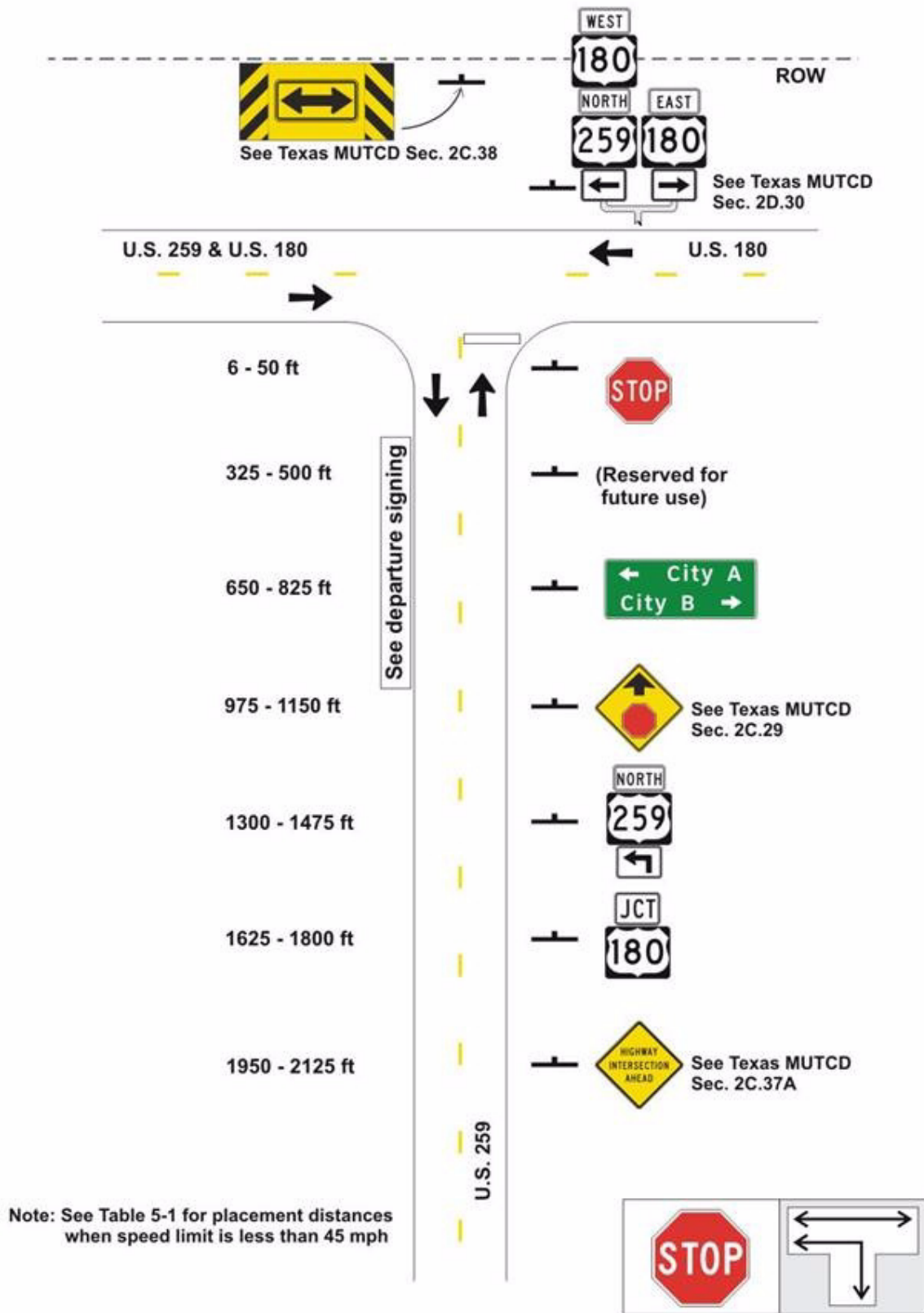

Figure 5-4. 3-Leg T, 1 Approach Lane, Stop Control, Approach Route Goes Left

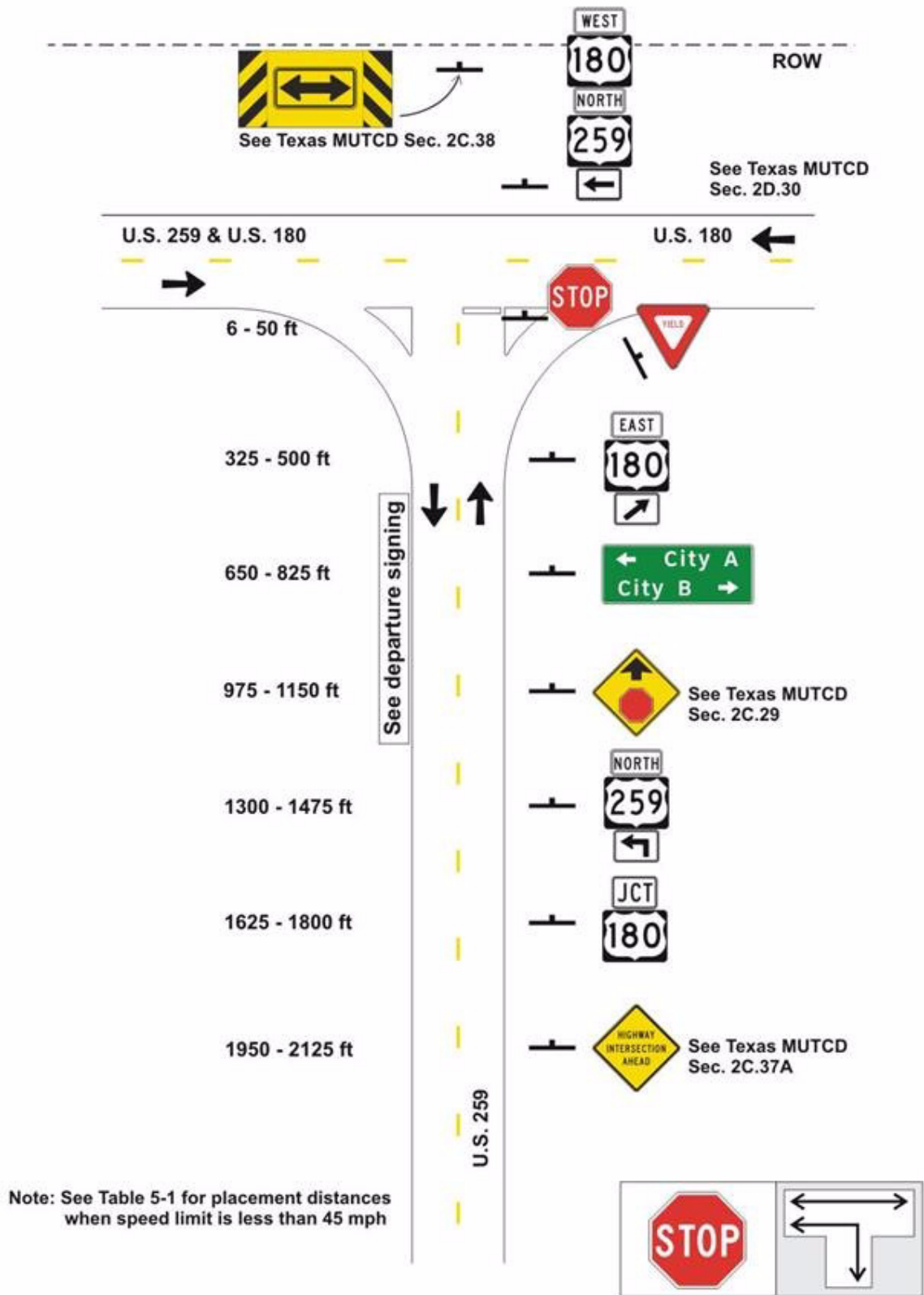

Figure 5-5. 3-Leg T, 1 Approach Lane with Free Right Turn, Stop Control, Approach Goes Left

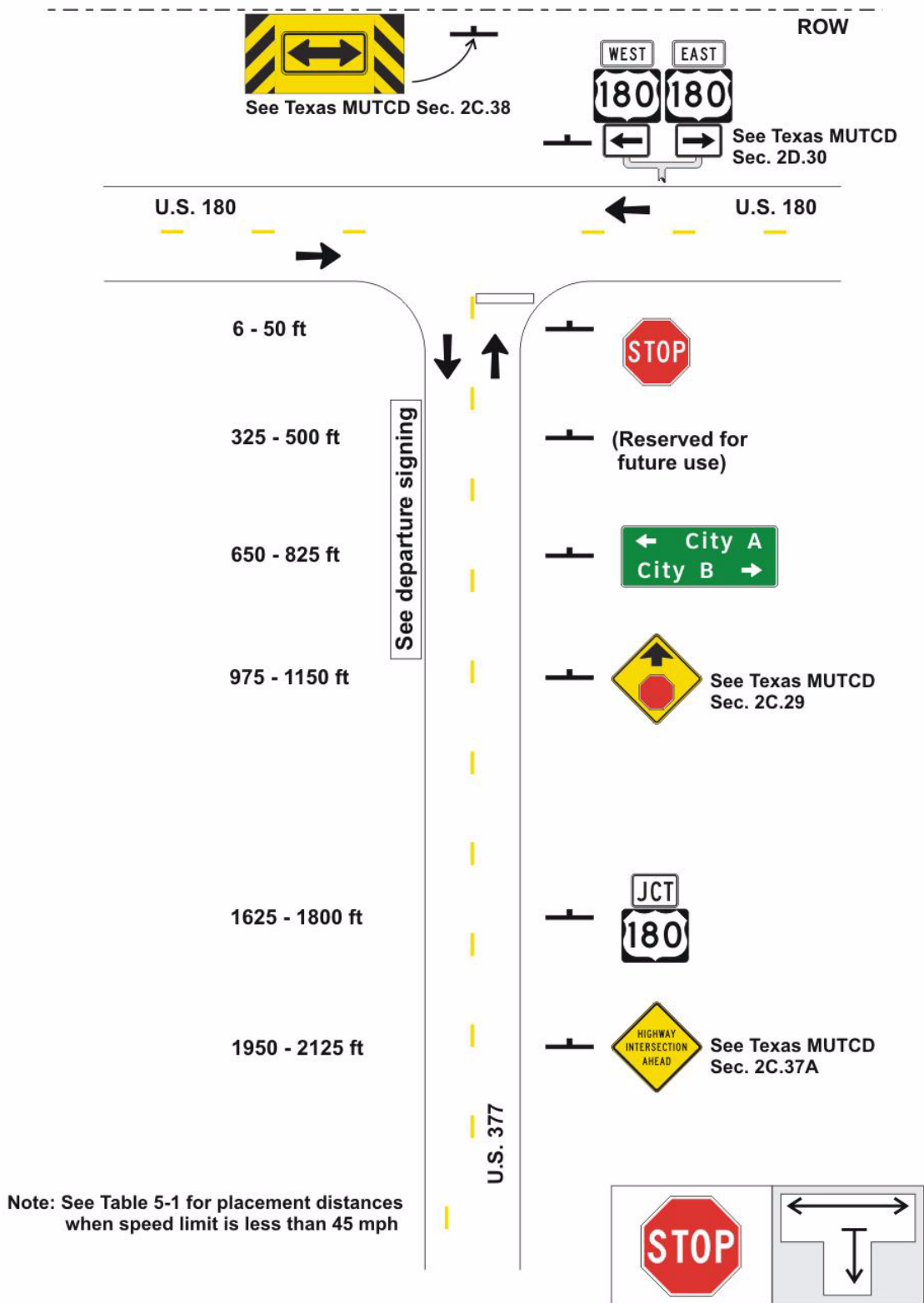

Figure 5-6. 3-Leg T, 1 Approach Lane, Stop Control, Approach Route Ends

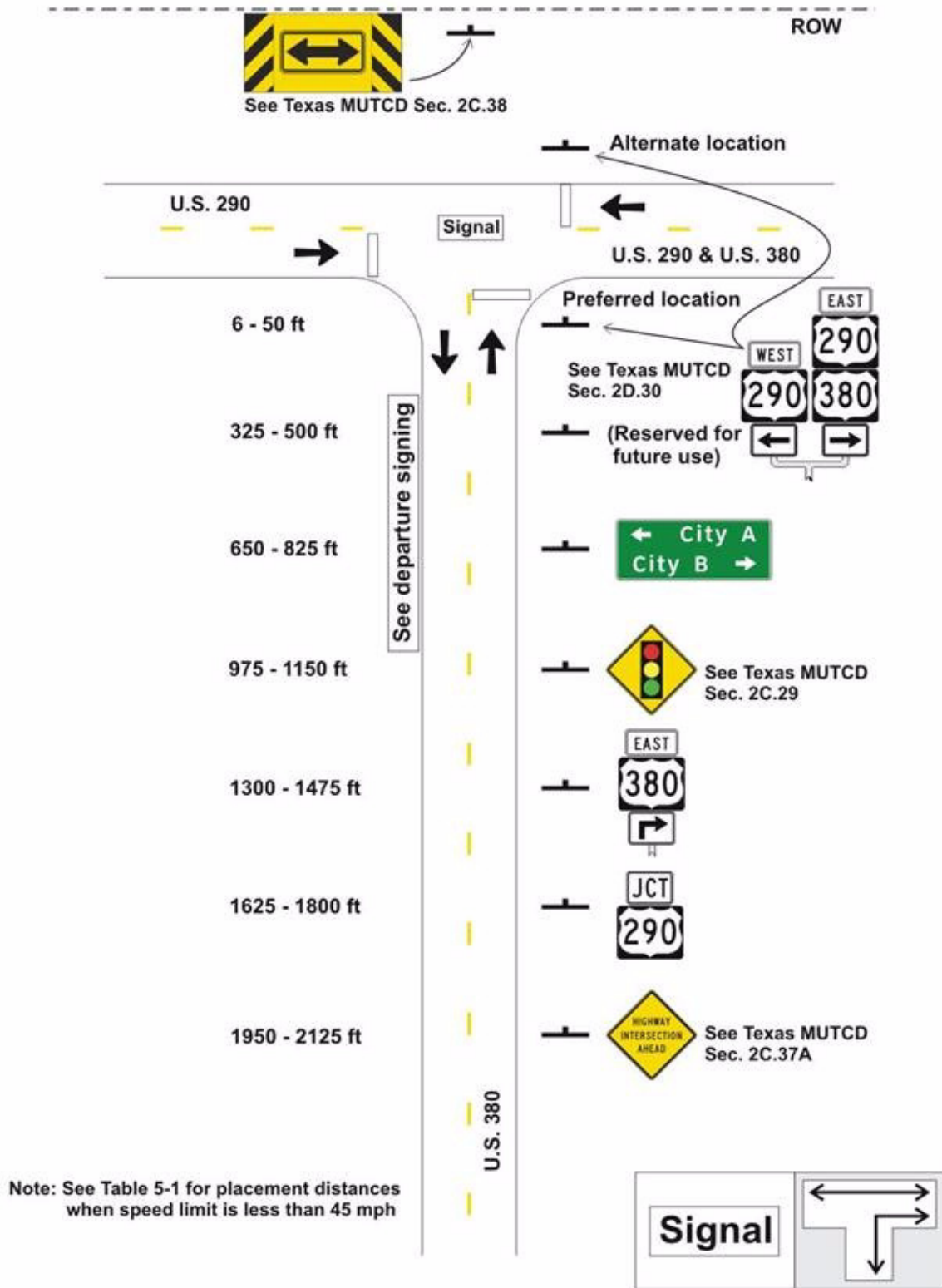

Figure 5-7. 3-Leg T, 1 Approach Lane, Signal Control, Approach Route Goes Right

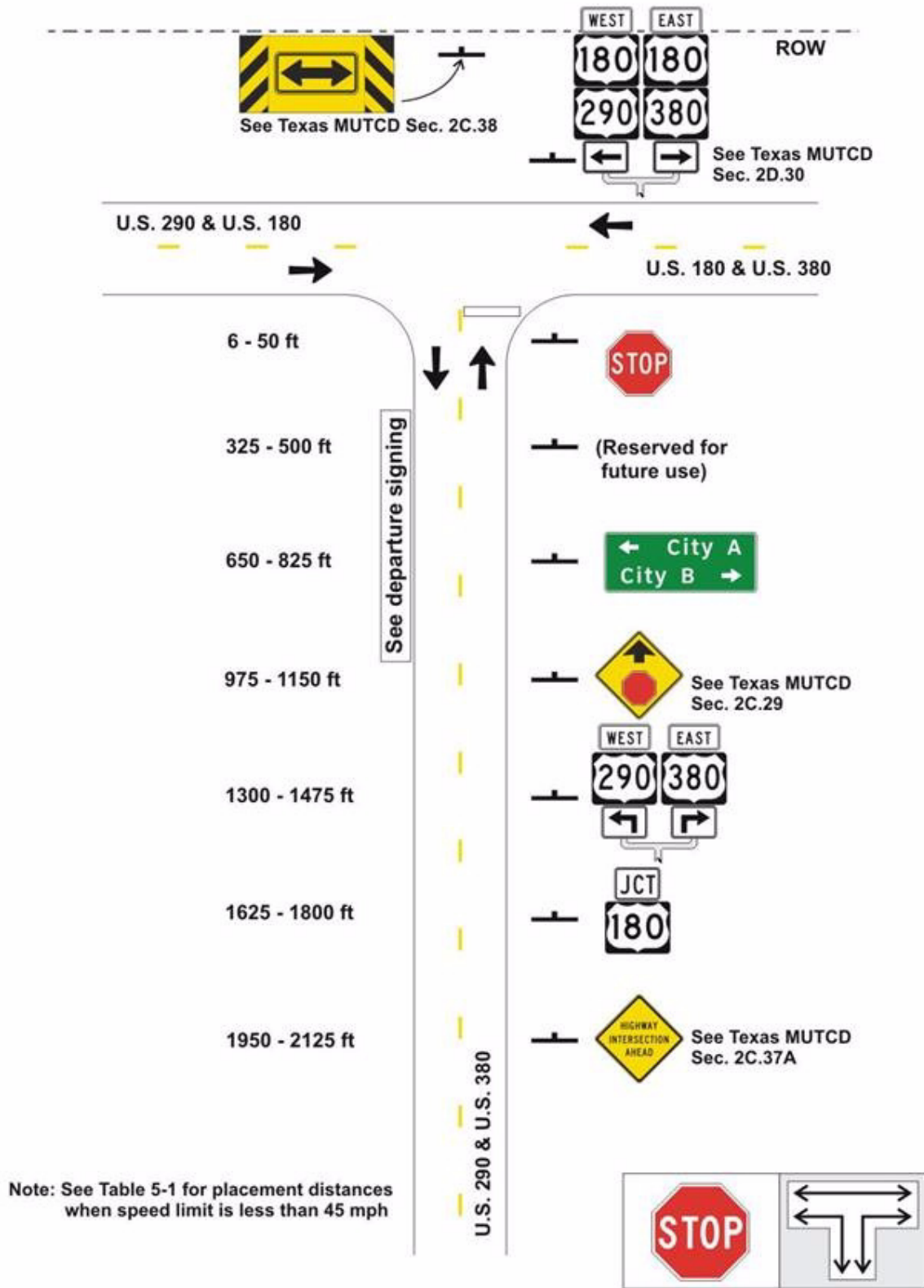

Figure 5-8. 3-Leg T, 1 Approach Lane, Stop Control, Approach Routes Go Left and Right

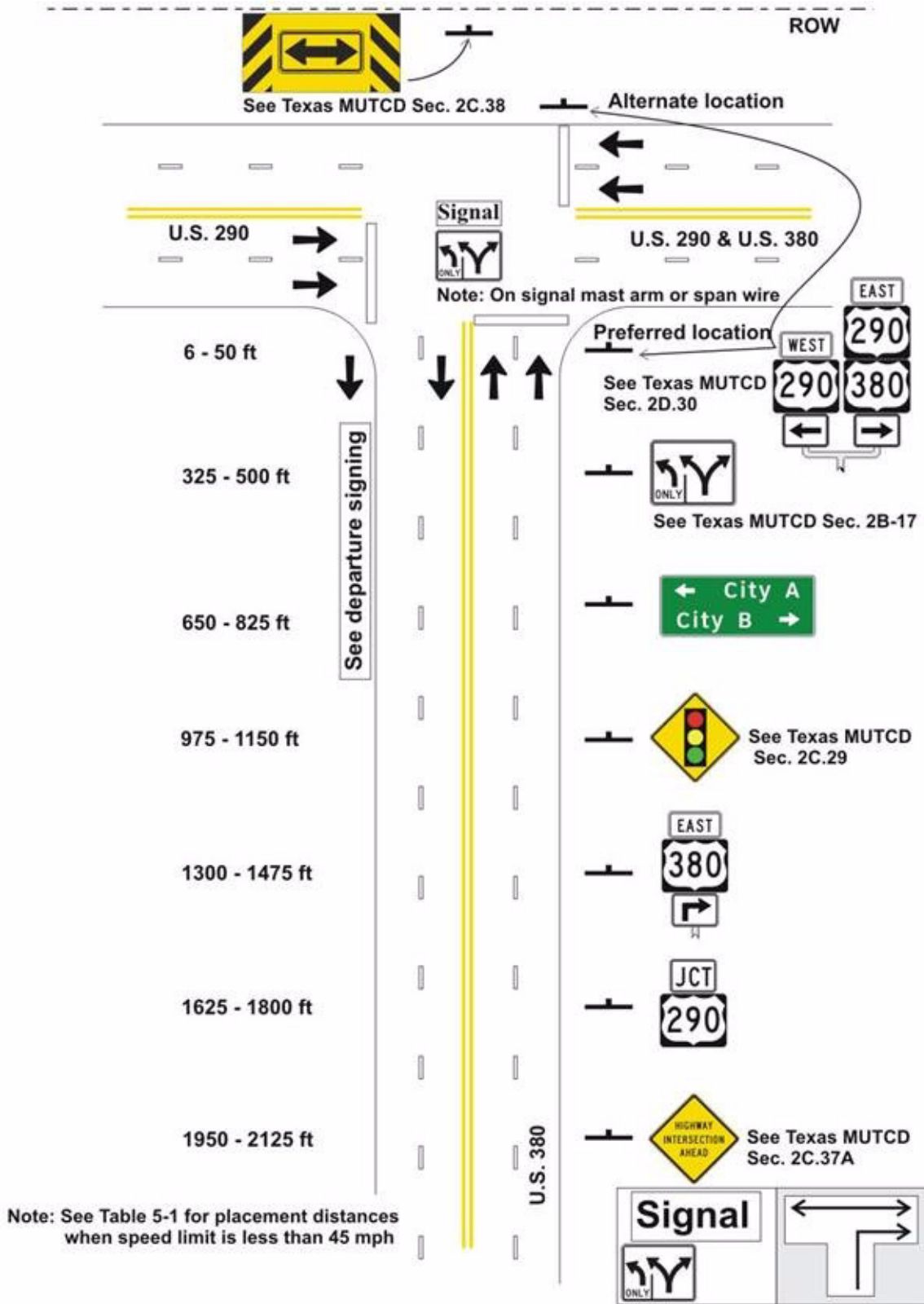

Figure 5-9. 3-Leg T, 2 Approach Lanes with Dual-Left, Signal Control, Approach Route Goes Right

## Section 4

### 3-Leg Side Intersection Illustrations

#### Introduction

This section illustrates the signing placement for the main roadway approach to a 3-leg side intersection. The figures are drawn so that the signed approach is intersecting a secondary roadway to the left of the approach. For signing of the approach where the intersecting roadway is on the right, the sign would be the same except the appropriate arrows would need to be used for correct directions, and some sign assemblies would need to be mirrored. Each of the figures illustrates how different intersection characteristics affect the signing on the approach.

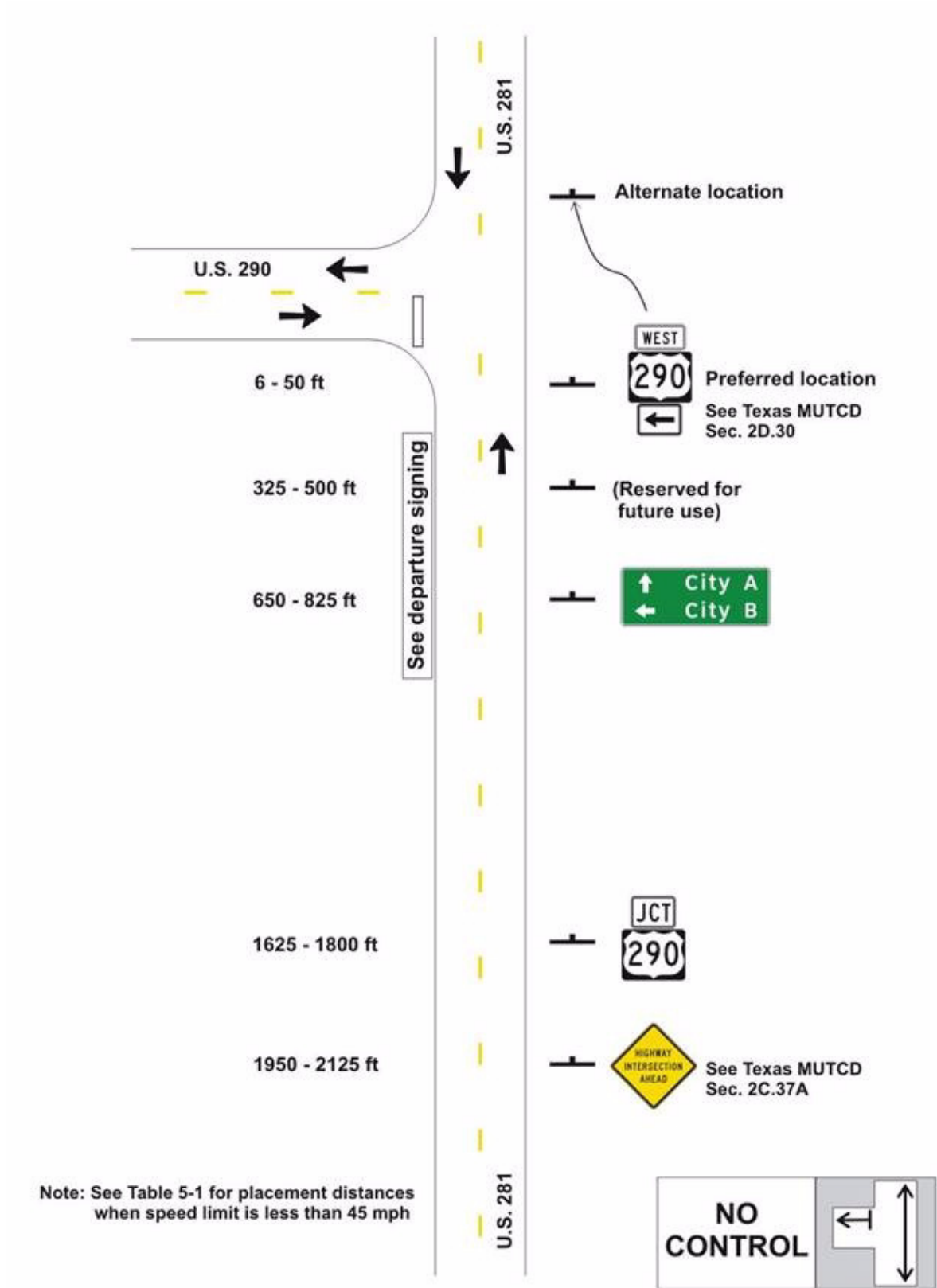

Figure 5-10. 3-Leg Side, 1 Approach Lane, No Control, Approach Routes Go Through



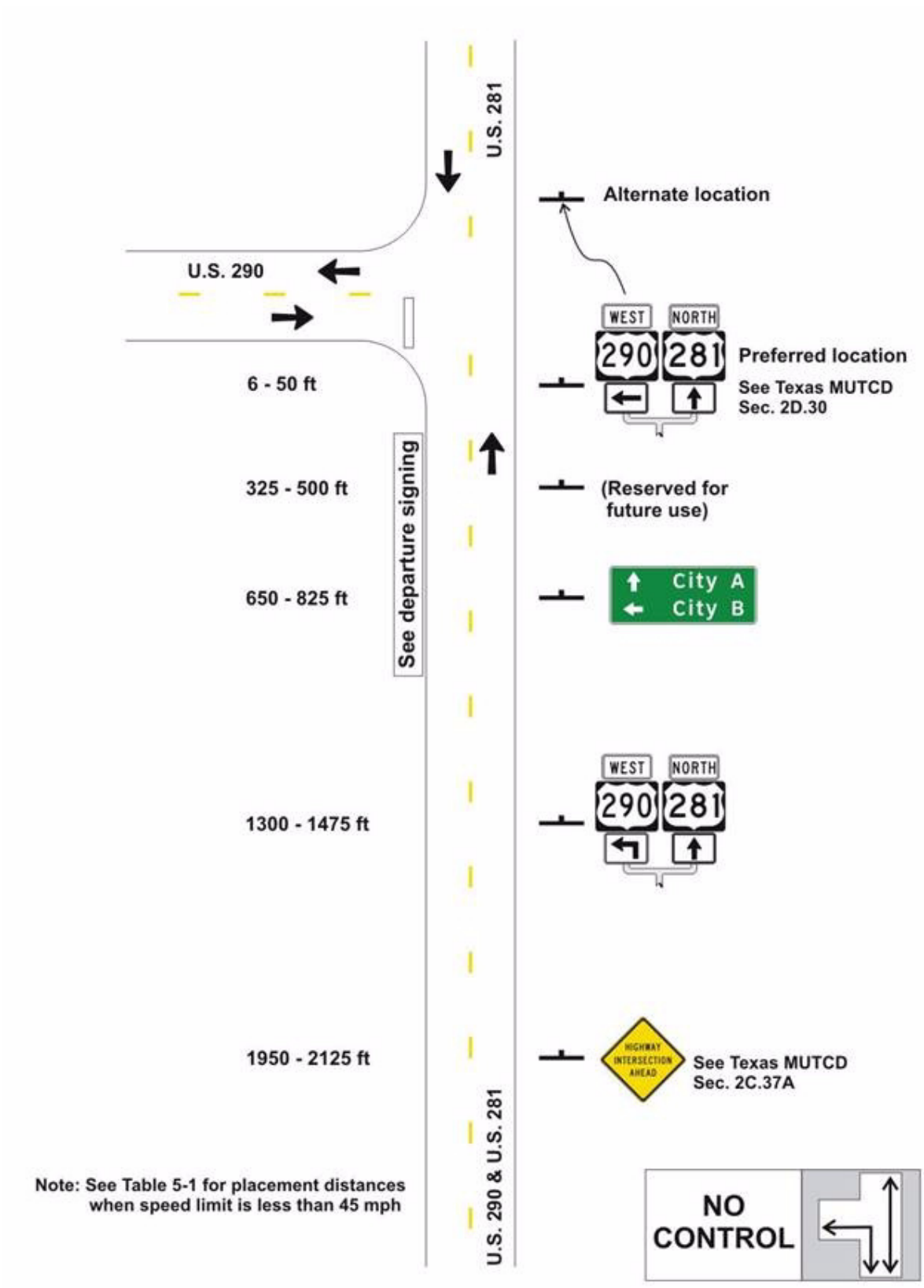

Figure 5-11. 3-Leg Side, 1 Approach Lane, No Control, Approach Routes Go Through & Left

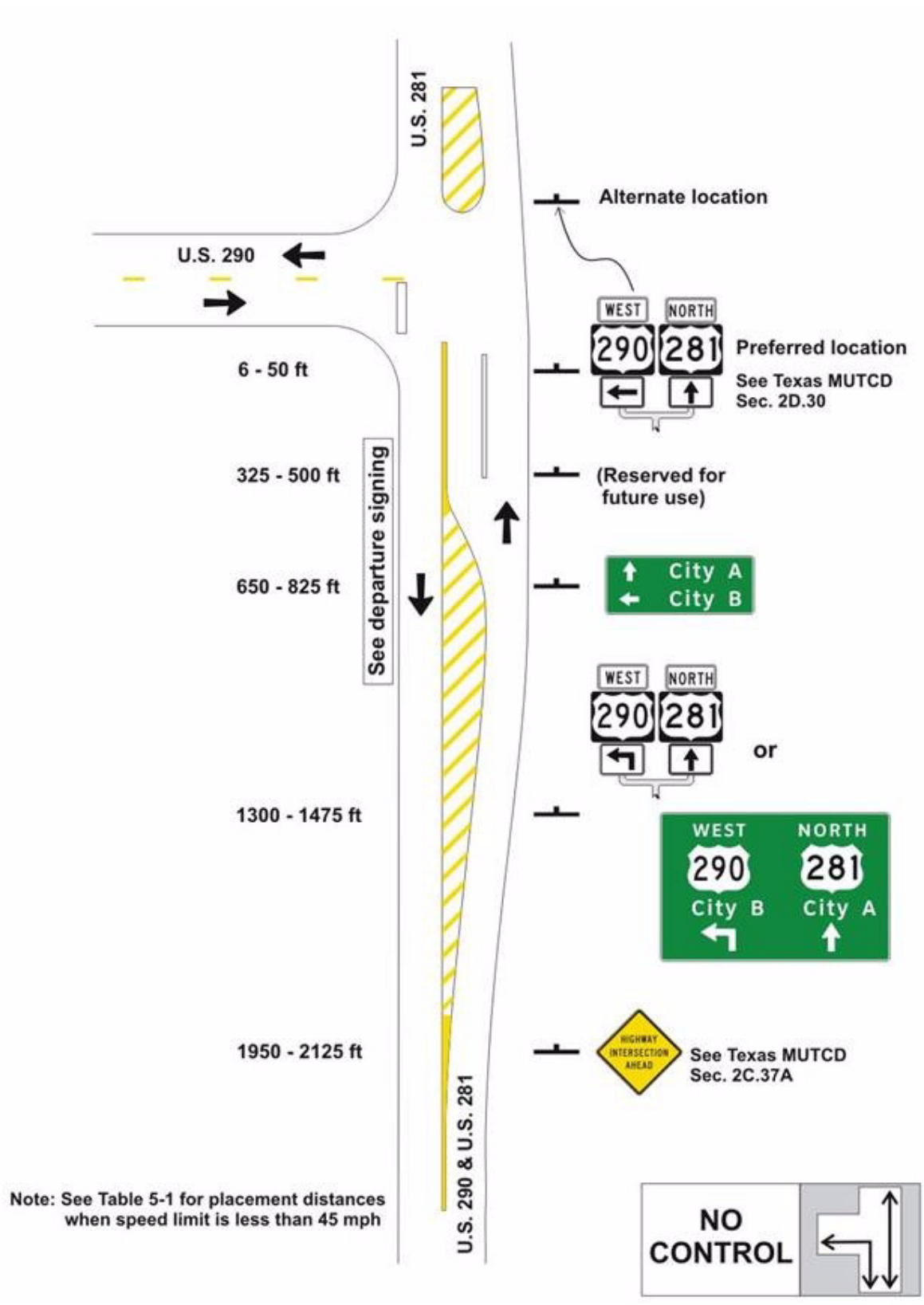

Figure 5-12. 3-Leg Side, 1 Approach + 1 LT, No Control, Approach Routes Go Through & Left

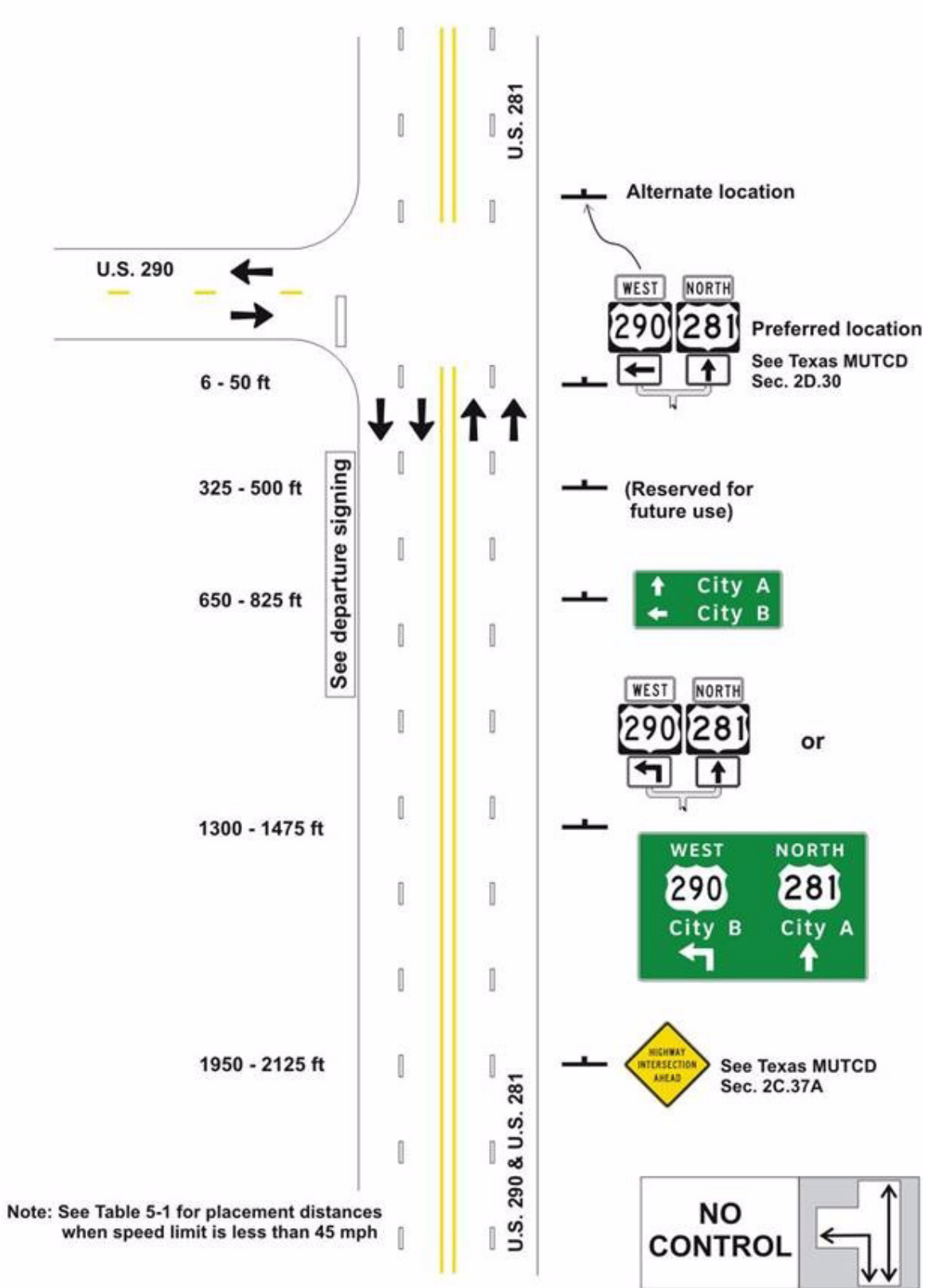

Figure 5-13. 3-Leg Side, 2 Approach Lanes, No Control, Approach Routes Go Through & Left

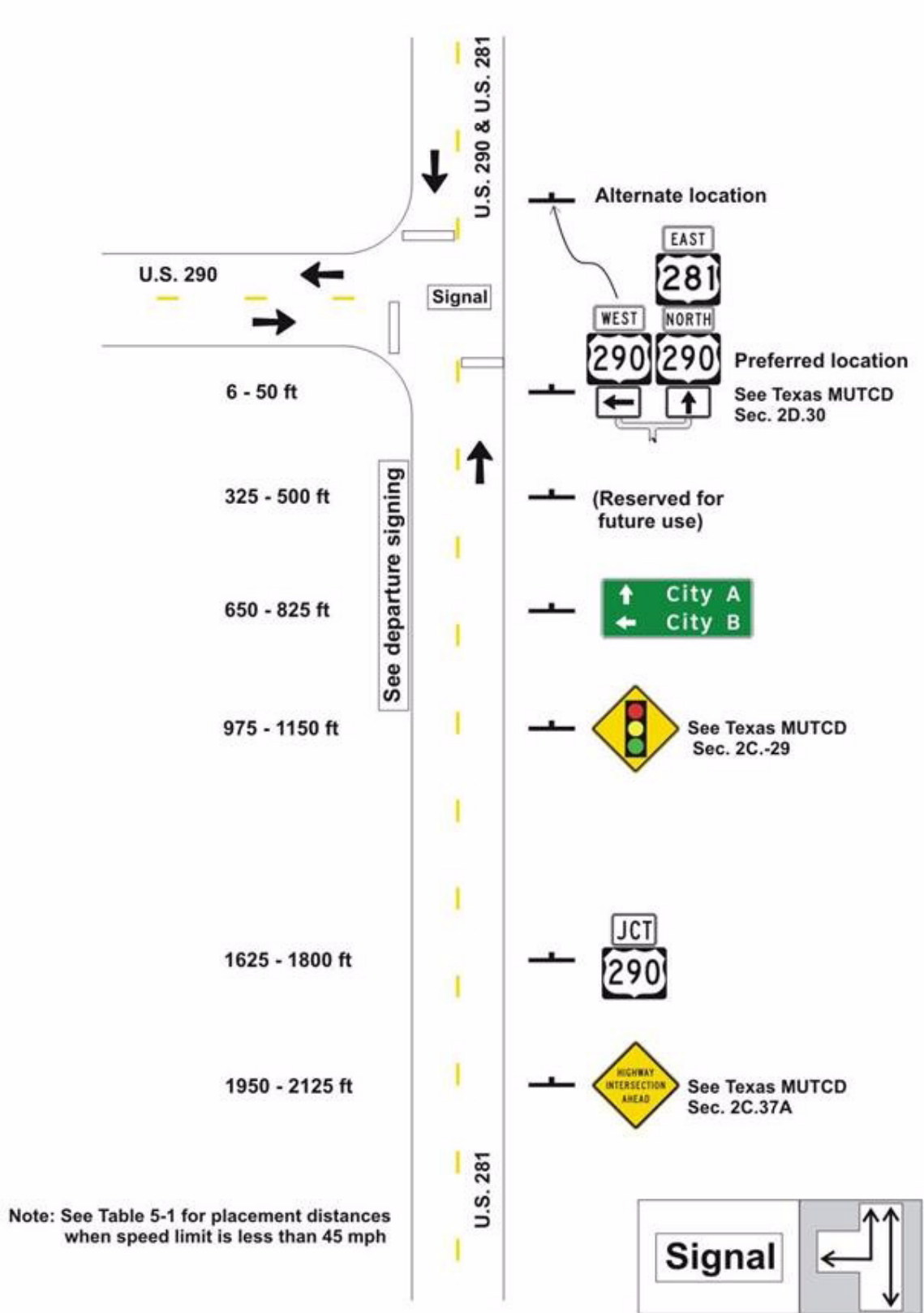

Figure 5-14. 3-Leg Side, 1 Approach Lane, Signal Control, Approach Route Goes Through

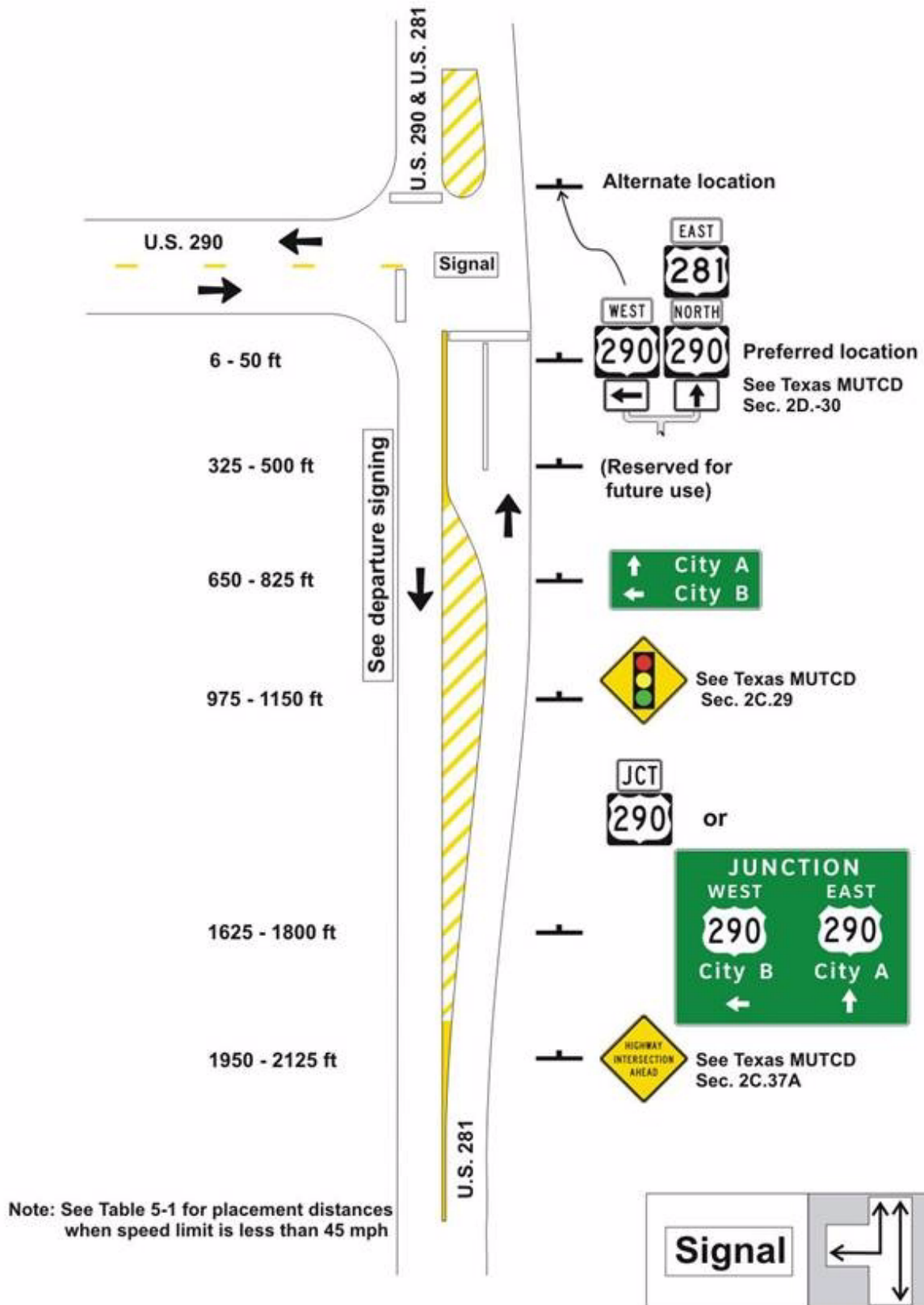

Figure 5-15. 3-Leg Side, 1 Approach Lane + LT, Signal Control, Approach Route Goes Through



## Section 5

### 4-Leg Intersection Illustrations

#### Introduction

This section illustrates the signing placement for an approach to a 4-leg intersection. Each of the figures illustrates how different intersection characteristics affect the signing on the approach.

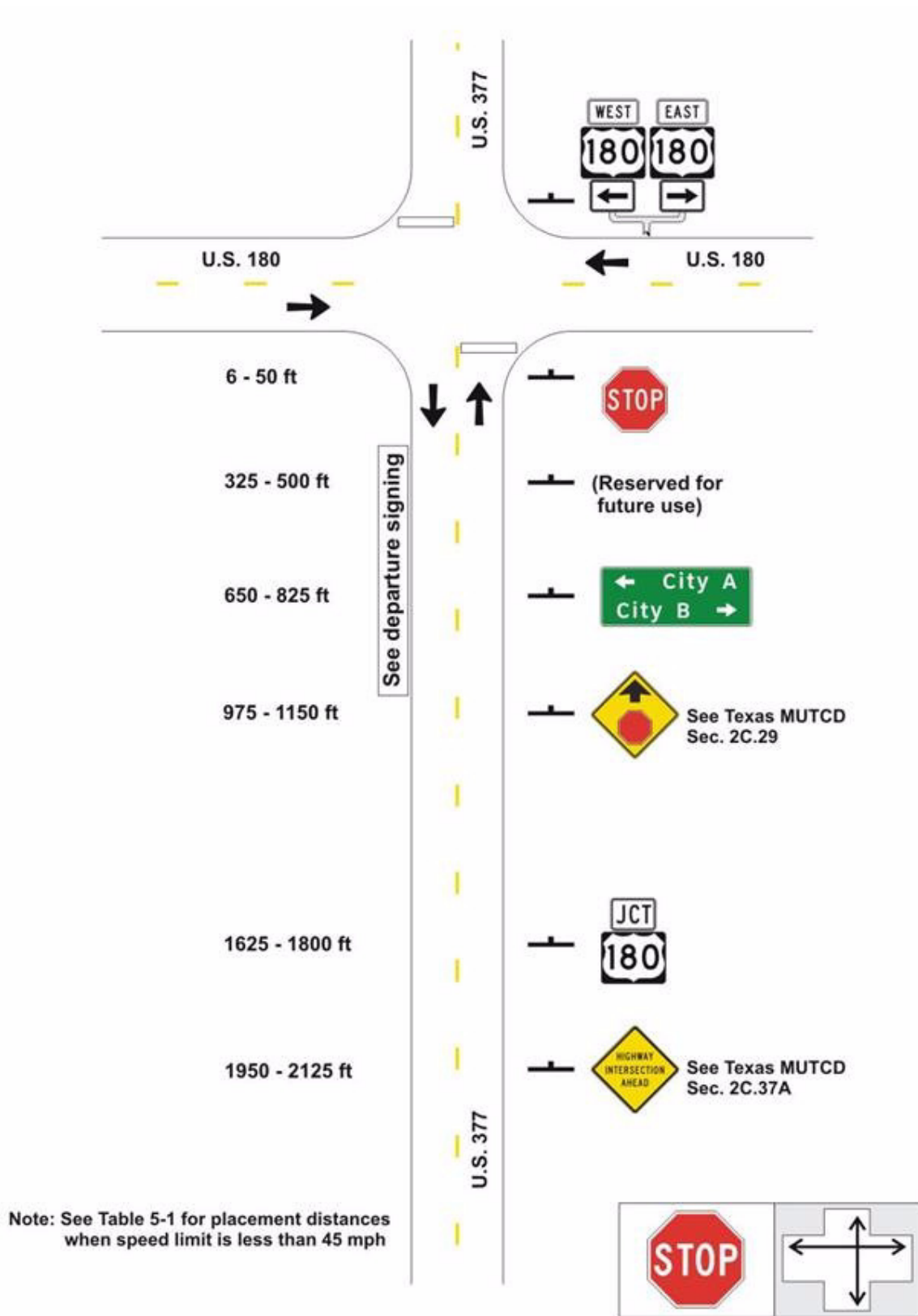

Figure 5-17. 4-Leg, 1 Approach Lane, Stop Control, Approach Route Goes Through



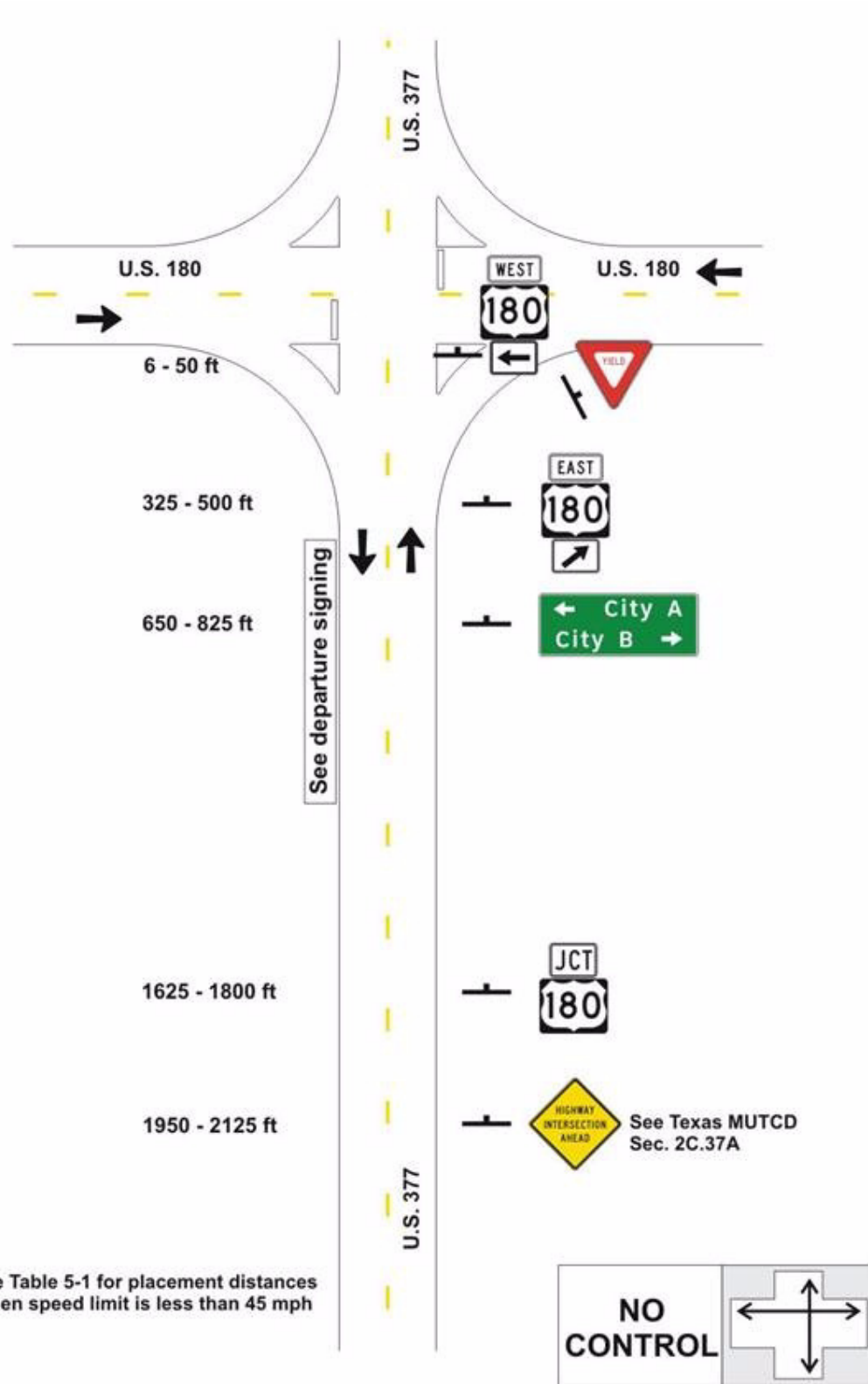

Figure 5-18. 4-Leg, 1 Approach Lane with Free Right Turn, No Control, Approach Lane Goes Through



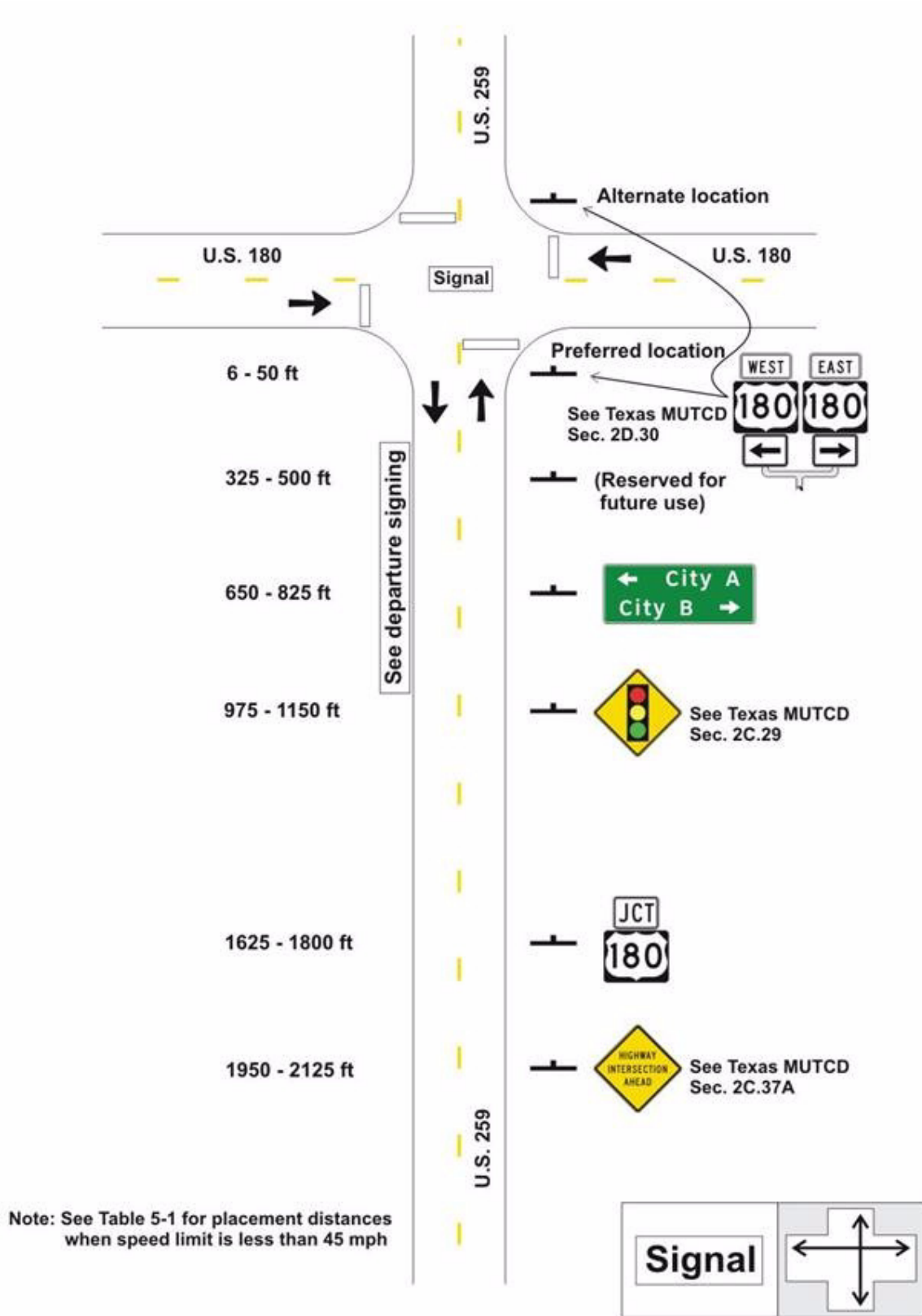

Figure 5-20. 4-Leg, 1 Approach Lane, Signal Control, Approach Route Goes Through

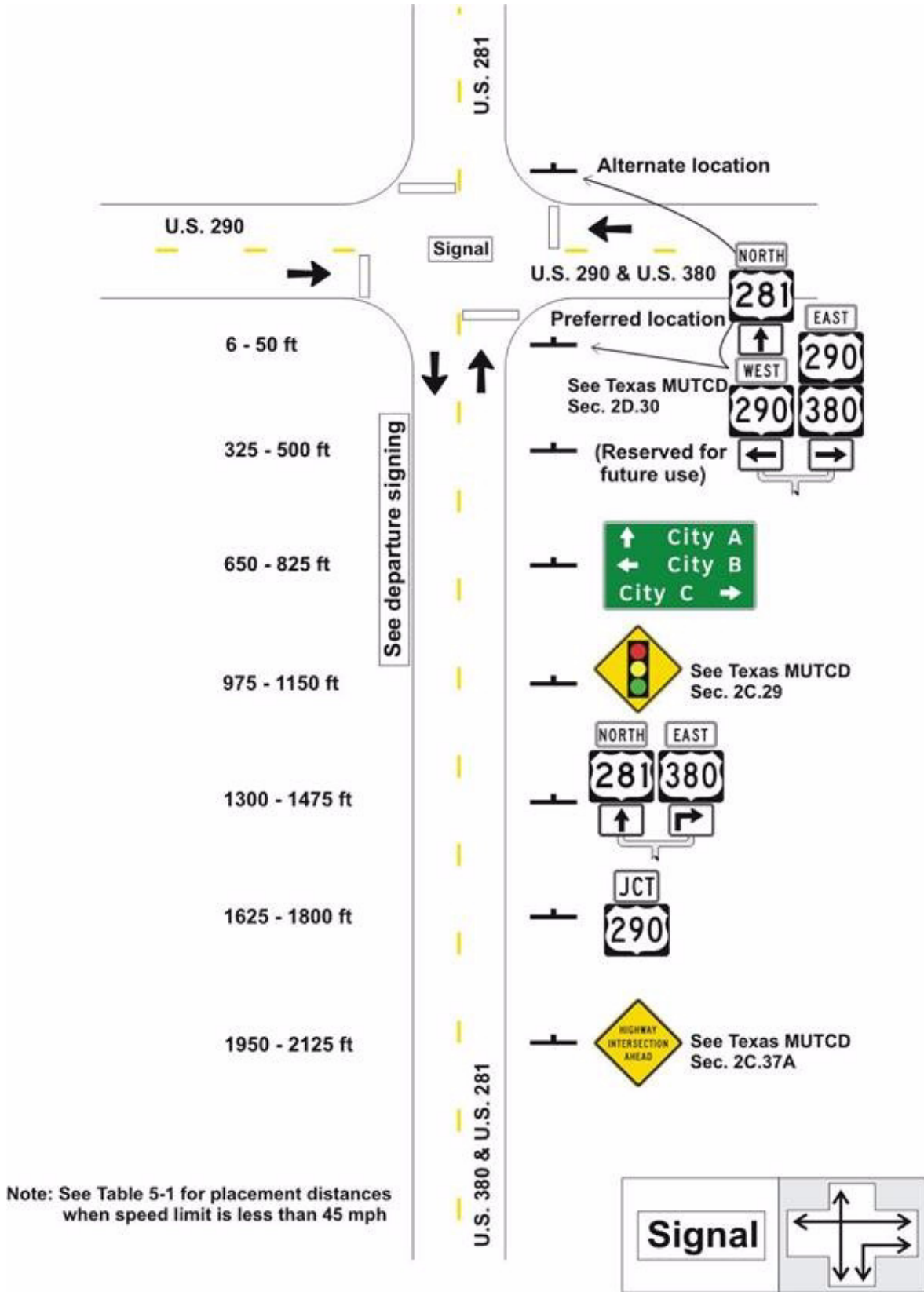

Figure 5-21. 4-Leg, 1 Approach Lane, Signal Control, Approach Route Goes Through & Right

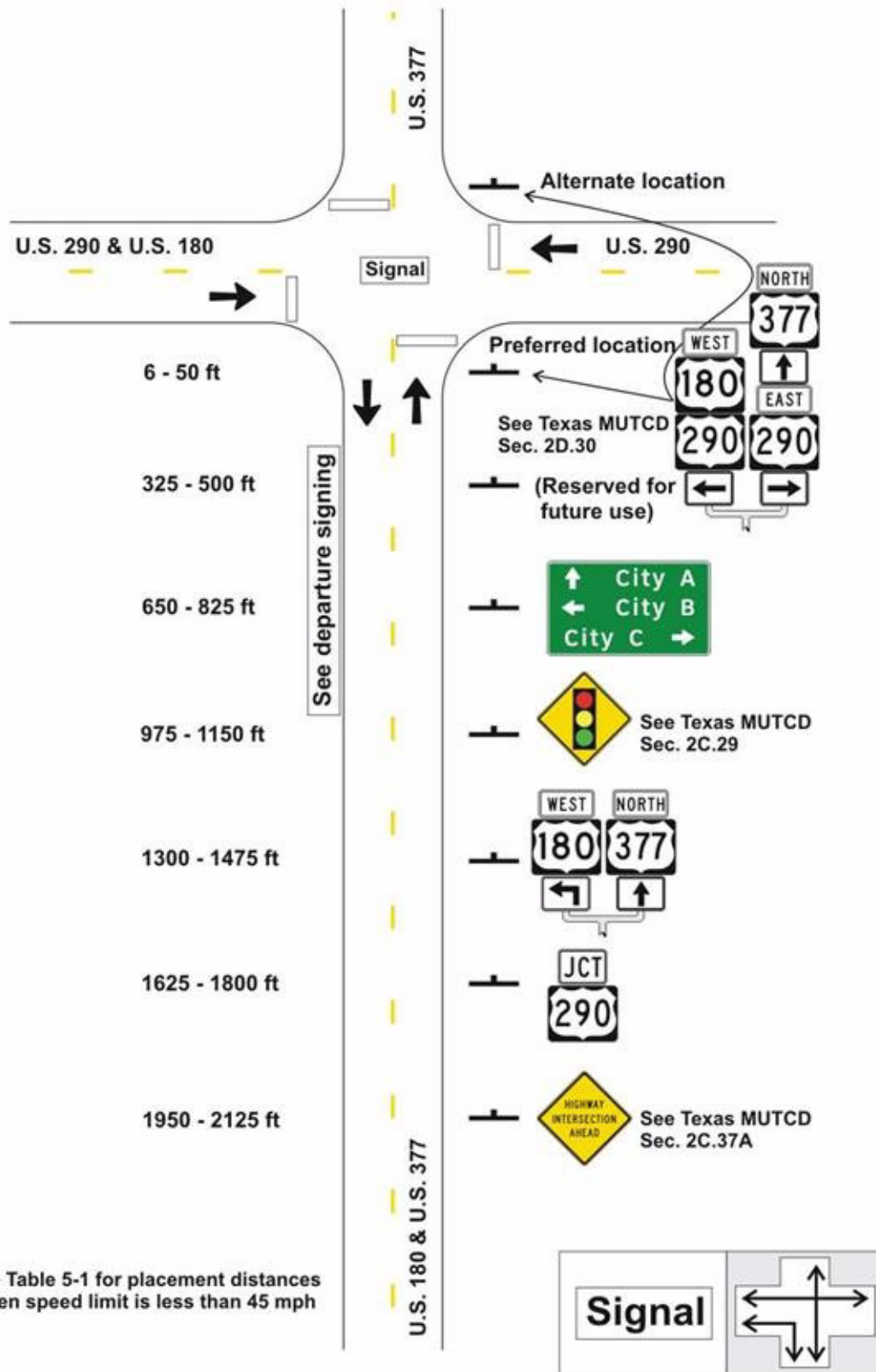

Figure 5-22. 4-Leg, 1 Approach Lane, Signal Control, Approach Route Goes Through & Left

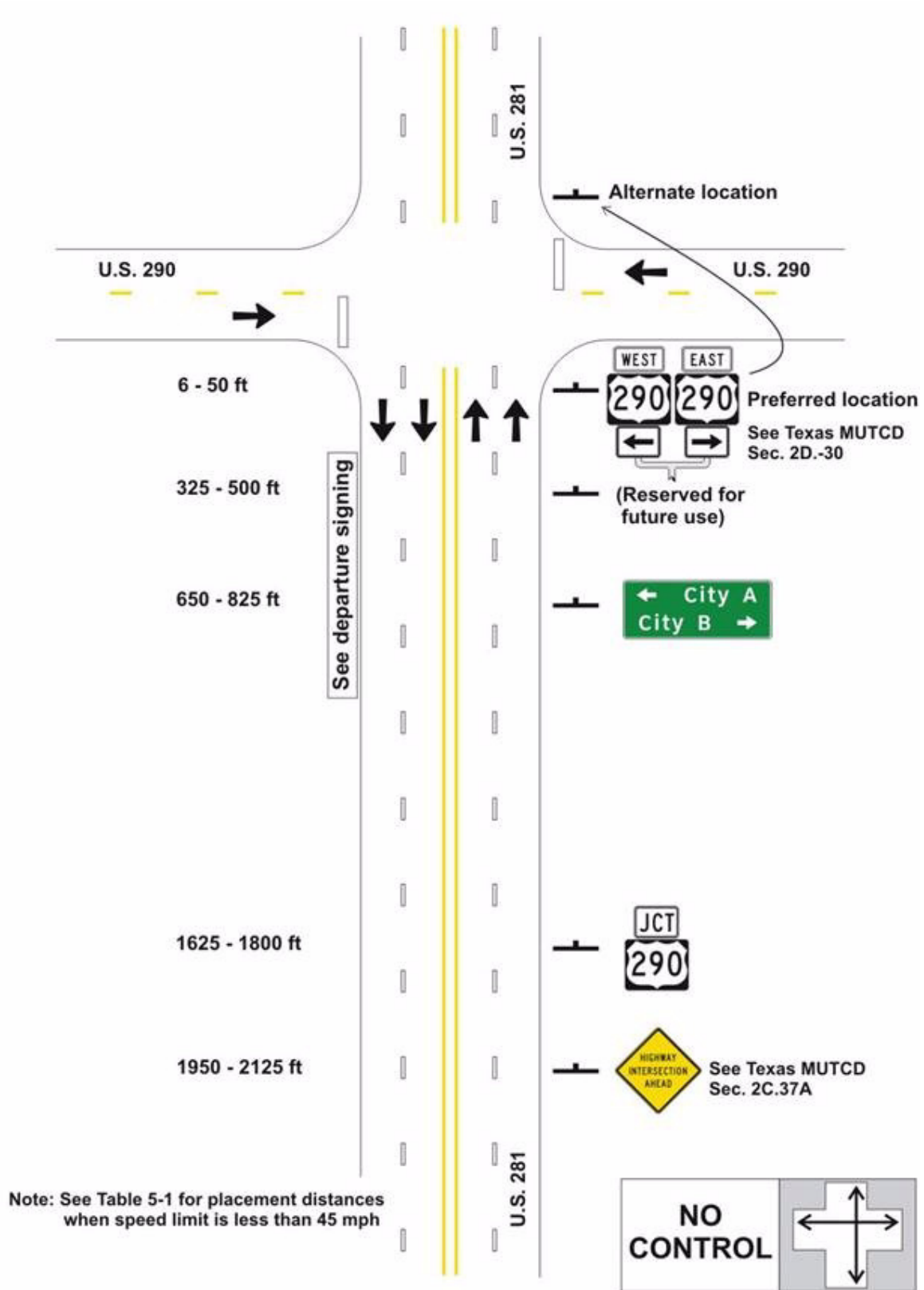

Figure 5-23. 4 Leg, 2 Approach Lanes, No Control, Approach Route Goes Through

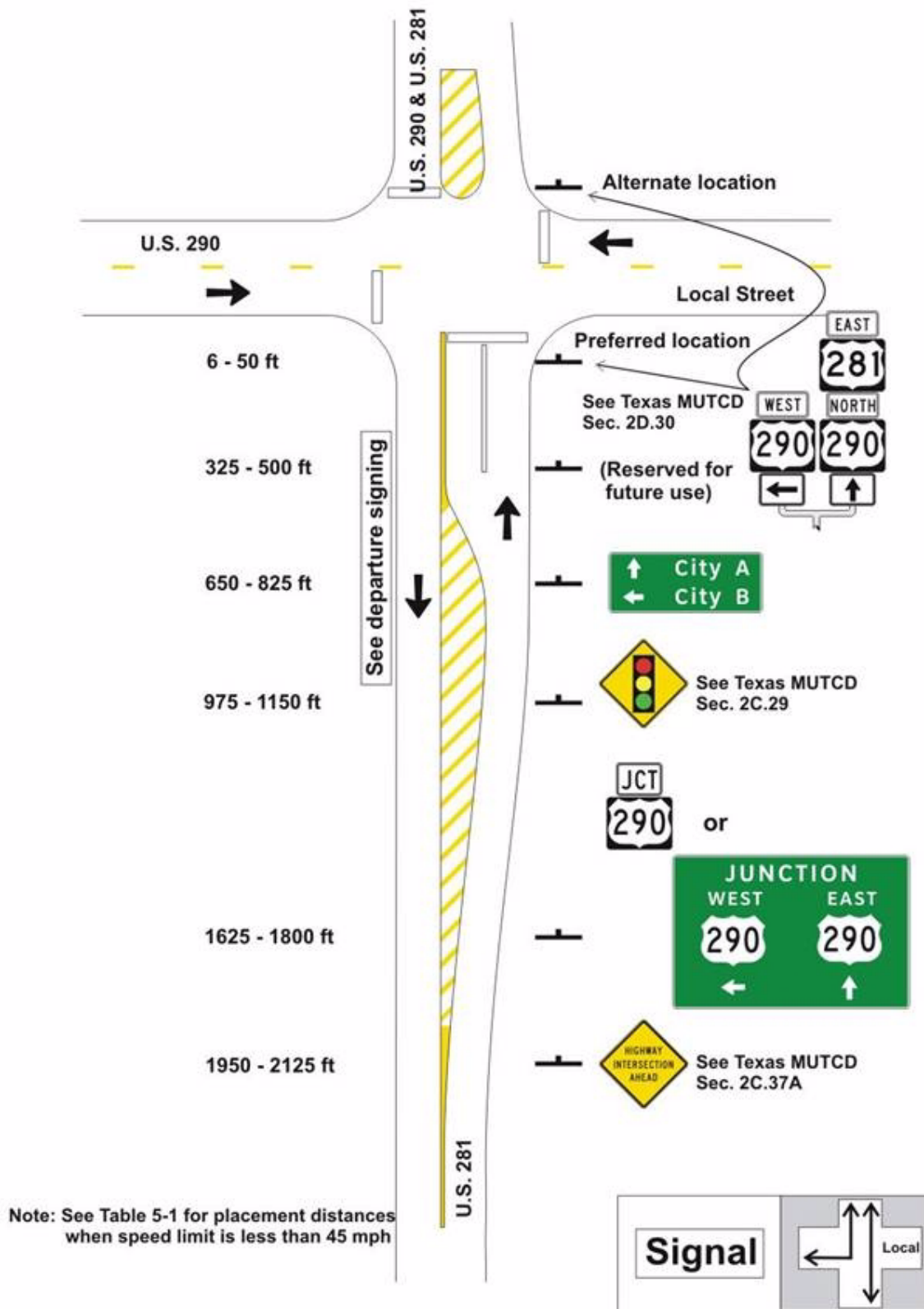

Figure 5-24. 4-Leg, 1 Approach Lane + LT, Signal Control, Approach Route Goes Through

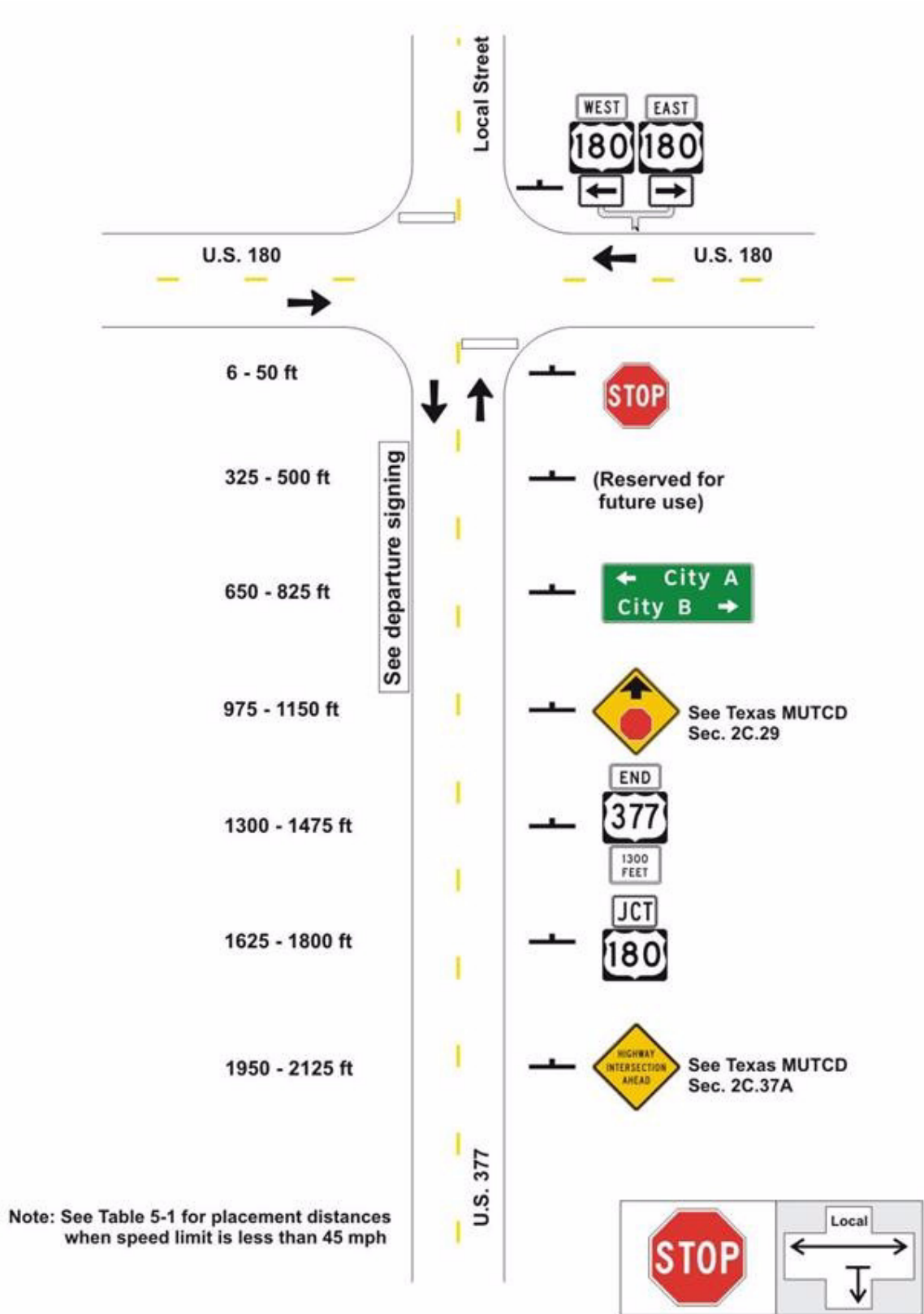

Figure 5-25. 4-Leg with Local Street, 1 Approach Lane, Stop Control, Approach Route Ends



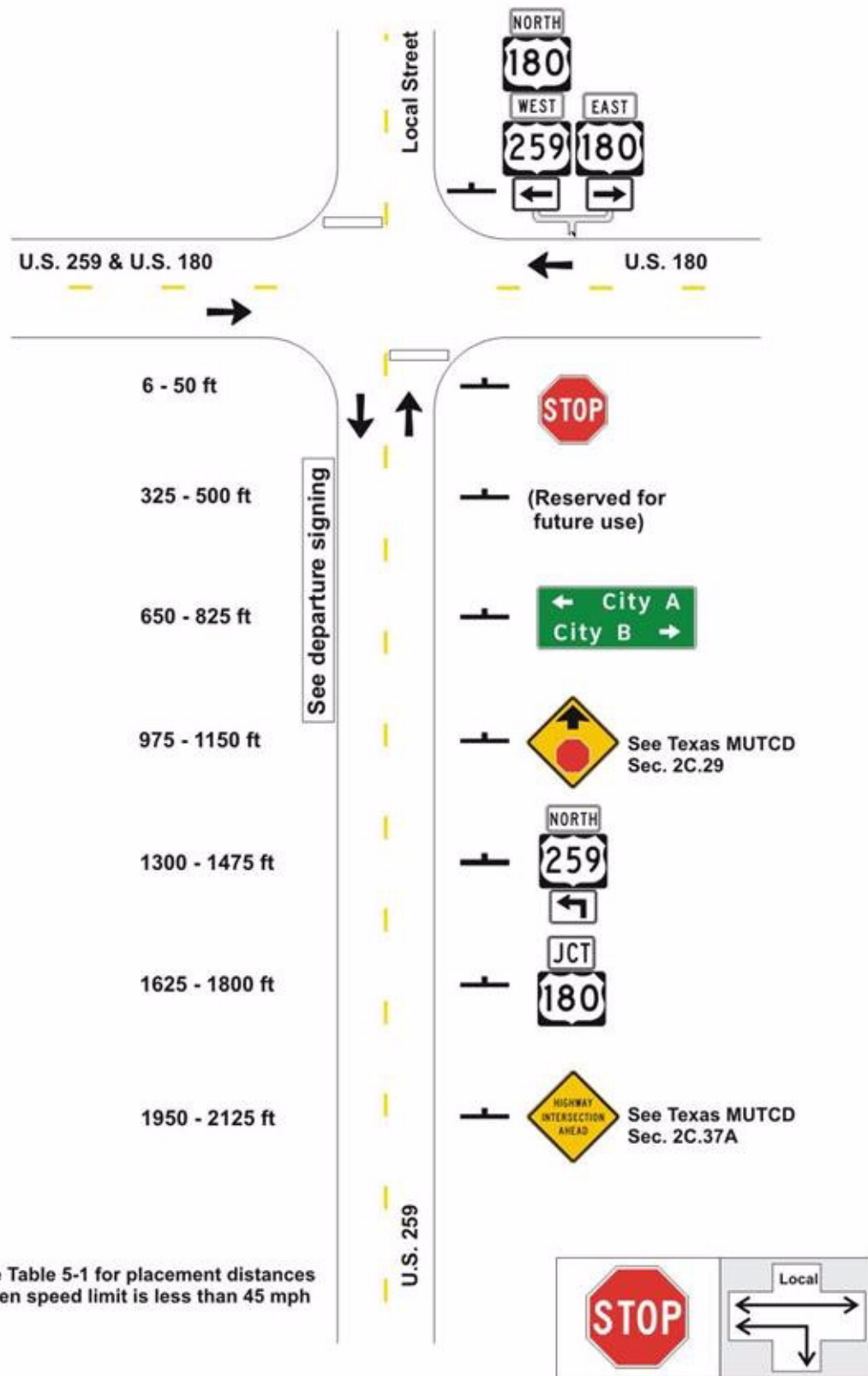

Figure 5-26. 4-Leg with Local Street, 1 Approach Lane, Stop Control, Approach Route Goes Left

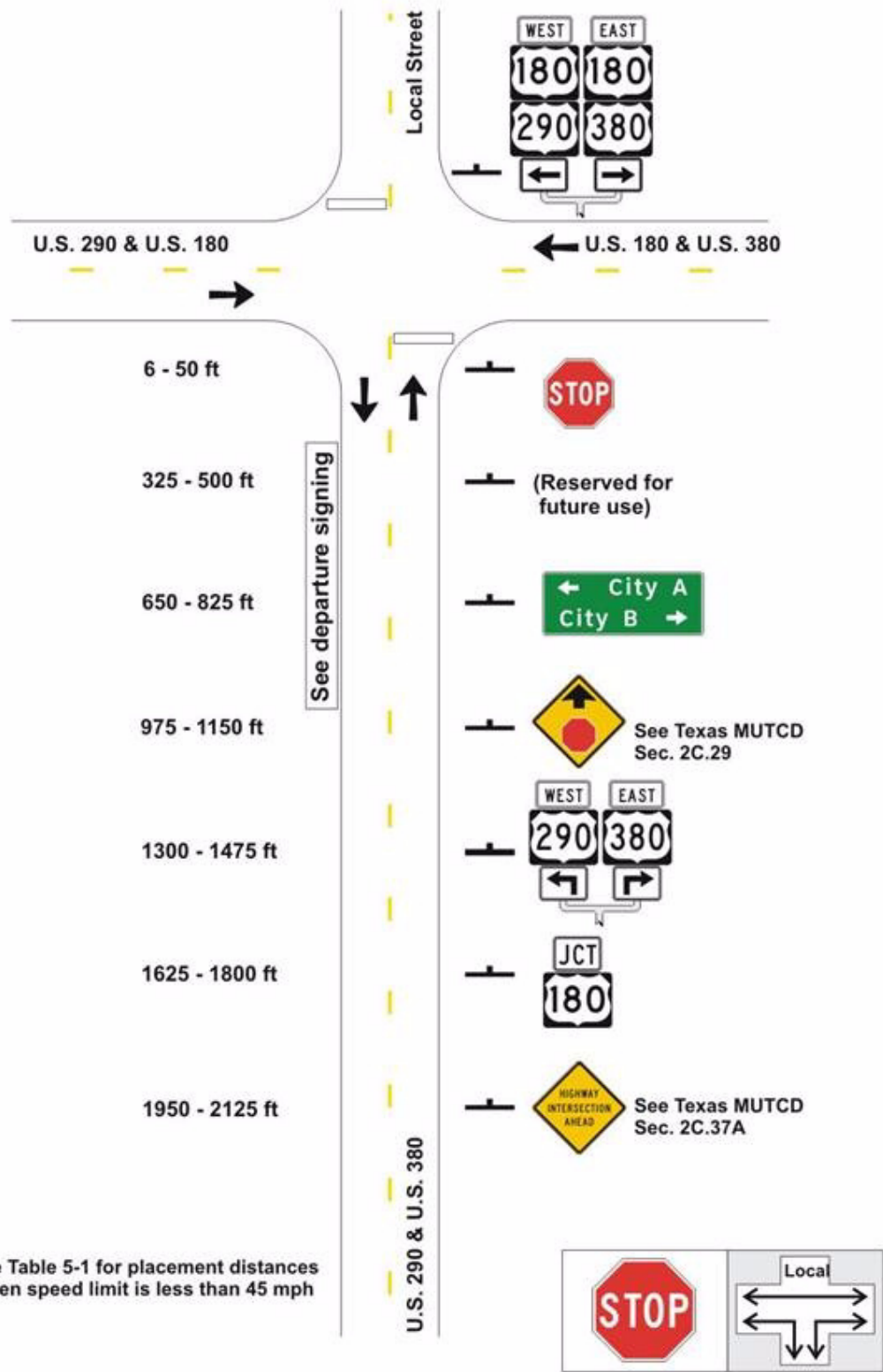

Figure 5-27. 4-Leg with Local Street, 1 Approach Lane, Stop Control, Approach Route Goes Left & Right

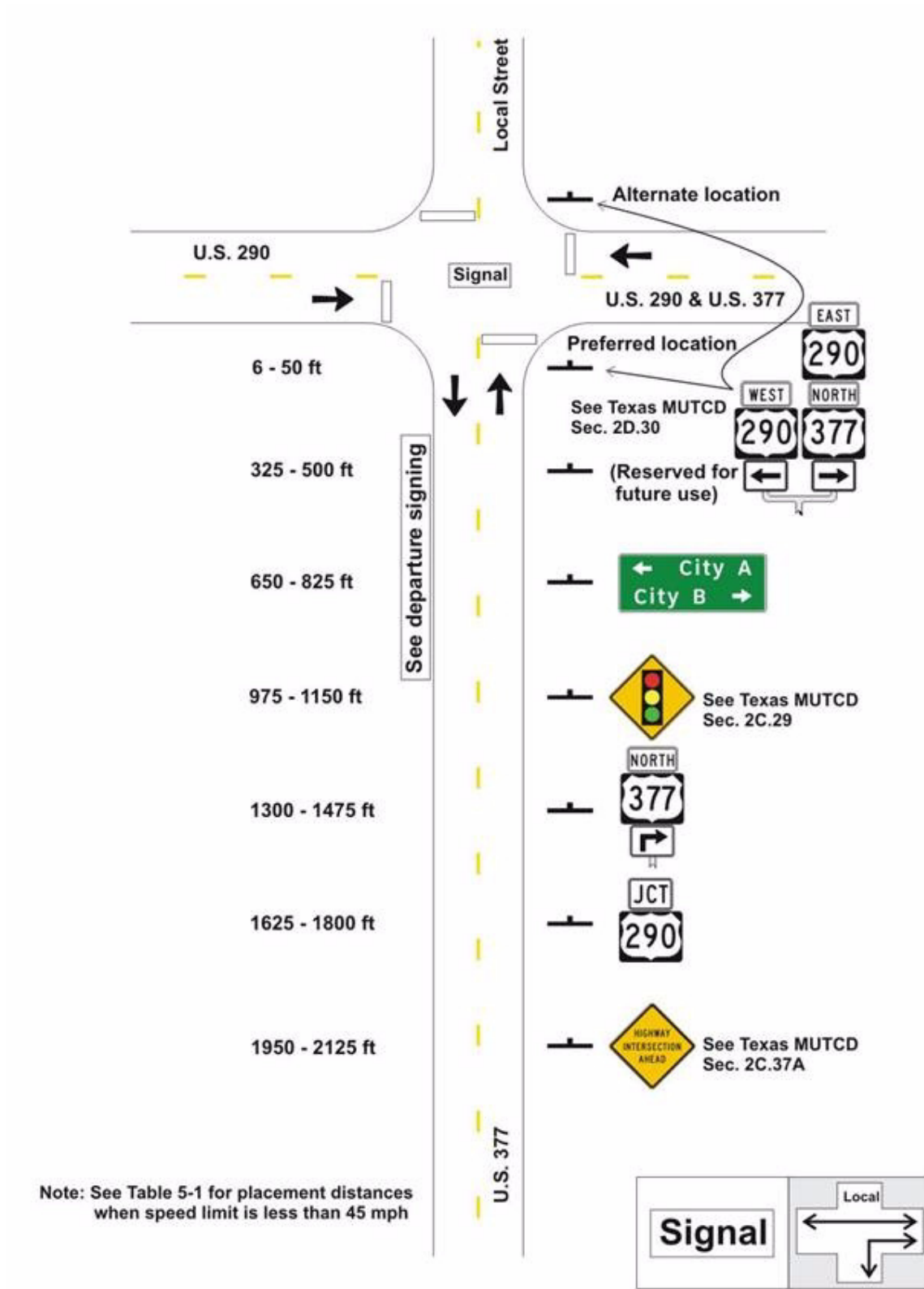

Figure 5-28. 4-Leg with Local Street, 1 Approach Lane, Signal Control, Approach Route Goes Right

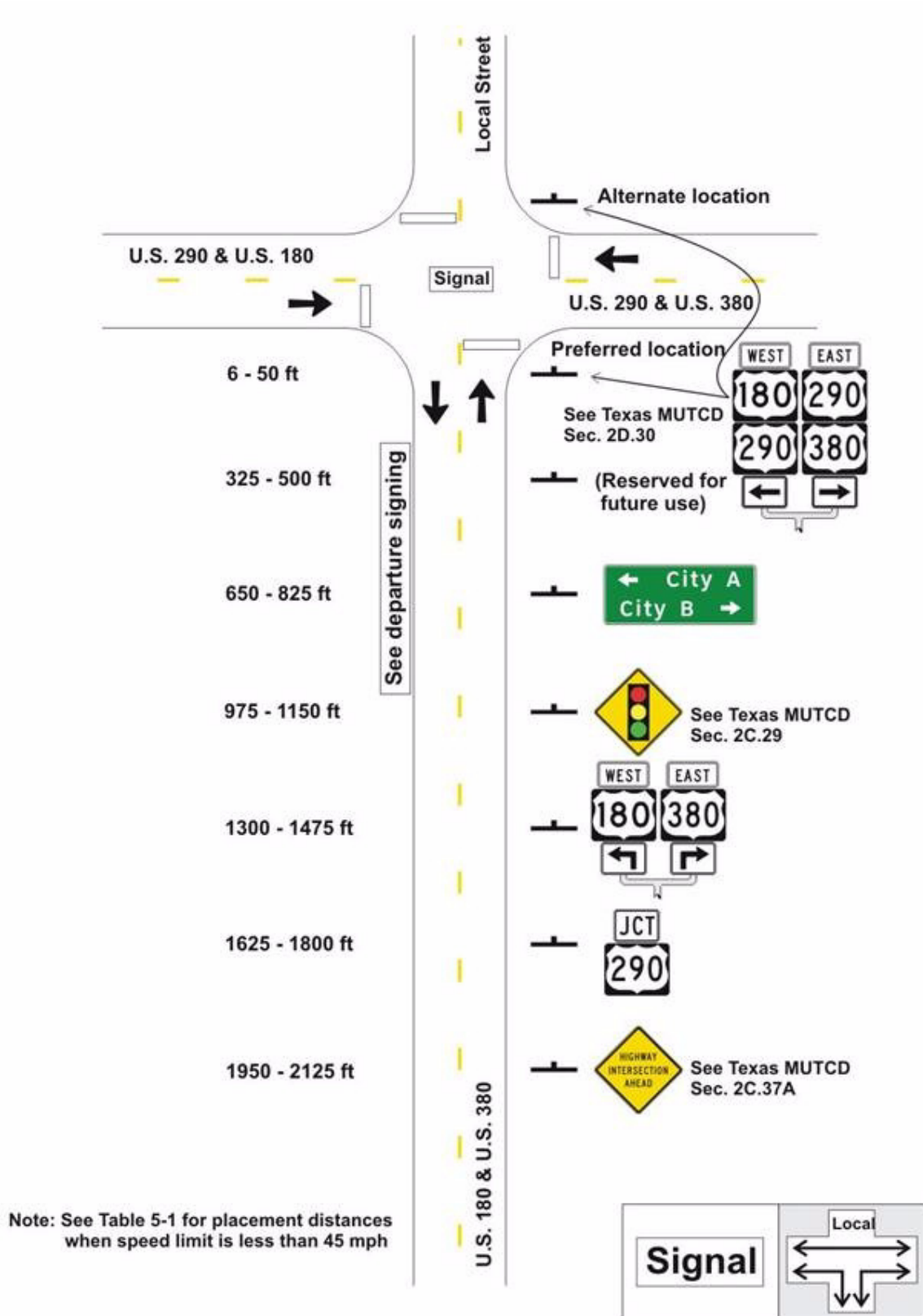

Figure 5-29. 4-Leg, 1 Approach Lane, Signal Control, Approach Routes Go Left & Right

# Chapter 6

## Departure Placement

### Contents:

[Section 1 — Overview](#)

[Section 2 — Basic Departure Placement Considerations](#)

[Section 3 — Intersection Departure Illustrations](#)

## **Section 1**

### **Overview**

#### **Introduction**

The placement of signs on the departure is relatively consistent from one intersection to the next; therefore, the departure placement of these signs is shown in this chapter instead of complicating the figures in the previous chapter with additional information.

The “no sign zone” is also presented in this chapter. Signs should not be located in the no sign zone, if possible.

Placement of signs on the departure is established by maintaining a minimum distance of 325 ft between sign installations.

## Section 2

### Basic Departure Placement Considerations

#### Introduction

The concept of a no sign zone has been developed to improve the probability of a sign being seen by drivers. Where possible, signs should be located beyond the no sign zone.

The two guide sign installations typically located on the departure from a highway intersection, Confirming or Reassurance Assembly and Distance sign, have been moved beyond the no sign zone. These placement locations are further from the intersection than that shown in the Texas MUTCD.

#### Distance Between Departure Signs

The number and types of signs that may be placed on the intersection departure can vary significantly from one intersection to another. There is no set distance that a departure sign should be from the intersection. Instead, the departure signs should be placed so that there are at least 325 ft between signs.

#### Effect of Speed on Placement Distances

Unlike the signing on the approach to an intersection, there are no separate placement distances for lower speed departures. The size of the no sign zone and the minimum distance between departure signs remain the same regardless of the speed.

---

## No Sign Zone

A driver's attention is focused upon maneuvering through the intersection and the associated traffic during the time that the vehicle is passing through the intersection. Once the vehicle passes through the intersection, the driver has to refocus upon the driving task, checking speed, position, and other items. Departure signs that are located within a short distance of the intersection may not be seen by the driver due to the fact that the driver's attention may be focused on other items.

In order to improve the ability of drivers to obtain the appropriate guidance information, a "no sign zone" should be established from the intersection to a point approximately 200 to 300 ft beyond the intersection. Signs should not be placed in this zone, if possible.

- ◆ **Departure Signs beyond the No Sign Zone** – Wherever practical, signs located on the departure leg of an intersection should be located beyond the no sign zone. Examples of these signs include:
  - **Confirming or Reassurance Assembly** – This assembly should be located no closer than 200 ft from the intersection unless a Texas Reference Marker is attached to the assembly.
  - **Speed Limit sign** – This sign is typically used when the speed limit on the departure is different from the speed on any of the approaches.
  - **Distance sign** – This sign should be one of the last in the series of intersection departure signs.
- ◆ **Departure Signs in the No Sign Zone** - In some cases, it may be necessary to place signs at the beginning of the departure. These signs are generally used to indicate a prohibition or restriction that the road user needs to be aware of before turning onto the departure roadway. These signs should be located at the intersection prior to the beginning of the no sign zone. However, before placing a sign in the no sign zone, the impacts of locating the sign further from the intersection (beyond the no sign zone) should be considered.



Examples of types of signs that might be located in the no sign zone include:

- ◆ **Regulatory signs** – Typically indicate a regulation or prohibition that begins at the intersection. Examples include:
  - Keep Right signs (R4-7 series, in divisional island).
  - Do Not Enter signs (R5-1 series).
  - Vehicle, Pedestrian, and Bicycle Prohibition signs (R5-2 through R5-10).
  - One Way signs (R6-1 and R6-2).
  - Road Closed signs (R11-2 through R11-4).
  - Weight Limit signs (R12 series).
  - Width Restriction sign (R12-9 and R12-9a).
  - Hazardous Cargo Prohibition sign (R14-2 and R14-3).
  - Crossbuck (R15-1).
- ◆ **Warning signs** – Typically warn of a potential hazard located a short distance beyond the intersection. Examples include:
  - Turn/Curve signs (W1-1 through W1-5, W1-11, W1-11T, W1-11p, and W1-15T).
  - Advance Railroad Warning signs (W10 series).
  - Crossing signs (W11 and S1 series).
  - Vertical Clearance sign (W12-2, W12-2Tp, W12-3p, and W12-4).
  - Load Zoned Bridge sign (W12-5).
  - Dead End signs (W14-1T, W14-1, W14-2, W14-1p, and W14-2).
- ◆ **Construction signs** – If possible, locate construction signing beyond the no sign zone.
- ◆ **General information signs** – Signs that do not serve a traffic control function.
- ◆ **Other Signs** – Signs that are related to some aspect or physical characteristic of the intersection where it would be inappropriate to locate the sign away from the intersection. Examples include:
  - Texas Reference Marker.
  - State Maintenance Begins (D28).

## **Section 3**

### **Intersection Departure Illustrations**

#### **Introduction**

Figures 6-1, 6-2, and 6-3 illustrate the placement of signs on the departure, the no sign zone concept, and the minimum separation distance between signs.

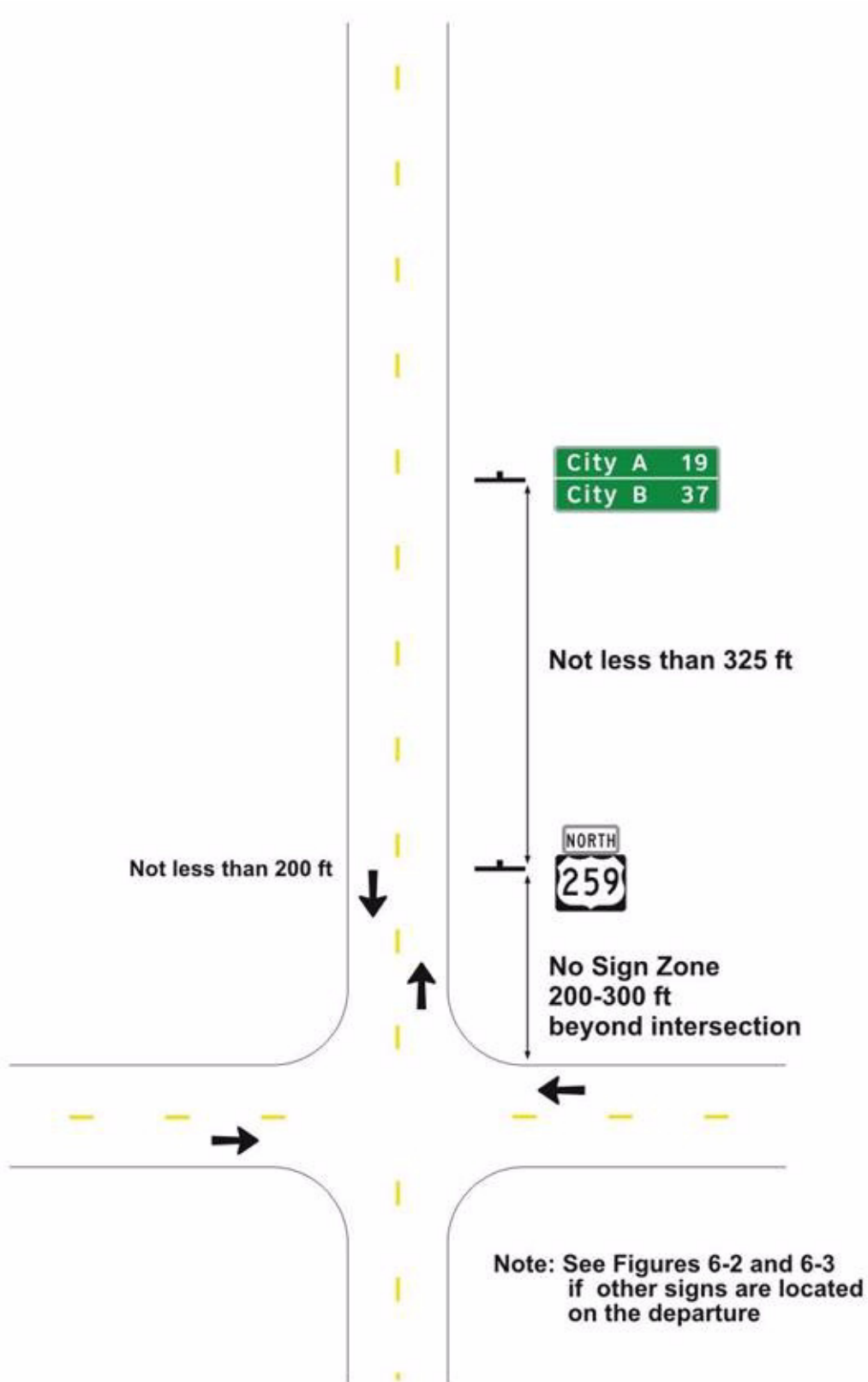

Figure 6-1. Departure Sign Placement Guide Signs beyond the No Sign Zone

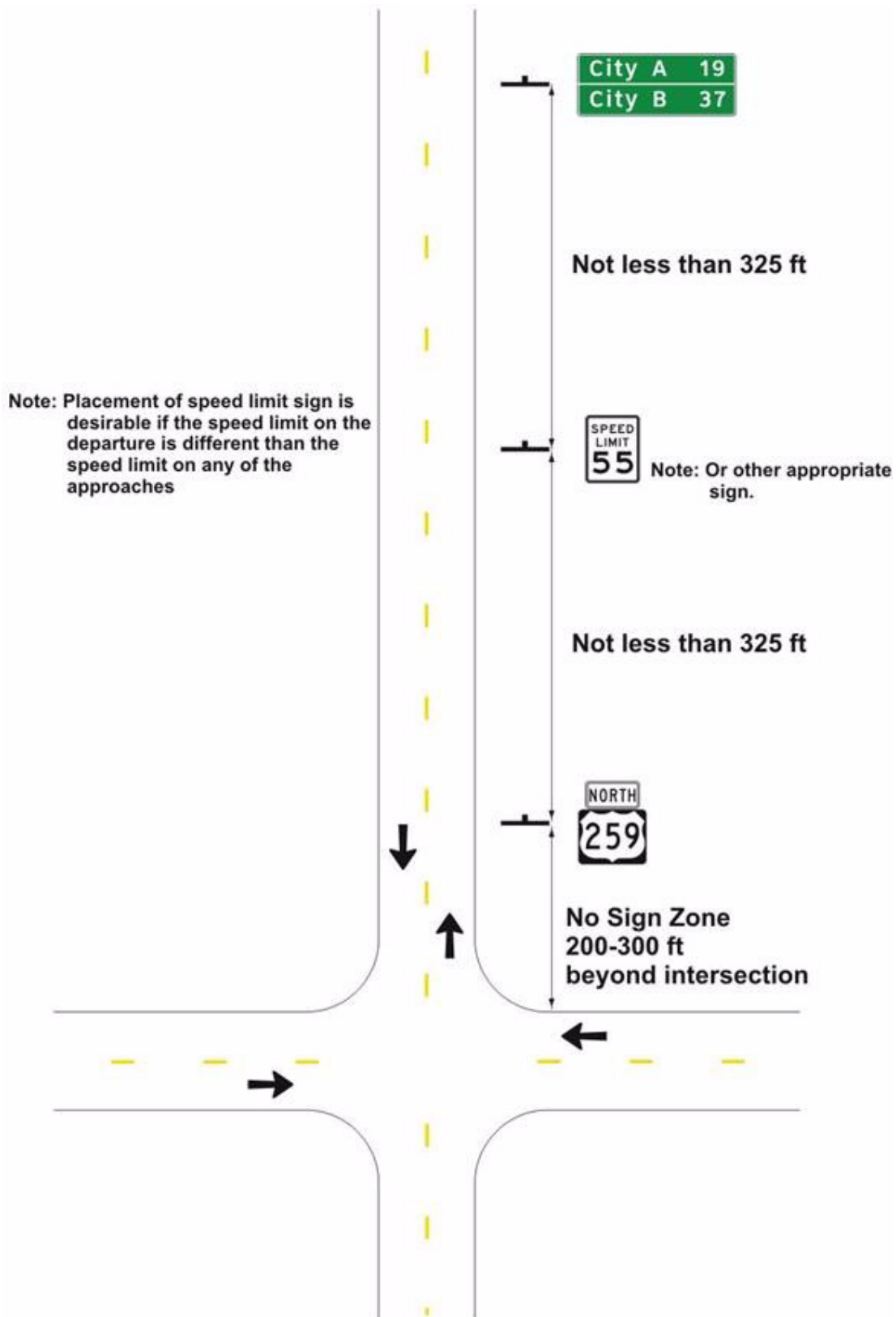

Figure 6-2. Departure Sign Placement, Multiple Signs beyond the No Sign Zone

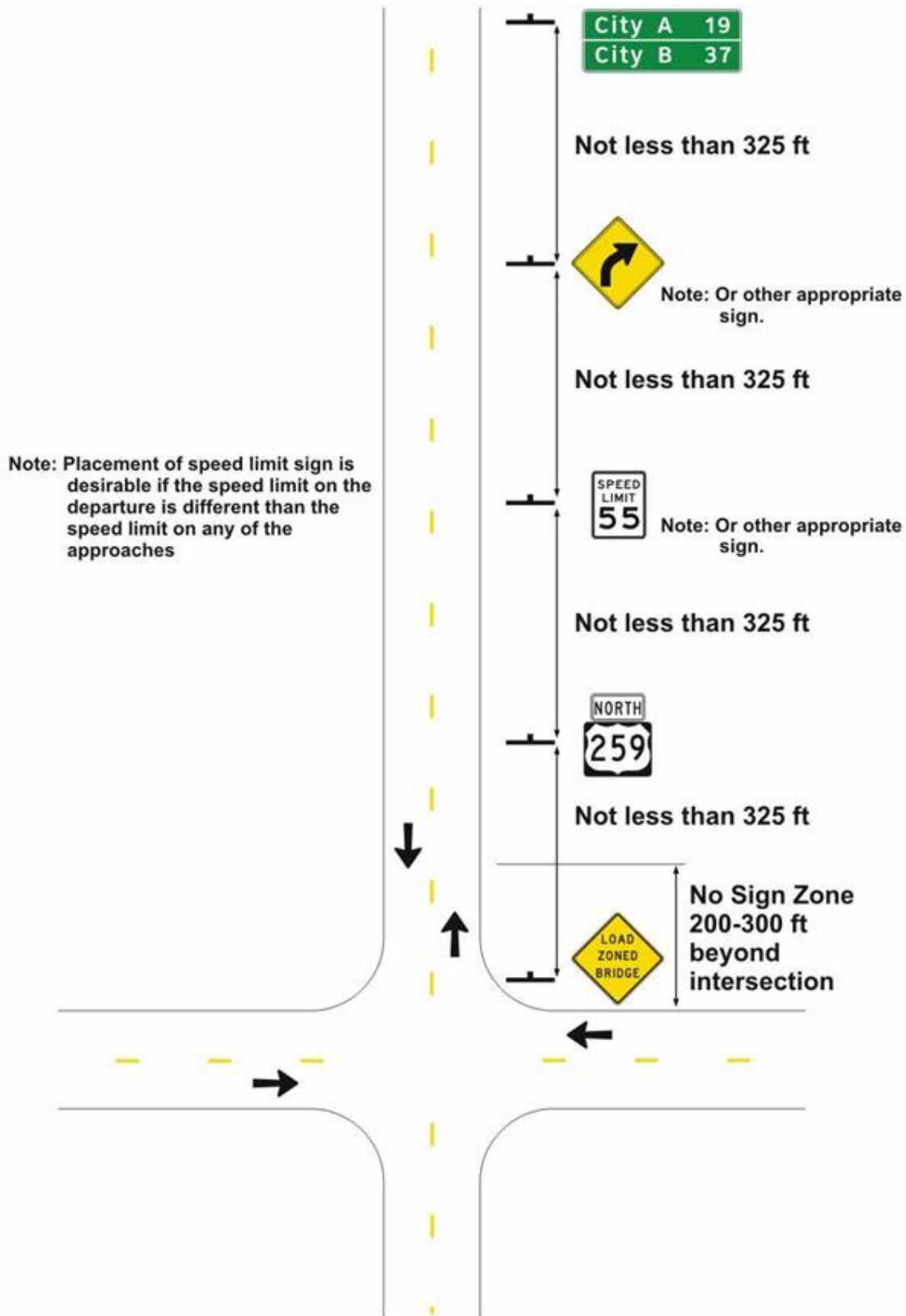

Figure 6-3. Departure Sign Placement, Signs Located within the No Sign Zone

# Chapter 7

## Special Signing Situations

### Contents:

[Section 1 — Overview](#)

[Section 2 — Divided Highway Intersections and Crossovers](#)

[Section 3 — Overlapping Routes](#)

[Section 4 — Road Ends](#)

[Section 5 — Interchange Applications](#)

[Section 6 — Lane Drop Applications](#)

## Section 1

### Overview

#### Introduction

This chapter describes some special applications related to the use of guide signs on conventional highways that are not covered in Chapters 5 or 6. Many of these signs are common guide signs, but do not fall into a typical highway intersection category. Therefore, they are discussed in this chapter, which covers special guide signing applications.

This chapter contains numerous drawings that illustrate some of the unique situations that are common. The situations are divided into the following general categories:

- ◆ Divided Highway Intersections and Crossovers
- ◆ Overlapping Routes
- ◆ Road Ends
- ◆ Interchange Applications
- ◆ Lane-Drop Applications

## Section 2

### Divided Highway Intersections and Crossovers

#### Introduction

Intersections at divided highways and crossovers between directions of a divided highway have special signing needs due to the complexity of the intersecting area. Medians with widths of 30 ft or more are signed as two separate intersections (Texas MUTCD Section 2A.23). The figures in this section illustrate placement of signs such as One-Way, Do Not Enter, Route Assemblies, and Yield.

#### Median Width

The median width is a critical factor in defining how a divided highway intersection or crossover operates. As such, it has an important impact on the signs used. Medians are classified as wide or narrow. In a wide median, the opposing left-turn paths cross each other. In a narrow median, the opposing left turns do not cross. Figure 7-1 illustrates this difference.

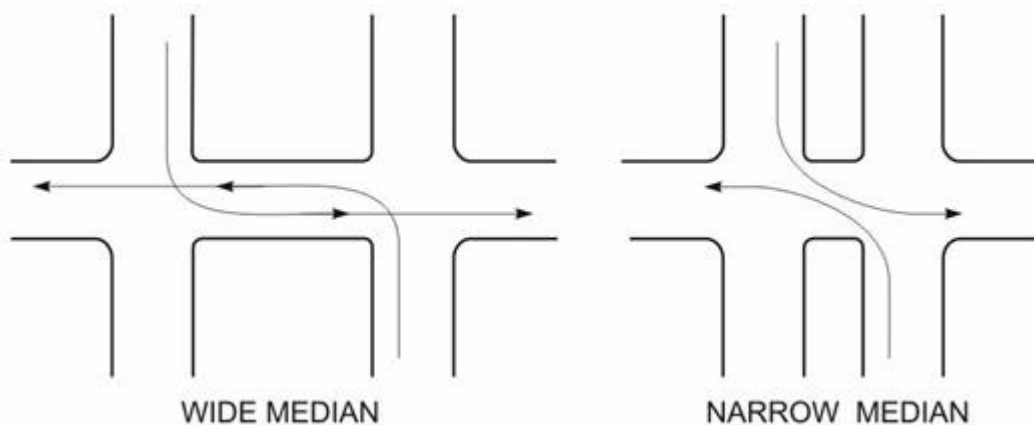

Figure 7-1. Difference in Operations between a Wide and Narrow Median

The median width is measured between the inside of the left turn lanes, or if there is no left turn lane on an approach, from the inside through lane. The types of medians are defined below. Figure 7-2 illustrates how to measure median width.

- ◆ **Wide Median:** the distance between left turn lanes (or through lane if there is no left turn lane) is 30 ft or more.
- ◆ **Narrow Median:** the distance between left turn lanes (or through lane if there is no left turn lane) is less than 30 ft.



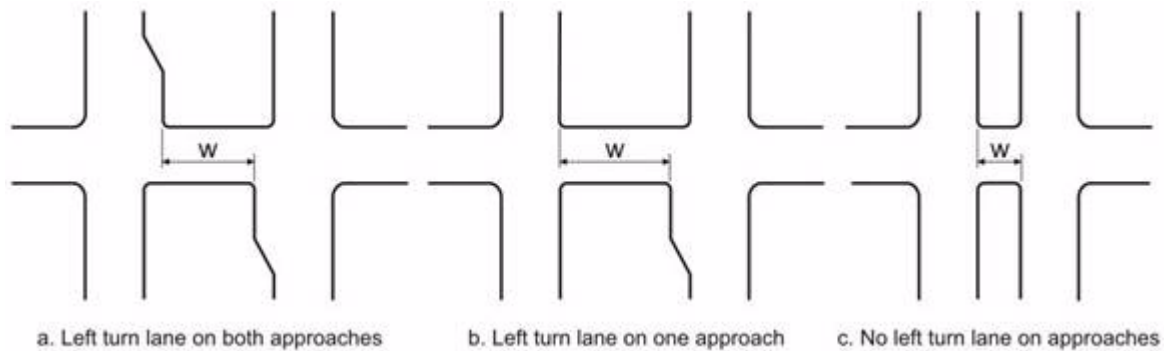

Figure 7-2. Measuring Median Width

### Markings for Divided Highway Intersections and Crossovers

Stop lines, Yield lines, and centerlines are not used within the median area of narrow medians.

### Delineation for Divided Highway Intersections and Crossovers

Chapter 7 provides guidance on delineating divided highway intersections and crossovers.

### Divided Highway Intersections

Divided highway intersections are ones where there is an external leg intersecting with one or both of the through roadways. For the illustrations in this section, the vehicle approaching the divided highway has the option of turning left or right (in other words, there is a median opening).

This section presents the following divided highway illustrations:

- ◆ Figure 7-3: Wide median with left turn bays and an external state road on one side.
- ◆ Figure 7-4: Wide median with left turn bays and an external state road on both sides.
- ◆ Figure 7-5: Wide median with no left turn bays and an external state road on one side.
- ◆ Figure 7-6: Narrow median with left turn bays and an external state road on one side.
- ◆ Figure 7-7: Narrow median with left turn bays and an external state road on both sides.
- ◆ Figure 7-8: Narrow median with no left turn bays and an external state road on one side.
- ◆ Figure 7-9: Wide median with no left turn bays and an external local road on one side.

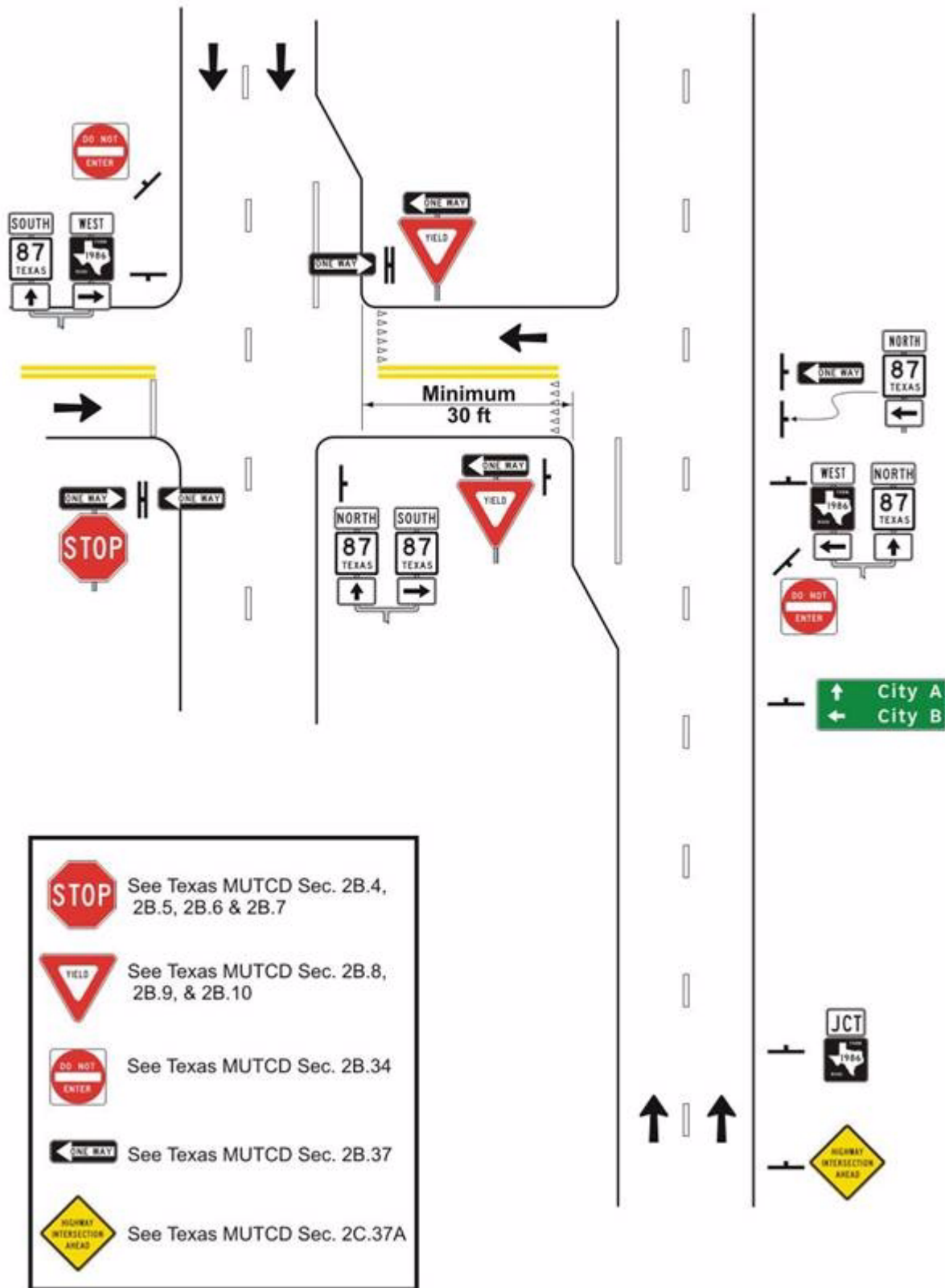

Figure 7-3. Signing for Wide Median Divided Highway Intersection with Left Turn Bay and One External Road

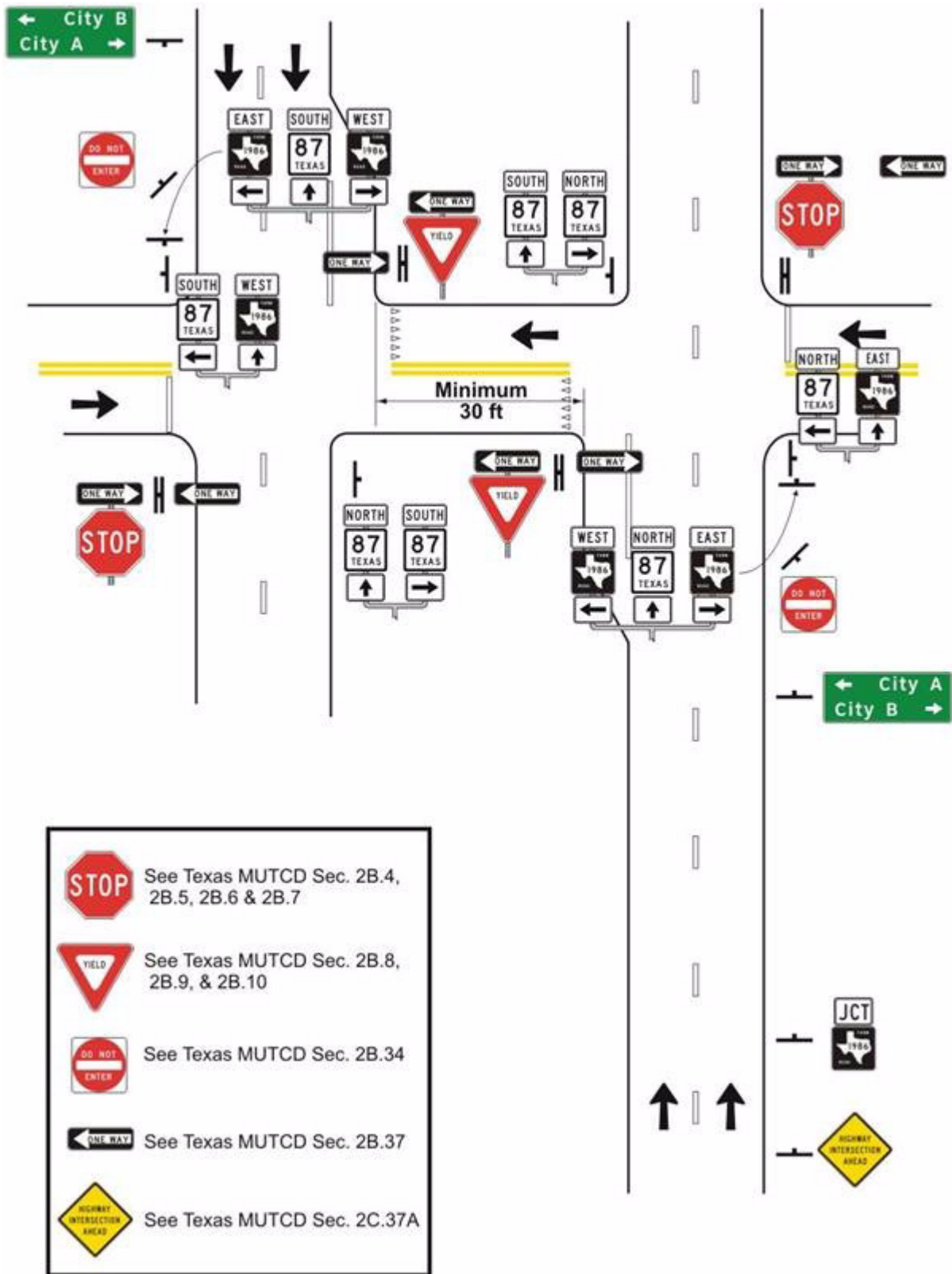

Figure 7-4. Signing for Wide Median Divided Highway Intersection with Left Turn Bay and Two External Roads

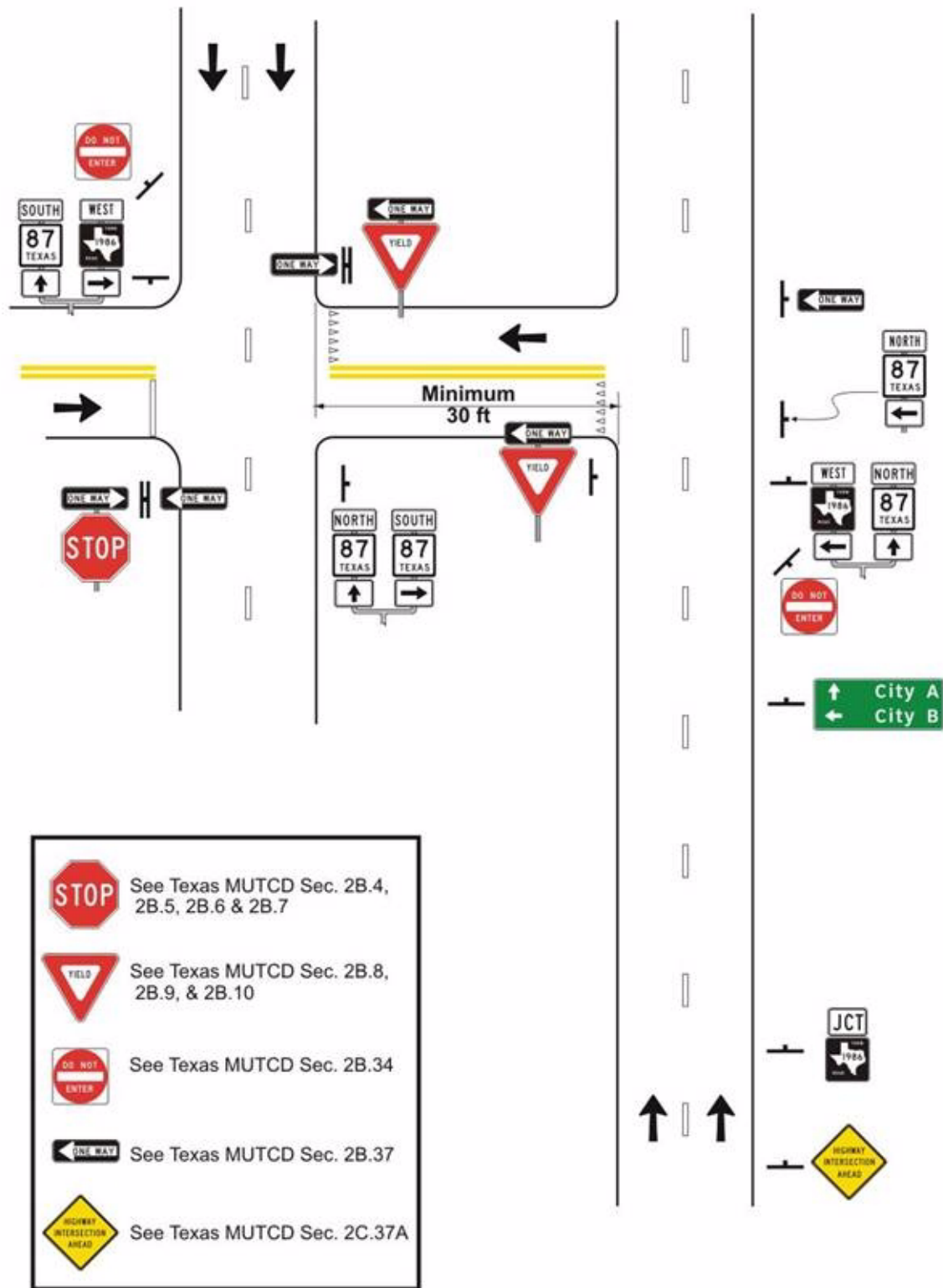

Figure 7-5. Signing for Wide Median Divided Highway Intersection without Turn Bay and One External Road

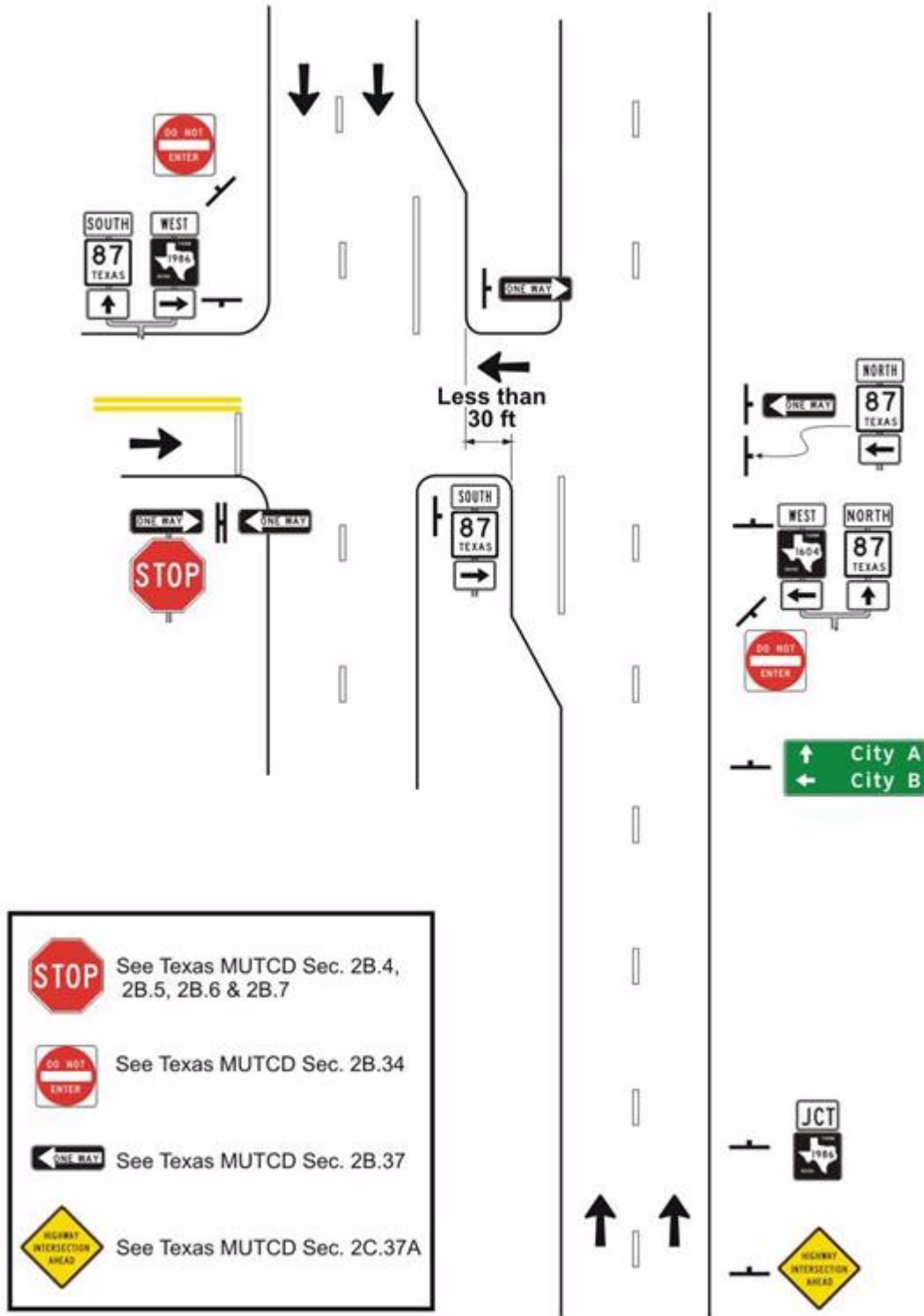

Figure 7-6. Signing for Narrow Median Divided Highway Intersection with Left Turn Bay and One External Road

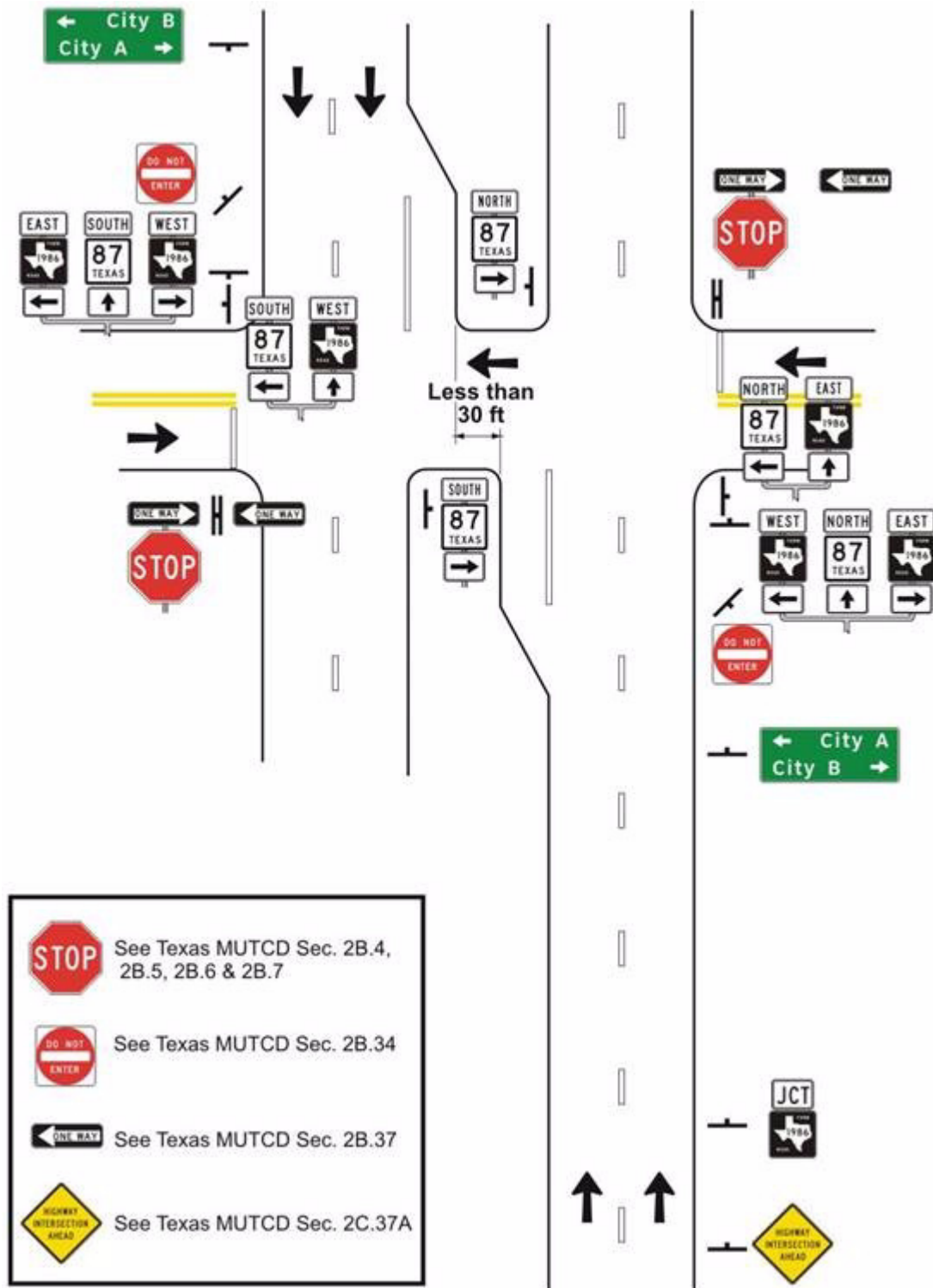

Figure 7-7. Signing for Narrow Median Divided Highway Intersection with Left Turn Bay and Two External Roads

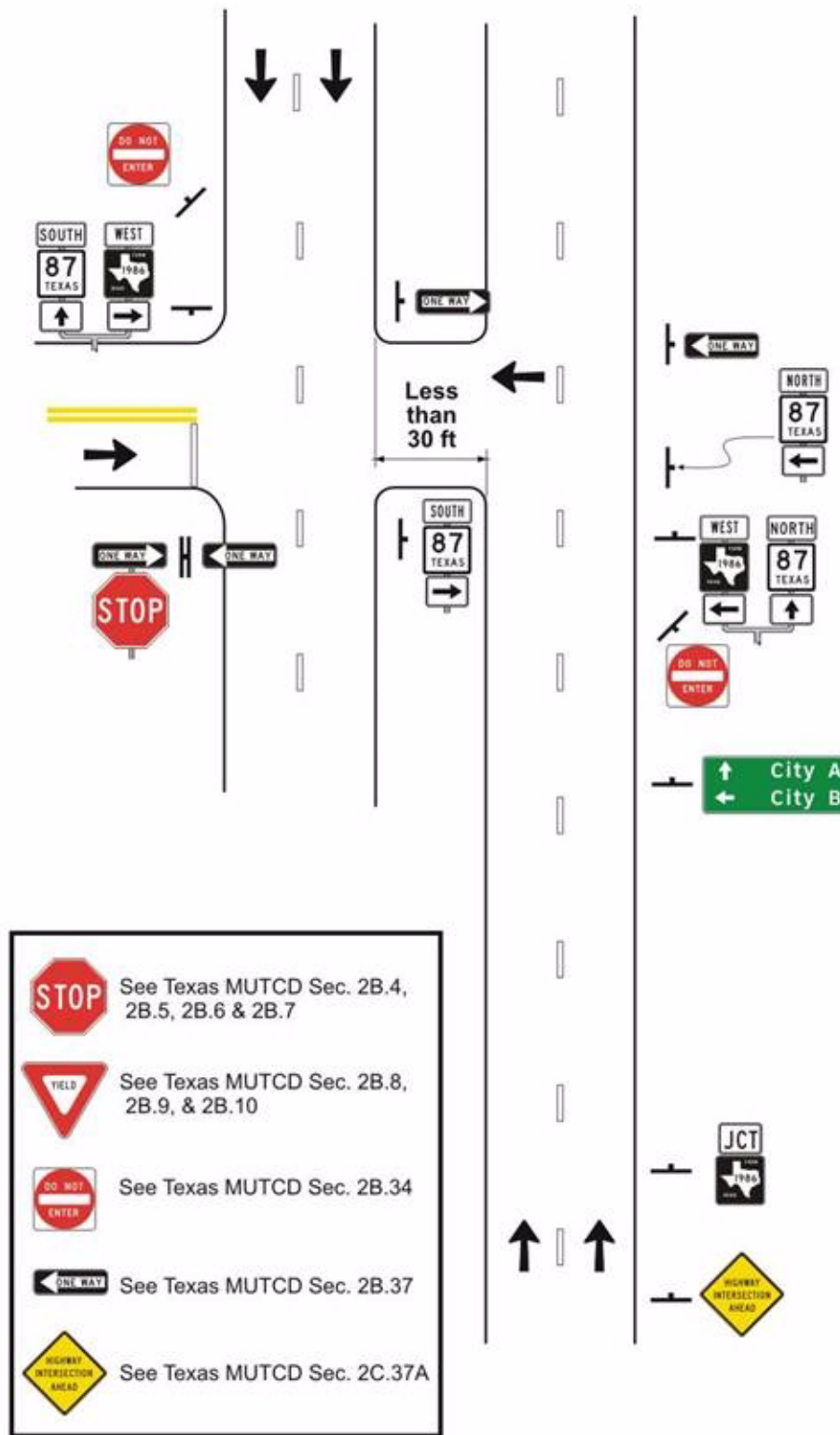

Figure 7-8. Signing for Narrow Median Divided Highway Intersection without Turn Bay and One External Road

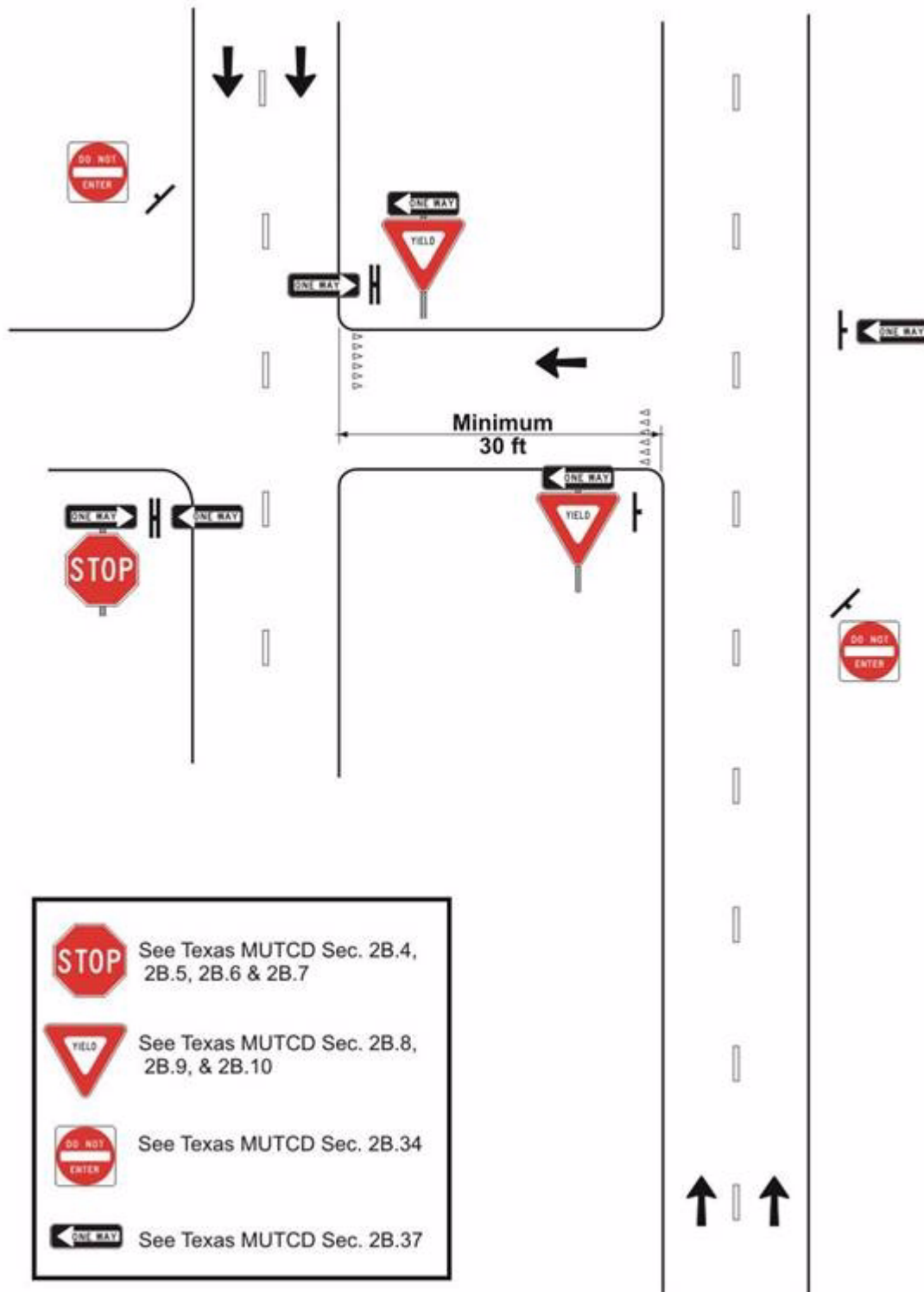

Figure 7-9. Signing for Wide Median Divided Highway Intersection with Local Road



**Crossovers**

Crossovers provide road users with an opportunity to change directions on a divided highway. There are no external roads at a crossover. This section presents the following crossover illustrations:

- ◆ Figure 7-10: Wide median crossover with left turn bays.
- ◆ Figure 7-11: Wide median crossover with no left turn bays.
- ◆ Figure 7-12: Narrow median crossover with left turn bays.
- ◆ Figure 7-13: Narrow median crossover with no left turn bays.

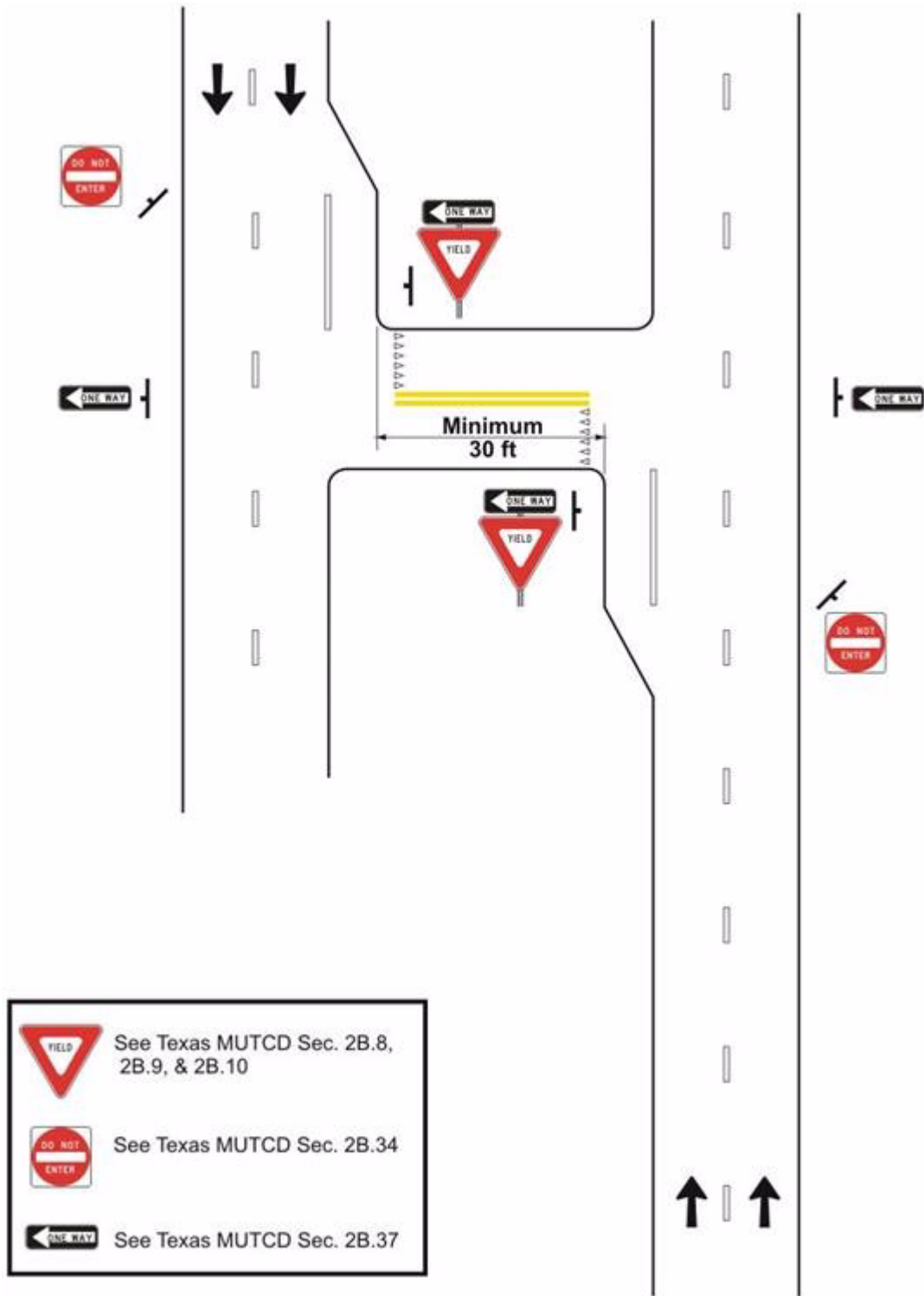

Figure 7-10. Signing for Wide Median Crossover with Left Turn Bay

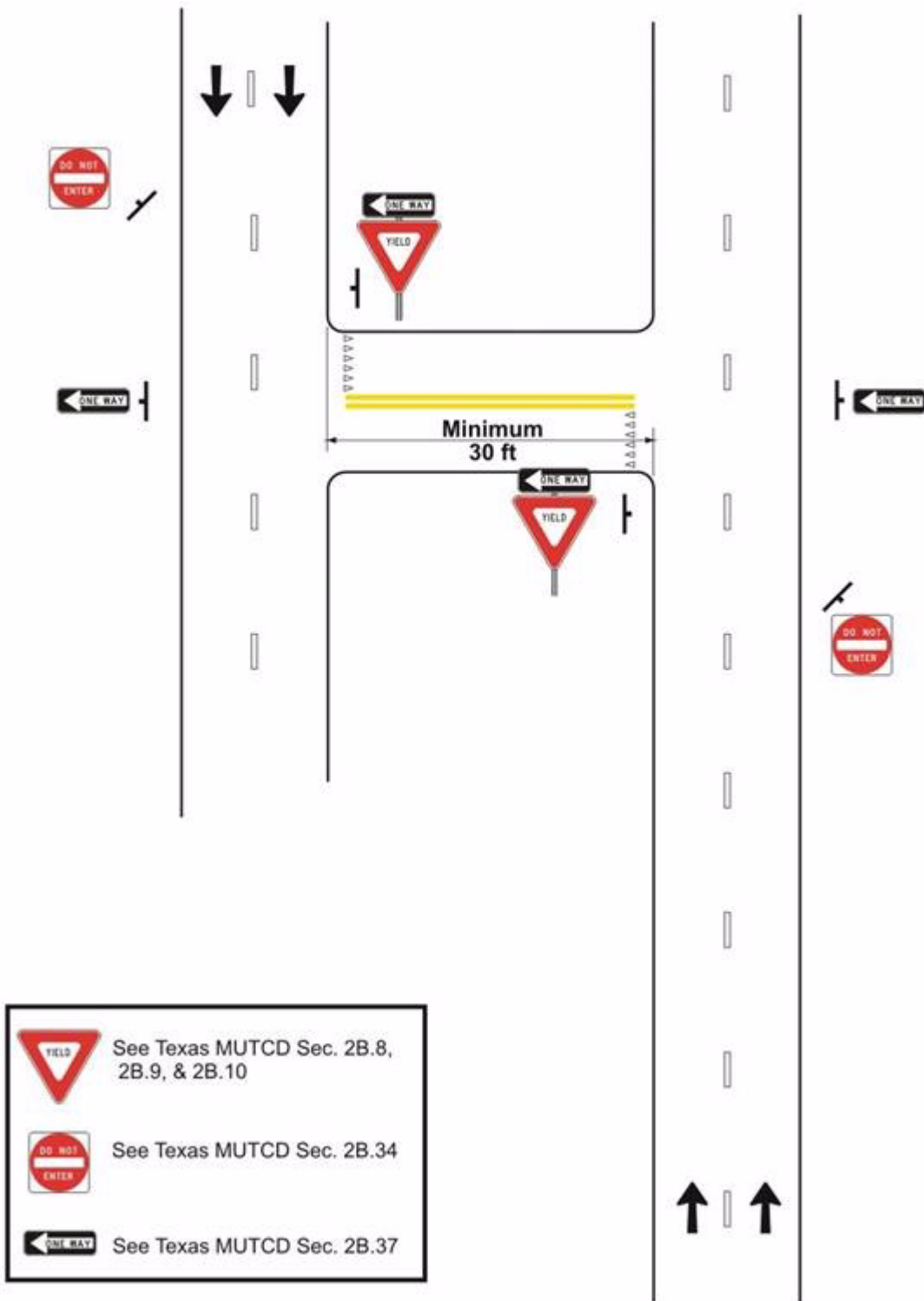

Figure 7-11. Signing for Wide Median Crossover without Turn Bay

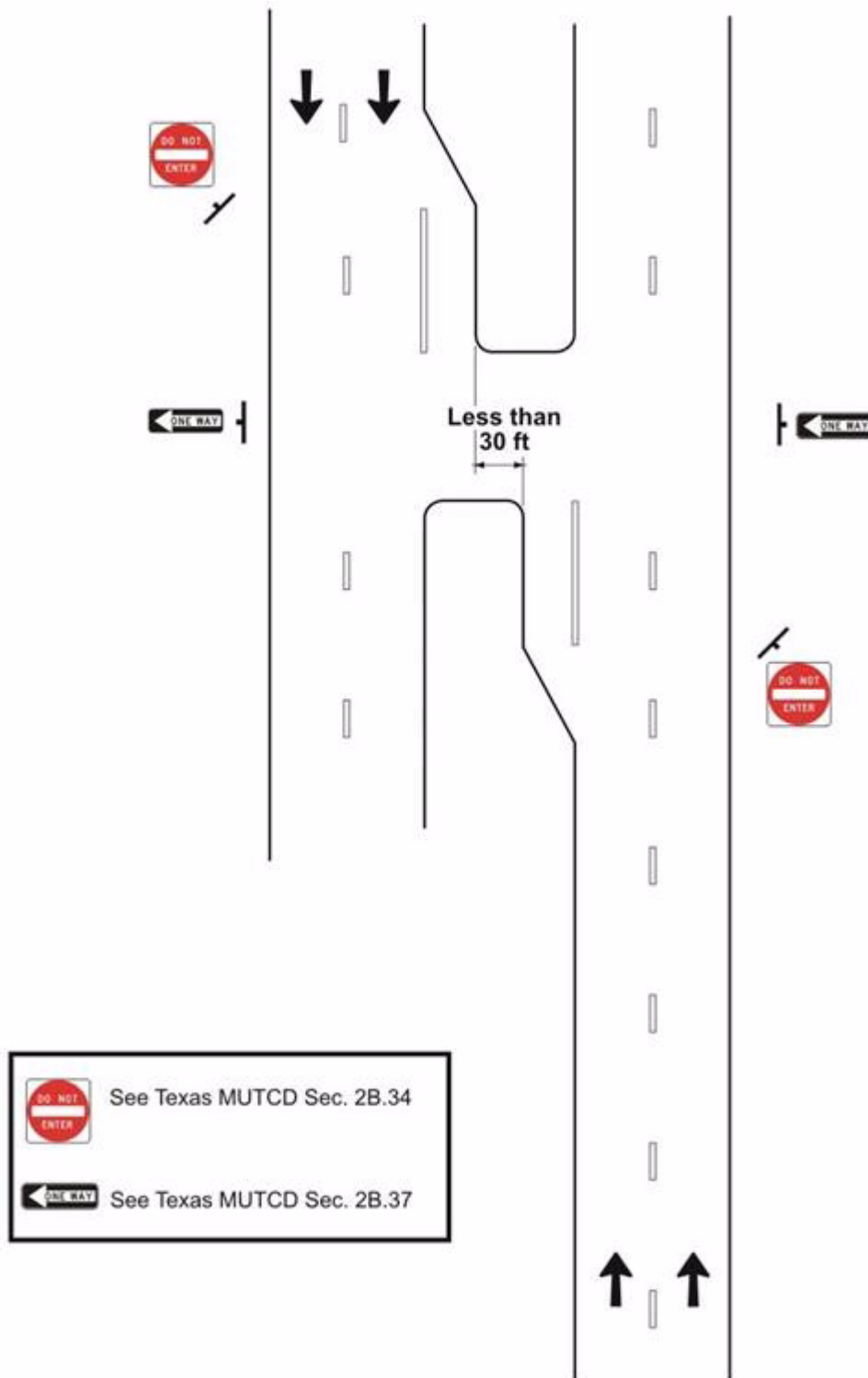

Figure 7-12. Signing for Narrow Median Crossover with Left Turn Bay

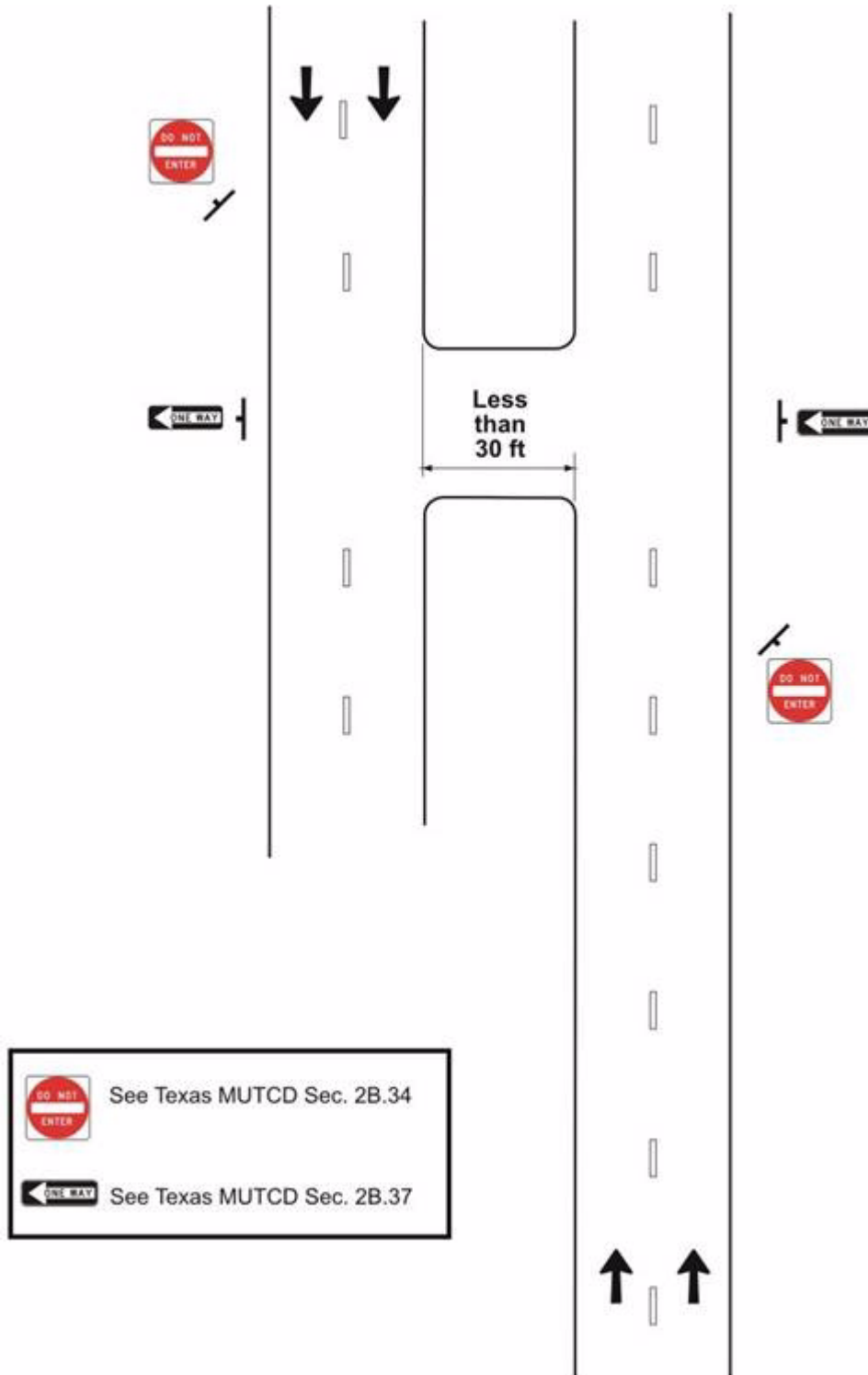

Figure 7-13. Signing for Narrow Median Crossover without Turn Bay

## Section 3

### Overlapping Routes

#### Introduction

In some cases, a roadway will have two T intersections that are separated by a distance of a few hundred feet. This condition is referred to as offset intersections. This configuration makes the signing on the through roadway more difficult due to the overlapping routes and basic geometric configuration. Figure 7-14 illustrates sign placement for this situation.

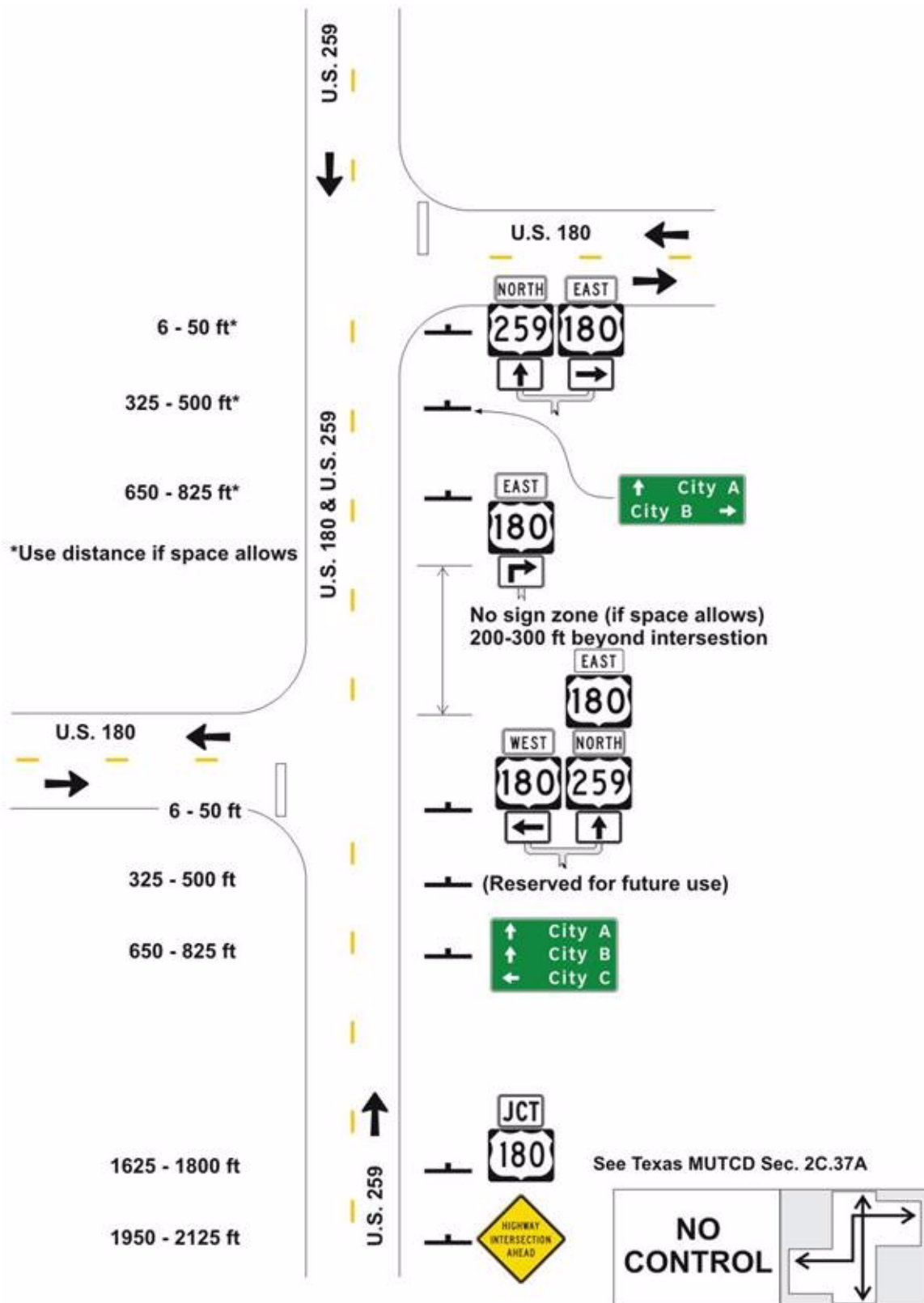

Figure 7-14. Signing for Offset Side T Intersections with Overlapping Routes

## **Section 4**

### **Road Ends**

#### **Introduction**

Some signing situations for conventional highways are not covered in other chapters of this field book. This section covers special applications where a road ends.

#### **Road Ends Situation**

Sign placement for the termination of a highway on the state system is illustrated in Figure 7-15. These signs include advanced warning (Dead End or No Outlet) located at the intersection of the terminating road with a non-terminating road, advance warning (Road Ends) located upstream of the actual end of the roadway, and a Type III barricade located at the actual end of the roadway with Type 4 End of Road markers on the barricade.



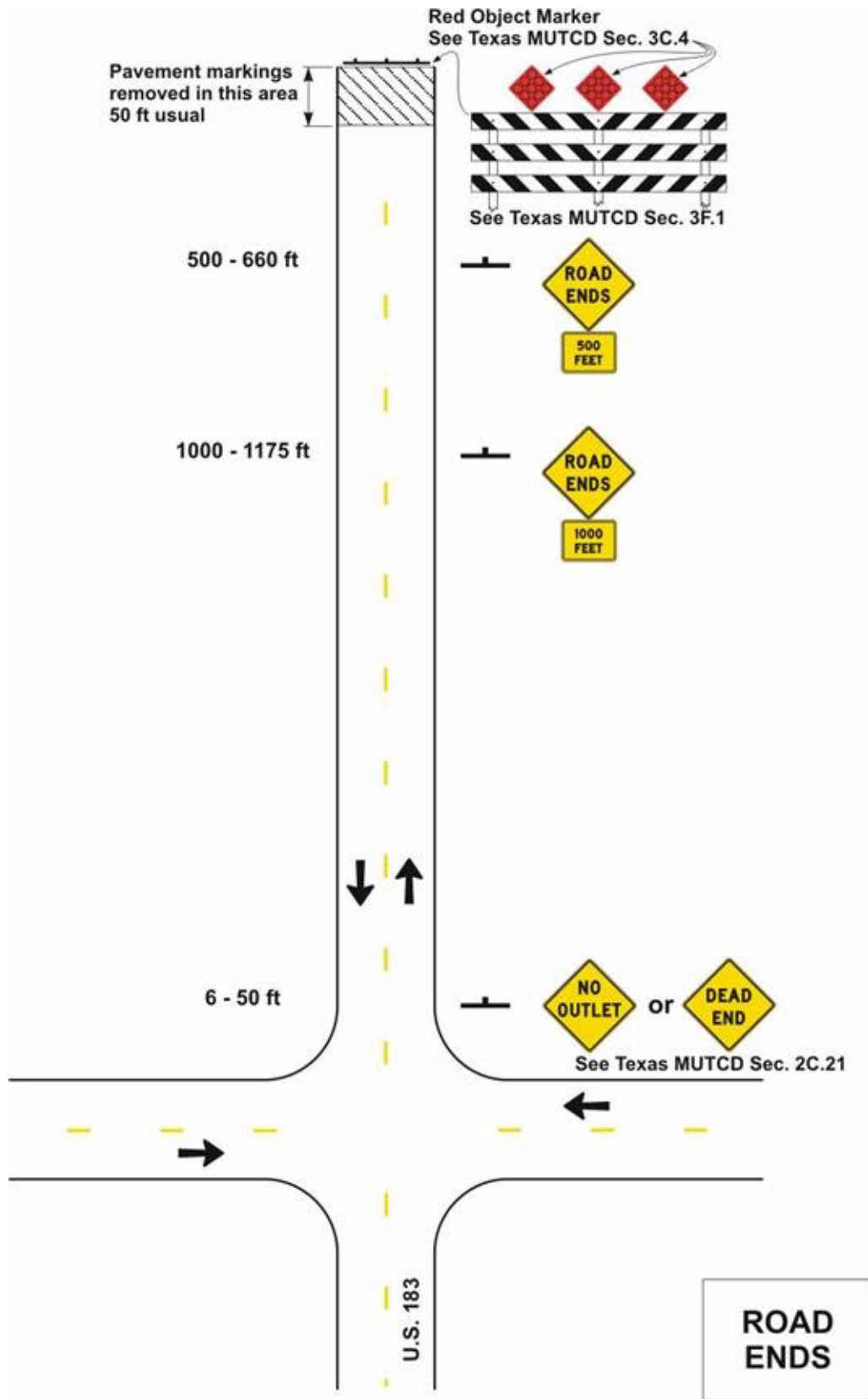

Figure 7-15. Road Ends Signing

## Section 5

### Interchange Applications

#### Introduction

In some situations, signing for a conventional highway is located at grade-separated interchanges or the ramps and frontage roads of freeways. This section addresses the unique signing applications of these situations.

#### Interchanges

Signing situations for grade-separated interchange off-ramps, on-ramps, gore areas, and streets approaching the interchange are illustrated in Figures 7-16 through 7-18. This section covers both Stop and Yield sign controlled ramps.

#### Frontage Roads

Frontage road signing issues for both the one-way and two-way frontage roads and their on- and off-ramps are addressed in this subsection. Figures 7-19 through 7-21 illustrate the placement of the signing on the frontage road and the intersection of the frontage road or ramp with a conventional highway.

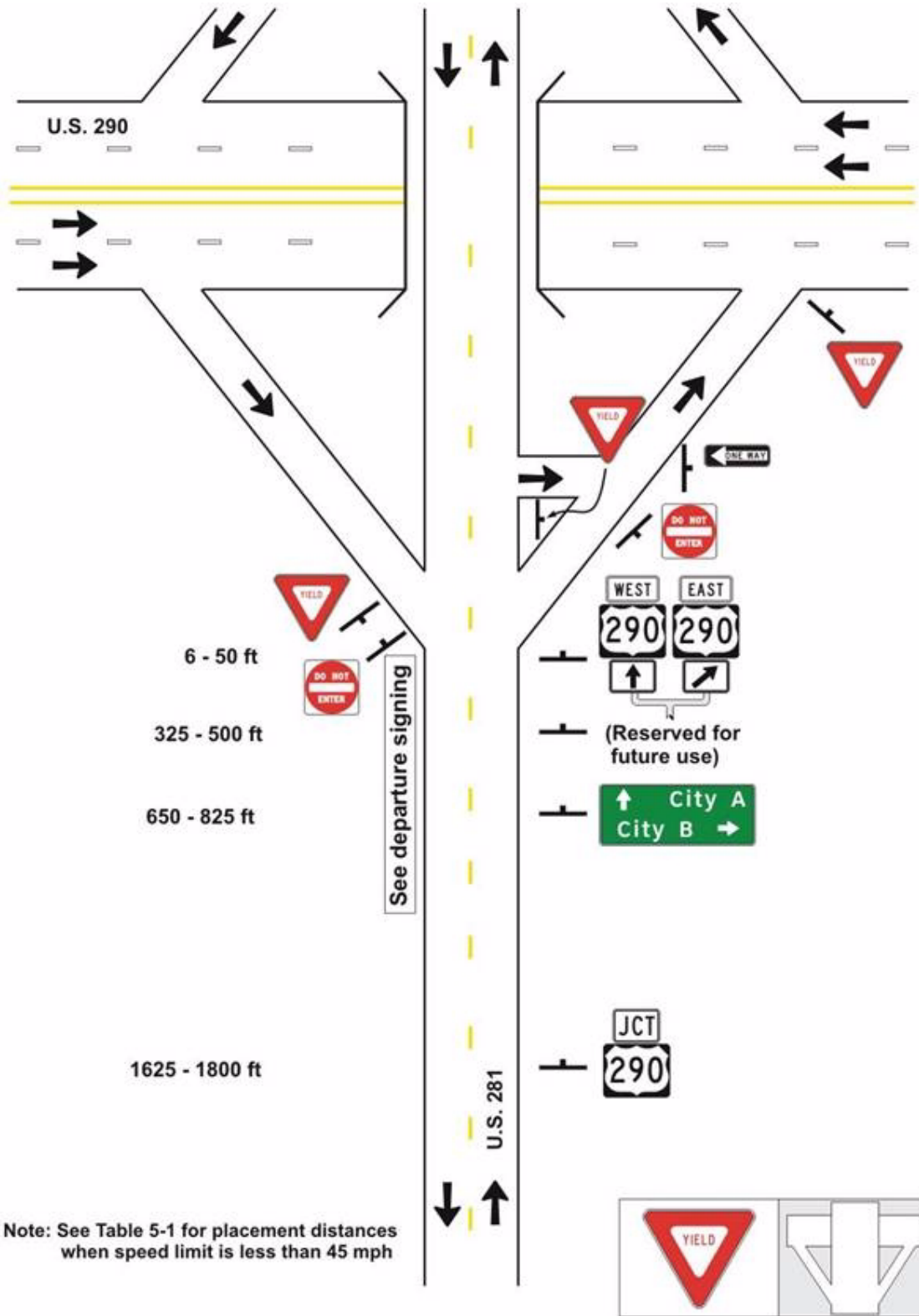

Figure 7-16. Interchange Approach, 1 Lane Approach, Yield Ramp Control, Approach Route Goes Through

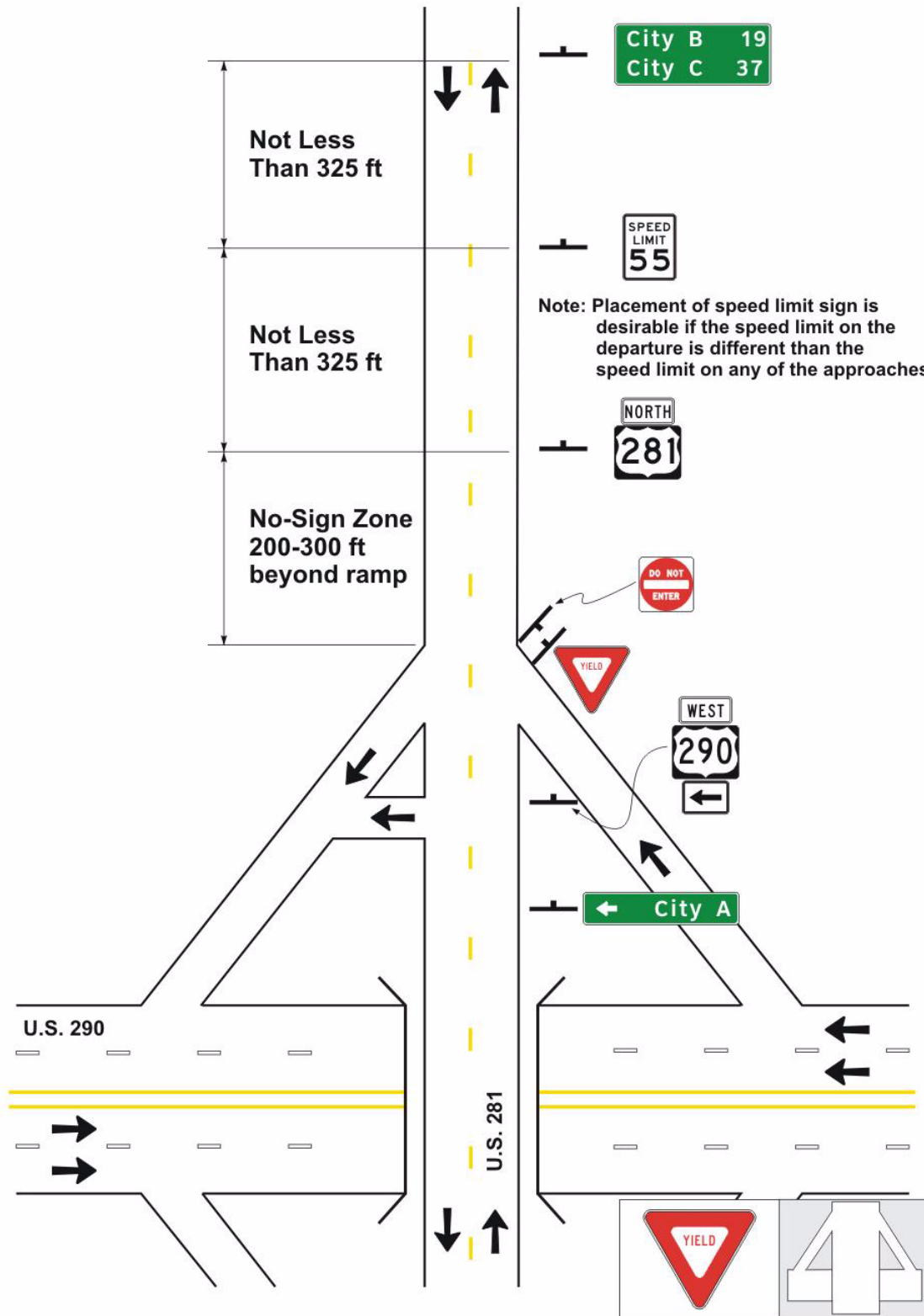

Figure 7-17. Interchange Departure, 1 Lane Approach, Yield Ramp Control, Approach Route Goes Through

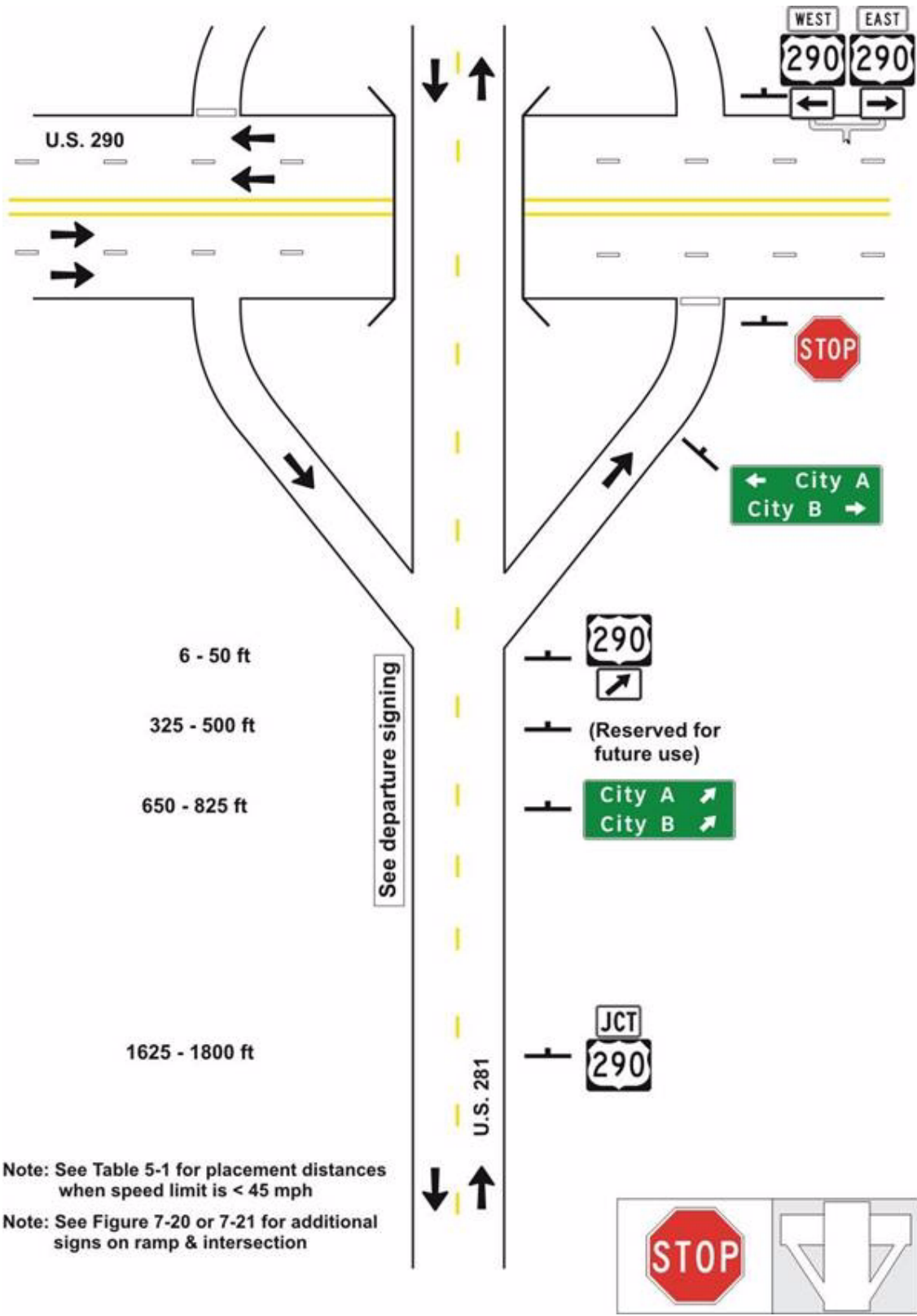

Figure 7-18. Interchange Approach, 1 Lane Approach, Stop Ramp Control, Approach Route Goes Through

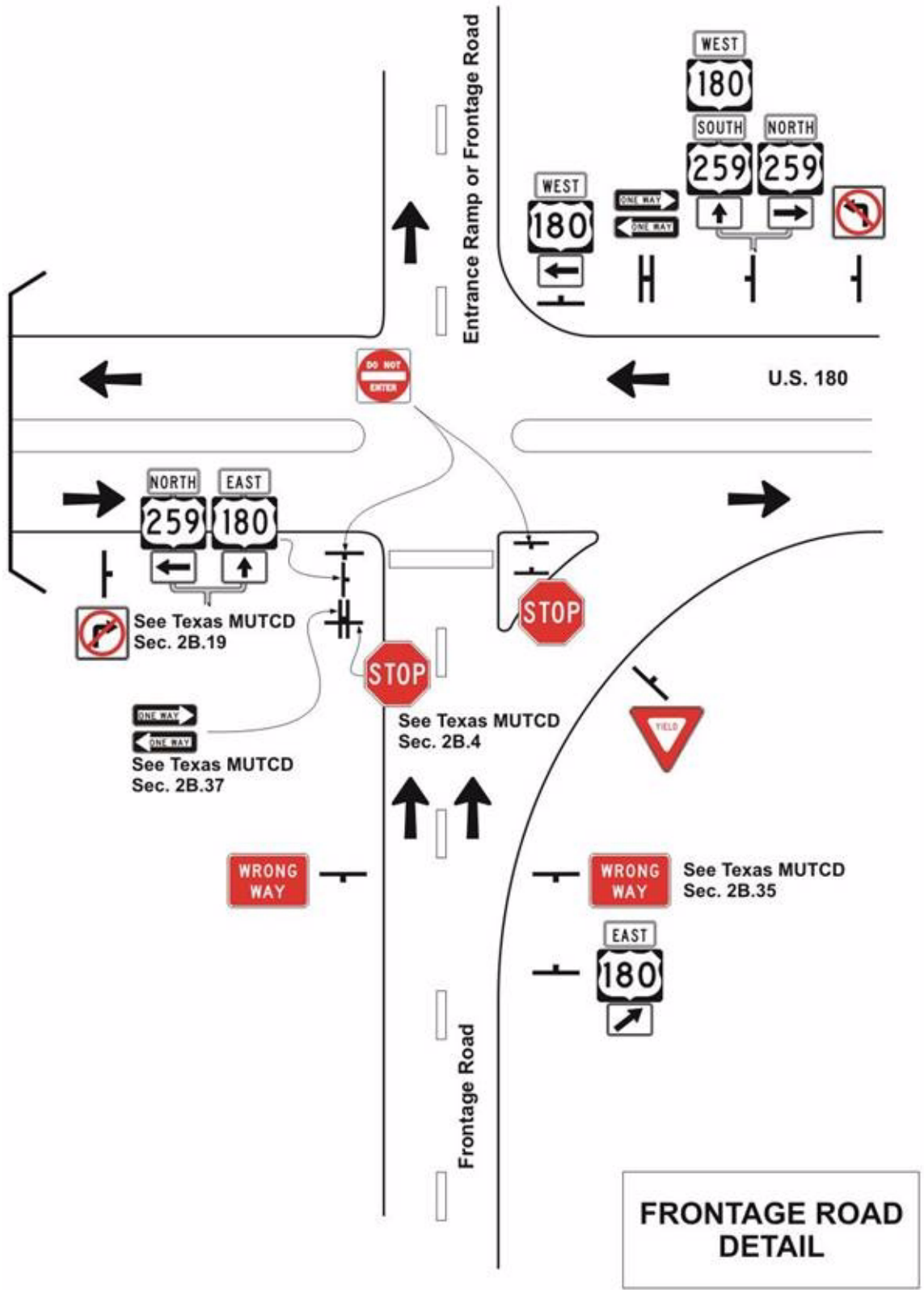

Figure 7-19. One-Way Frontage Road Intersection Area Detail

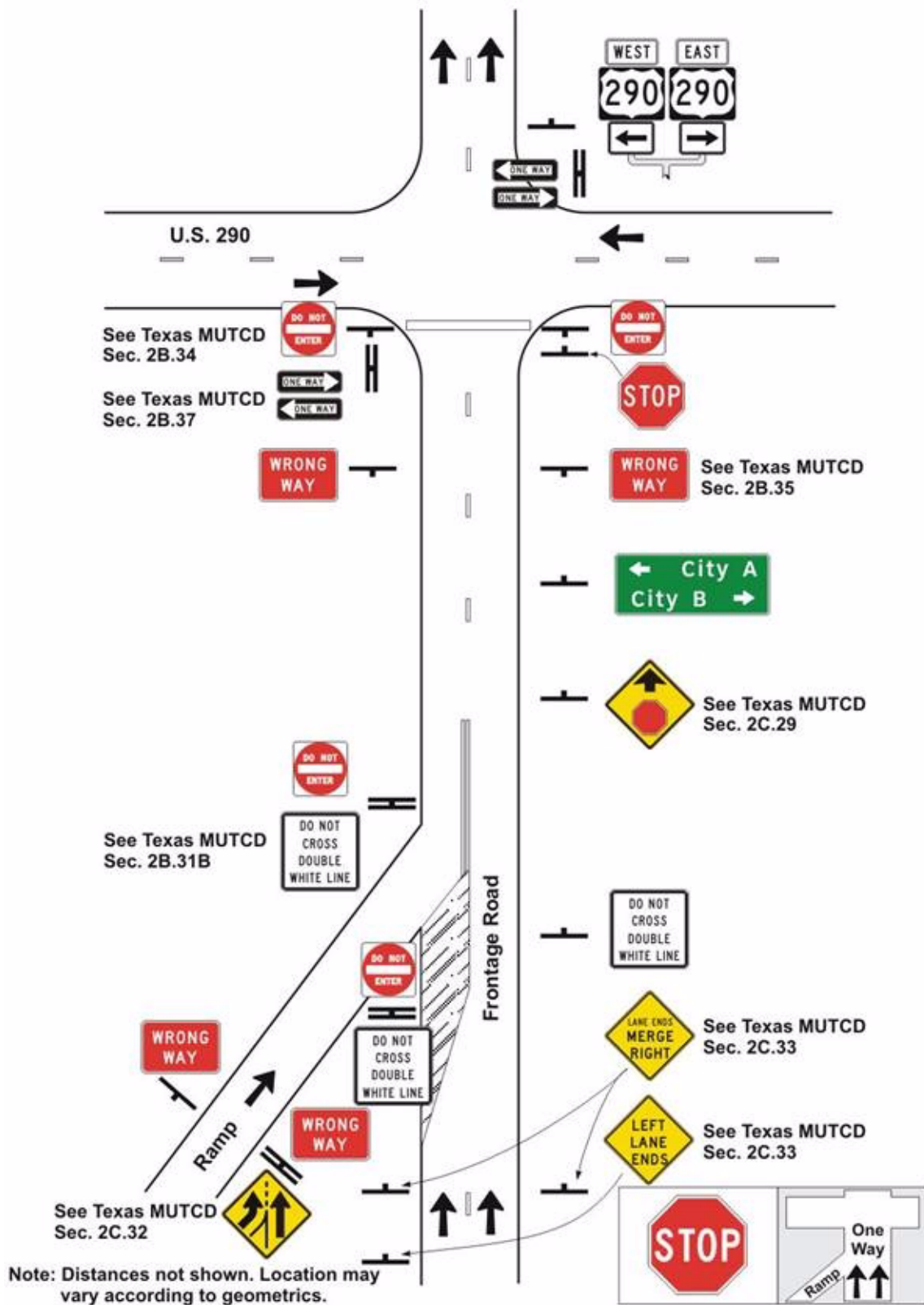

Figure 7-20. One-Way Frontage Road with Exit Ramp, 2 Lane Approach, Stop Control

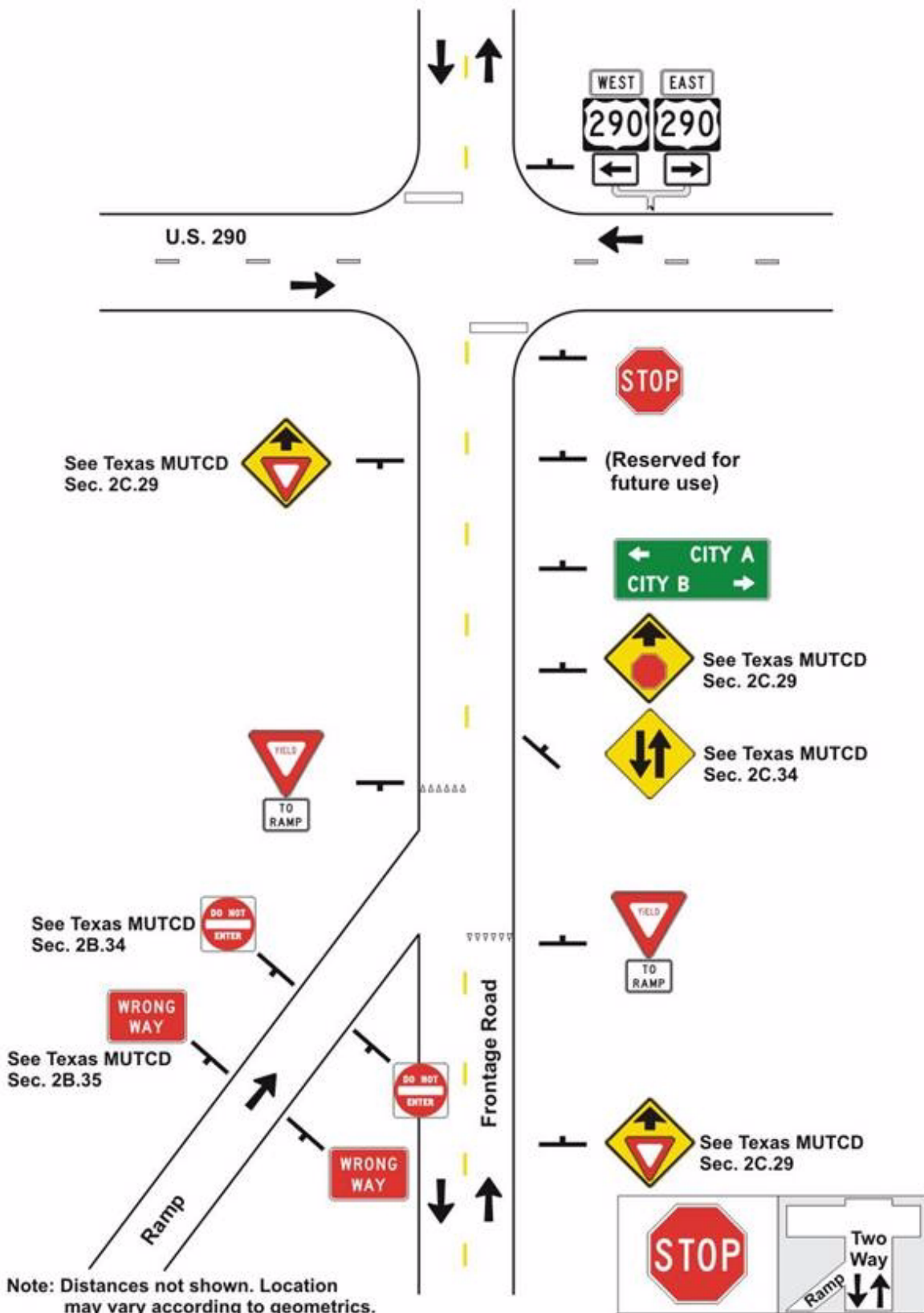

Figure 7-21. Two-Way Frontage Road with Exit Ramp, 1 Lane Approach, Stop Control



## **Section 6**

### **Lane Drop Applications**

#### **Lane Drop at No Control Intersections**

Figure 7-22 indicates the placement for signing at an intersection approach with no control where there is a lane drop on the through highway.

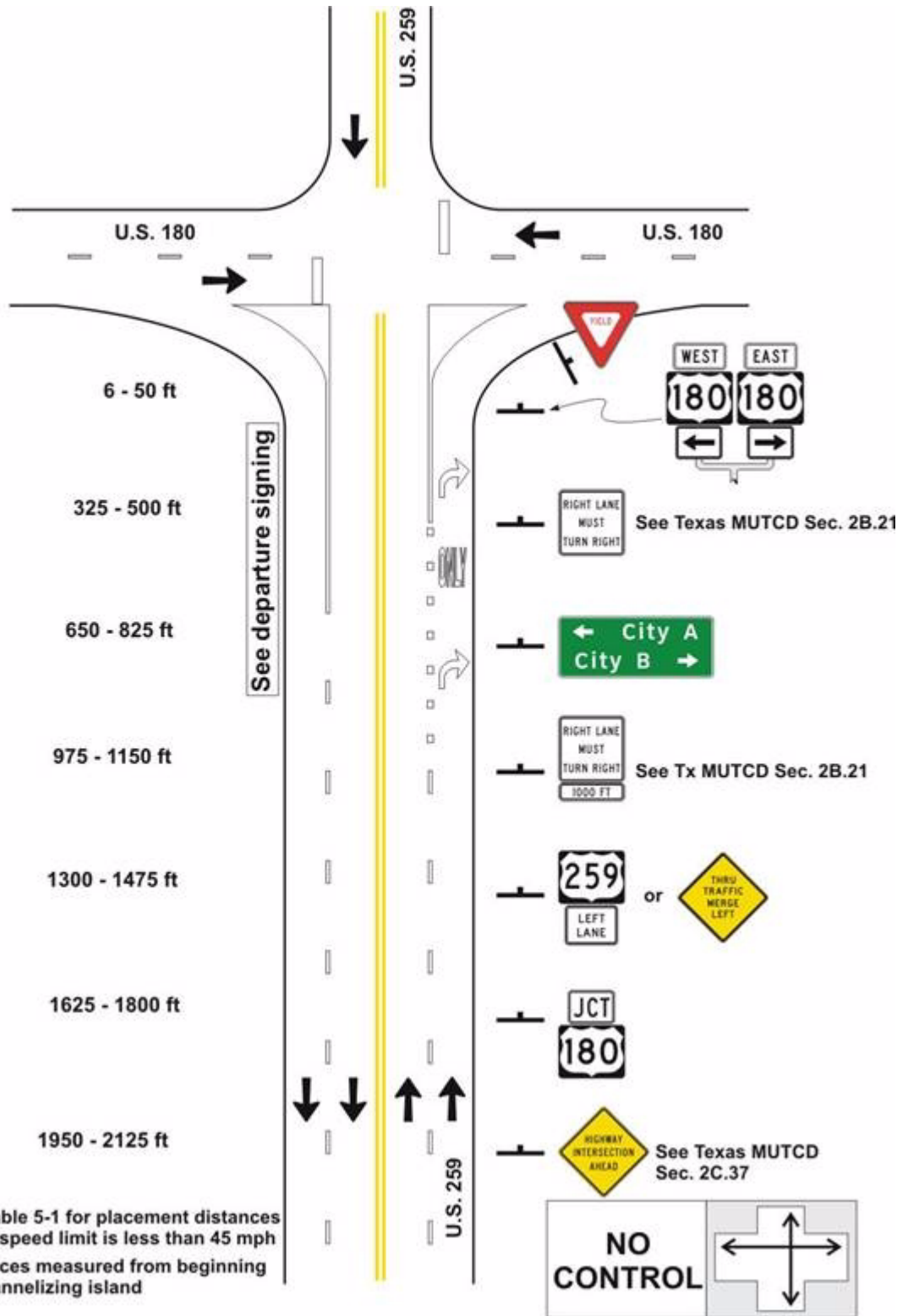

Figure 7-22. Lane Drop at Intersection

# Chapter 8

## Roadside Markers

### Contents:

[Section 1 — Overview](#)

[Section 2 — Object Markers](#)

[Section 3 — Delineators](#)

[Section 4 — Barrier Reflectors](#)

[Section 5 — Applications](#)

## **Section 1**

### **Overview**

#### **Introduction**

Roadside markers consist of object markers, delineators, and barrier reflectors. They are intended to provide motorists recognition and guidance information about roadside features. Each type of roadside marker has a particular use but all provide guidance to drivers when roadway conditions necessitate additional guidance above and beyond pavement marking capabilities. Typical features where roadside markers are usually provided include horizontal curves, bridges, guardrail, exit and entrance ramps to controlled access facilities, and the like. Roadside markers can be used for a wide variety of conditions and must be considered for each specific situation. Consequently, there are many different roadside marker applications for the various conditions along Texas roadways.

This chapter has been developed to provide the user basic concepts as well as general roadside marker treatments. The general design and use of object markers, delineators, and barrier reflectors are presented as well as generic treatments of each. The actual number of different treatments is potentially endless and therefore, only the most common treatments are supplied as examples. Additional information is also provided so that proper roadside marker treatments can be implemented in practically any situation.

## Section 2

### Object Markers

#### Introduction

Object markers use retroreflective material to indicate to the driver the presence of an object or obstruction within or adjacent to the roadway. In addition to marking the object or obstruction, some object markers also indicate the side to which a driver should pass. Typical obstructions where object markers may be used include bridge ends, guardrail end treatments, culvert headwalls, and other obstructions within the right-of-way.

---

**Types of Object Markers (Texas MUTCD, Section 3C.01)**

There are three types of object markers as described below and illustrated in Figure 8-1.

- ◆ **Type 1 Object Marker:** A yellow diamond-shaped panel consisting of all retroreflective sheeting (OM1-3).
  - The minimum size of the OM-1 is 18 x 18 inches.
  - The bottom of a Type 1 object maker is located at least 4 ft above the edge of the travel lane.
- ◆ **Type 2 Object Marker:** A yellow rectangle or series of three yellow reflectors.
  - OM2-1: A series of three yellow retroreflectors.
  - OM2-2: A yellow rectangular panel consisting of all retroreflective sheeting. The minimum size of the panel is 6 x 12 inches.
  - The Type 2 object marker is mounted with a vertical orientation.
  - The bottom of a Type 2 object marker is mounted at a height of at least 4 ft. If the object marker is within 8 ft of the edge of the travel lane, the mounting height is above the edge of the travel lane. When the object marker is more than 8 ft from the edge of the travel lane, the mounting height is above the ground. Higher or lower mounting heights can be used according to need.
- ◆ **Type 3 Object Marker:** A vertical rectangle with black and yellow diagonal stripes.
  - OM-3L: An object marker with diagonal stripes oriented from the top left to lower right. The OM-3L is located on the left side of the road.
  - OM-3C: An object marker with diagonal stripes oriented from the center downward to the left and right. The OM-3C is located in the roadway when vehicles can pass on both sides of the object marker.
  - OM-3R: An object marker with diagonal stripes oriented from the top right to lower left. The OM-3R is located on the right side of the road.
  - All versions of the Type 3 object marker have a minimum size of 12 x 36 inches.
  - The bottom of a Type 3 object marker is located at least 4 ft above the edge of the travel lane.

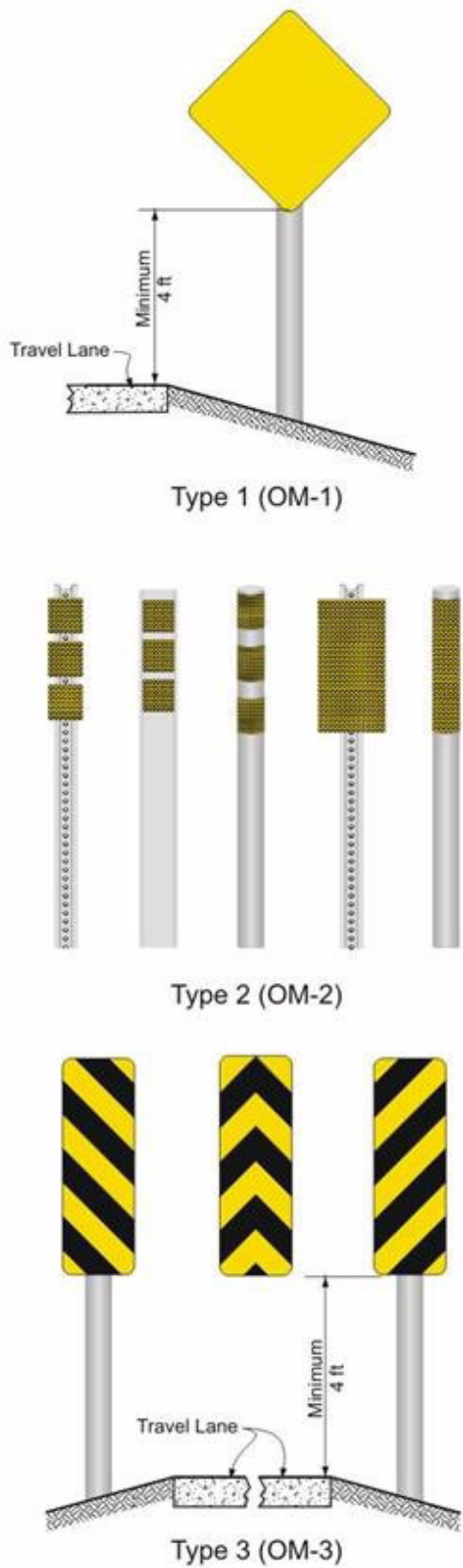

Figure 8-1. Object Markers

**End of Roadway Marker (Texas MUTCD, Section 3C.04)**

The end-of-roadway marker has the same appearance as a Type 1 object marker except that it uses red retroreflective sheeting instead of yellow. End-of-roadway markers are used to indicate the end of a roadway when there are no alternative paths. End-of-roadway markers are usually combined with a barricade (see Texas MUTCD Section 3F.01) to mark the end of a road.

**Omni-Directional Sign Post Wrap**

A sign post wrap consists of yellow or red retroreflective sheeting wrapped around a sign post to identify the support as a roadway object.

- ◆ Retroreflective sheeting wrapped around a sign is yellow unless the sign on the support is a Stop or Yield sign, in which case the sheeting is red.
- ◆ Retroreflective sheeting wrapped around a sign has a height on the post of at least 12 inches.
- ◆ The bottom of retroreflective sheeting wrapped around a sign is approximately 4 ft above the edge of the travel lane.



### Application of Object Markers (Texas MUTCD, Section 3C.02 and 3C.03)

Figures 8-2 and 8-3 show how guardrail end treatments are marked with object markers. Note that when the energy absorbing treatment is used, a post mounted object marker is not required if a guardrail end treatment object marker is built into the side of the treatment facing traffic.

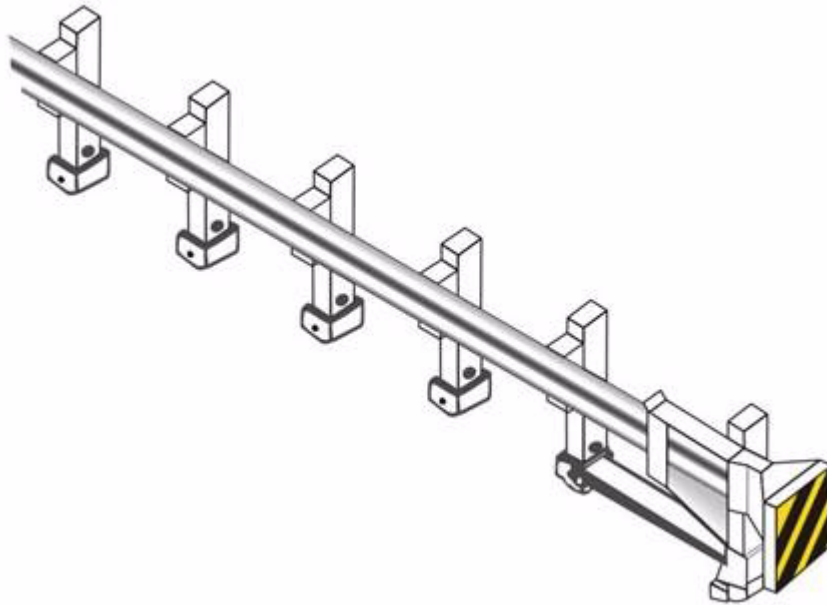

Figure 8-2. Object Marker at Energy Absorbing Treatment (EAT)

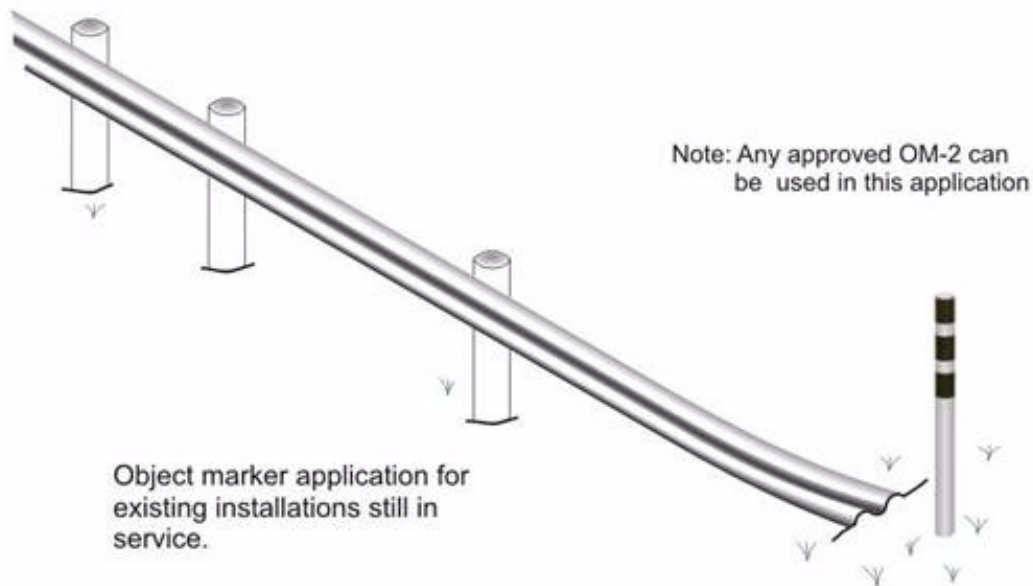

Figure 8-3. Object Marker at Turndown (Texas Twist)

---

## Section 3

### Delineators

#### Introduction

Road delineators are retroreflective guidance devices mounted near the edge of a roadway to indicate the roadway alignment. They are typically used when changes in horizontal alignment or pavement width transitions exist. Delineators are effective aids for night driving and when either rain or snow limits the effectiveness of pavement markings.

#### Delineator Design (Texas MUTCD, Section 3D.02)

Delineators consist of retroreflective material with a minimum dimension of 2.75 inches. Figure 8-4 indicates various delineator designs.



Figure 8-4. Delineators

**Delineator Application (Texas MUTCD, Section 3D.03)**

Table 8-1 indicates the various uses for delineators for different types of roadways and roadway situations.

**Table 8-1: Uses of Delineators**

Type of Road or Condition		Condition for Use				Delineator Spacing
		Required (shall be used)	Recommended (should be used)	Optional (may be used)	Prohibited (cannot be used)	
Freeways or Expressways	Straight	D-SW on right or raised pavement				200-530 ft
	Curve	D-SW on right				See Table 8-2
	Ramp	D-SW (right) or D-SY (left) on one side	On outside of interchange ramp curves			
Other than Freeways or Expressways	Straight			D-SW on right or left side	D-SY on left side of two-way roads	200-530 ft
	Curve					See Table 8-2
Acceleration and Deceleration Lanes			D-DW or D-DY			100 ft spacing
Wrong-way				D-SR for wrong-way traffic		
Pavement Narrowing (lane merge)				D-SW (right) or D-SY (left) adjacent to lane for full affected length of transition		
Truck Escape Ramps			D-SR on both sides of ramp			50 ft spacing
<p>Notes:</p> <p>Unless indicated otherwise, the color of delineators must conform to the color of the pavement edge line on the edge line of the side of the road where the delineators are placed.</p> <p>See Table 8-2 for delineator and barrier marker spacing on curves and the approaches to curves.</p> <p>Barrier markers cannot be used to replace required delineators.</p> <p>D-SR can be mounted on the back side of existing delineator posts.</p>						

## Delineator Placement

Typically, the height of delineators is 4-5 ft above the edge of the travel lane. Delineators are located 2-8 ft from the edge of the pavement. All delineators on a stretch of highway should be the same distance from the edge of the pavement, except where a restriction exists (such as guardrail, culvert headway, or other obstruction). Where a restriction exists, the delineators should be in line with the inner most edge of the obstruction. Figure 8-5 depicts typical delineator placement.

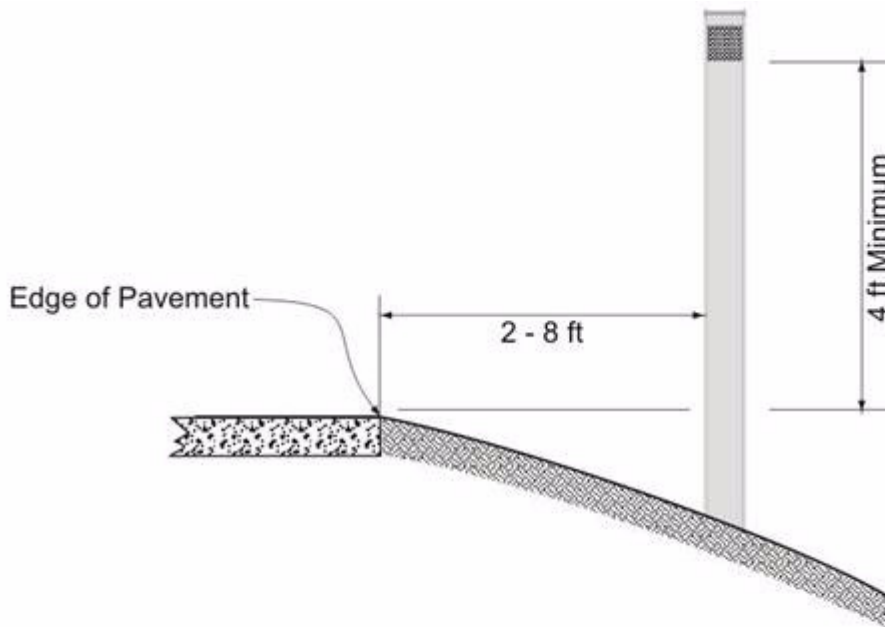

**Notes:** All delineators on a section of roadway should be placed the same distance from the edge of pavement. Where a restriction prevents consistent placement from the pavement, the affected delineators should be placed in line with the innermost edge of the obstruction.

When delineators are more than 8 ft from the edge of the pavement, it may not be possible to maintain a minimum height of 4.0 ft. If this is the case, the delineators should be placed as close to the desired height as possible.

*Figure 8-5. Typical Delineator Installation*

When delineators are installed further than 8 ft from the edge of the pavement, it may not be practical to provide a height of 4-5 ft. In this case, the delineator is installed so the reflective unit is as close to 4.0-4.5 ft above the surface of the pavement edge as practical.

Delineators may be attached to a vertical support. An example includes along guardrail posts. Figure 8-6 illustrates examples of delineators attached to guardrail posts.

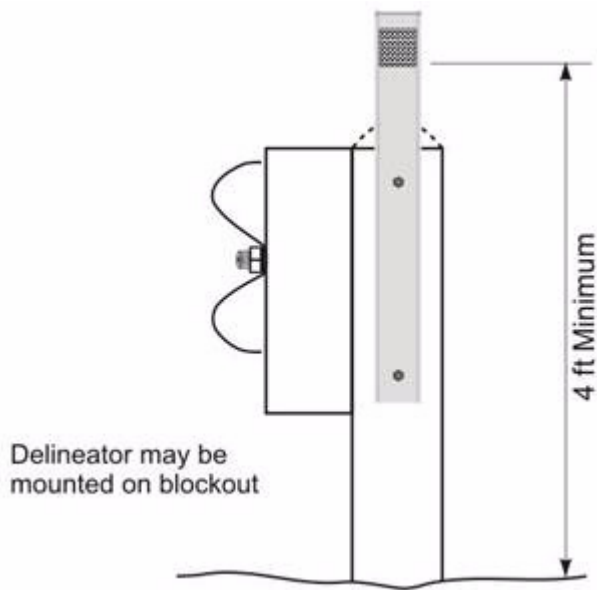

Figure 8-6. Delineator Installation on Guardrail Post

### Delineation Spacing

Spacing for delineators depends on the application. Single delineators installed anywhere except along a curve or roadside barrier should be uniformly spaced 200 to 528 ft. However, when a driveway or intersection interrupts the selected spacing interval, that delineator should be located as close to its correct position without interfering with the driveway or intersection.

- ◆ Horizontal Curves - On horizontal curves, delineator spacing should be adjusted so that several delineators are always visible to the driver. Tables 8-2 and 8-3 illustrate spacing for delineators on horizontal curves as well as on approaches and departures from horizontal curves. The minimum spacing is 20 ft, and the maximum is 300 ft.
- ◆ Roadside Barriers - When delineators are used in conjunction with roadside barriers (i.e., guardrail, bridge rail, or concrete barrier) on straight sections of roadway, the spacing should be adjusted to ensure a minimum of three delineators are used, with a maximum spacing of 100 ft between any two delineators. When the roadside barrier is located along a curved section, Table 8-2 or 8-3 should be used to determine the appropriate delineator spacing up to a maximum of 100 ft. Section 4 should be used for applications concerning concrete median barriers.

Other types of retroreflective devices may be used on sections of roadways with guardrail, bridge rail, or concrete barrier. See Section 4 for more information.

**Table 8-2: Suggested Spacing for Highway Delineators on Horizontal Curves Based on Degree of Curve**

Degree of Curve	Radius of Curve, ft	Spacing in Curve (A), ft
0.5	11460	300
1	5730	225
2	2865	160
3	1910	130
4	1433	110
5	1146	100
6	955	90
7	819	85
8	716	75
9	637	75
10	573	70
11	521	65
12	478	60
13	441	60
14	409	55
15	382	55
16	358	55
19	302	50
23	249	40
29	198	35
38	151	30
57	101	20

Notes: when delineators are used on curves with a barrier, the maximum spacing between any 2 delineators is 100 ft

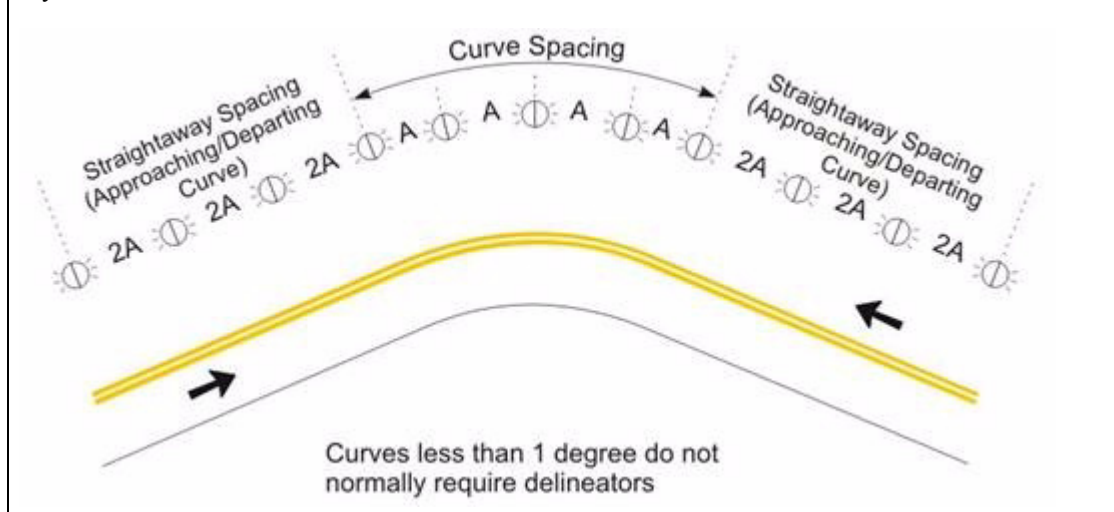

**Table 8-3: Suggested Spacing for Highway Delineators on Horizontal Curves Based on Advisory Speed**

Advisory Speed (mph)	Spacing in Curve (A), ft
65	130
60	110
55	100
50	85
45	75
40	70
35	60
30	55
25	50
20	40
15	35

Notes: when delineators are used on curves with a barrier, the maximum spacing between any 2 delineators is 100 ft

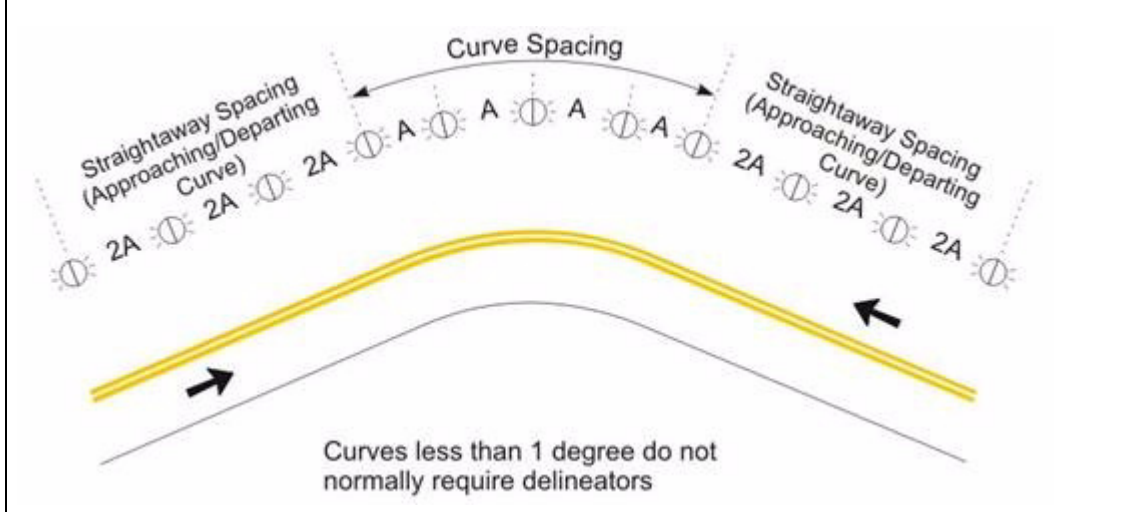

### Delineation for Divided Highway Intersections and Crossovers

The following delineation is typically used for divided highway intersections and crossovers:

- ◆ With left turn bay on approach: Use retroreflective raised pavement markers (RRPMs) to supplement the solid left turn lane line. Figure 8-7 illustrates this application. The RRPMs are placed 4 inches inside the left turn lane line and at 10 ft spacing. Use a Type II-C-R RRPM.
- ◆ With no left turn bay on approach: Use Type 2 object marker on near side and far side of median opening. Figure 8-8 illustrates this application.

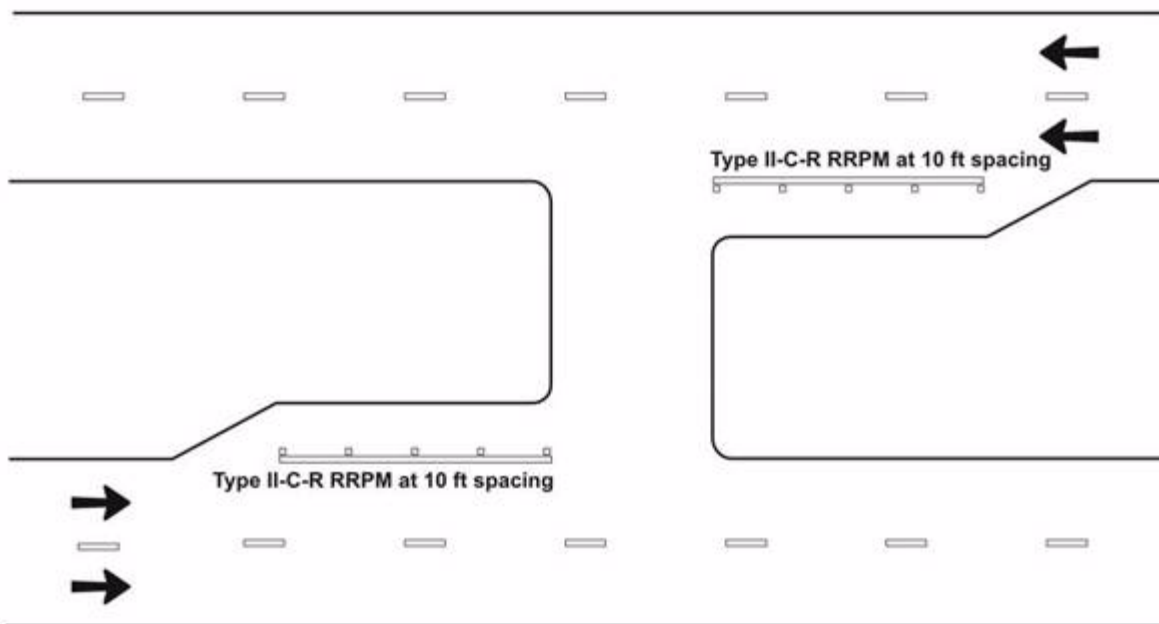

Figure 8-7. Delineation for Median Opening with Left Turn Lane on Approach

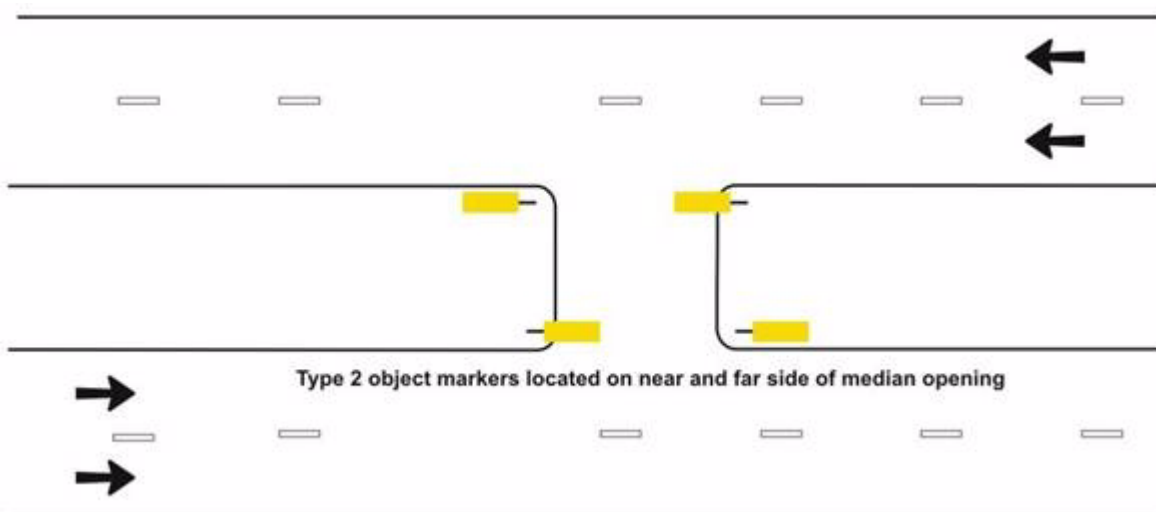

Figure 8-8. Delineation for Median Opening with No Left Turn Lane on Approach



## Section 4

### Barrier Reflectors

#### Introduction

Barrier reflectors (BR) are retroreflective devices used to inform motorists of the presence of a guardrail, bridge rail, or concrete barrier adjacent to the roadway during nighttime conditions.

#### Barrier Reflector Design

Various types of barrier reflectors may be used to mark guardrail, bridge rail, or concrete barrier. Figure 8-9 indicates some of these devices.

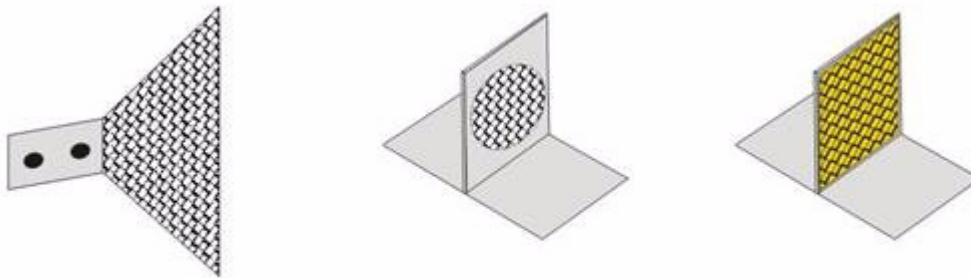

Note: Barrier reflectors available in white (BR-W) or yellow (BR-Y)

Figure 8-9. Barrier Reflectors

#### Barrier Reflector Application

Barrier reflectors are used on guardrail, bridge rail, or concrete barrier. If used, the following guidelines apply:

- ◆ Barrier reflectors do not replace required (shall) or recommended (should) delineation.
- ◆ Barrier reflectors can be used in place of optional (may) delineation.
- ◆ Barrier reflectors can be used in combination with delineators.
- ◆ Continuous bi-directional (two-way) barrier reflectors or delineation should be provided along roadside barriers for two-way roadways. For one-way and multilane roadways, barrier reflectors can be uni-directional (one-way).

### Barrier Reflector Placement

- ◆ If used, barrier reflectors should be placed in one of the following locations:
  - In the depressed center section of a W-beam guardrail (butterfly type retroreflective device, see Figure 8-10),
  - On top or on the side of concrete barrier (see Figure 8-10), or
  - On guardrail/bridge rail posts or blockouts.
- ◆ Barrier reflectors should be installed a minimum of 18 inches above the edge of the pavement surface. Consistent barrier reflector height along the barrier is desired.

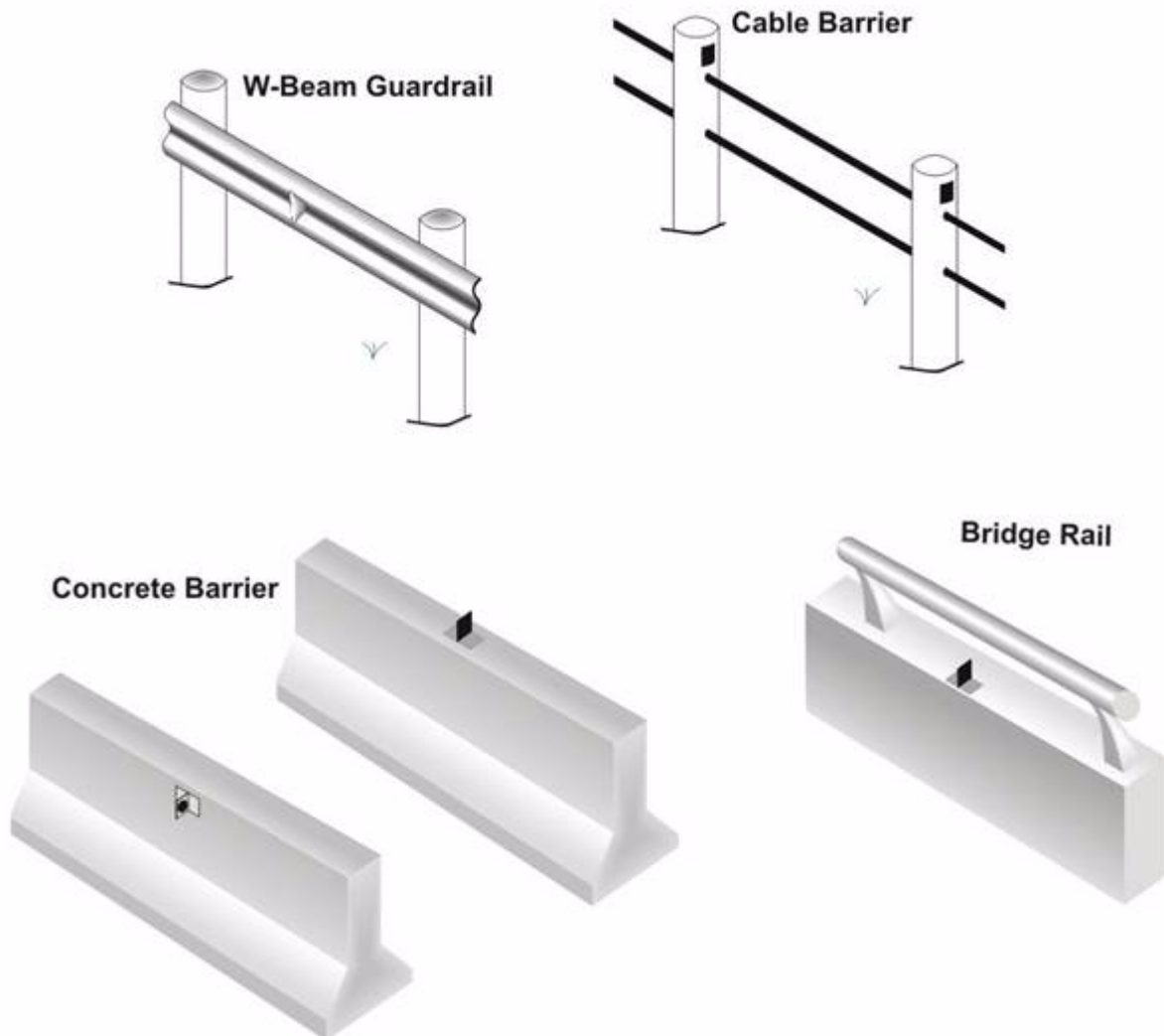

Figure 8-10. Typical Barrier Reflector Installation

### Barrier Reflector Spacing

When used on straight sections of roadway, the spacing between barrier reflectors should be adjusted to ensure a minimum of three barrier reflectors are used, with a maximum spacing of 100 ft between any two barrier reflectors. When barrier reflectors are used along a curved section, Table 8-2 should be used to determine the appropriate barrier reflector spacing up to a maximum of 100 ft. Barrier reflectors may not be used to replace delineators on freeway or expressway curves. Figure 8-11 illustrates barrier reflector spacing.

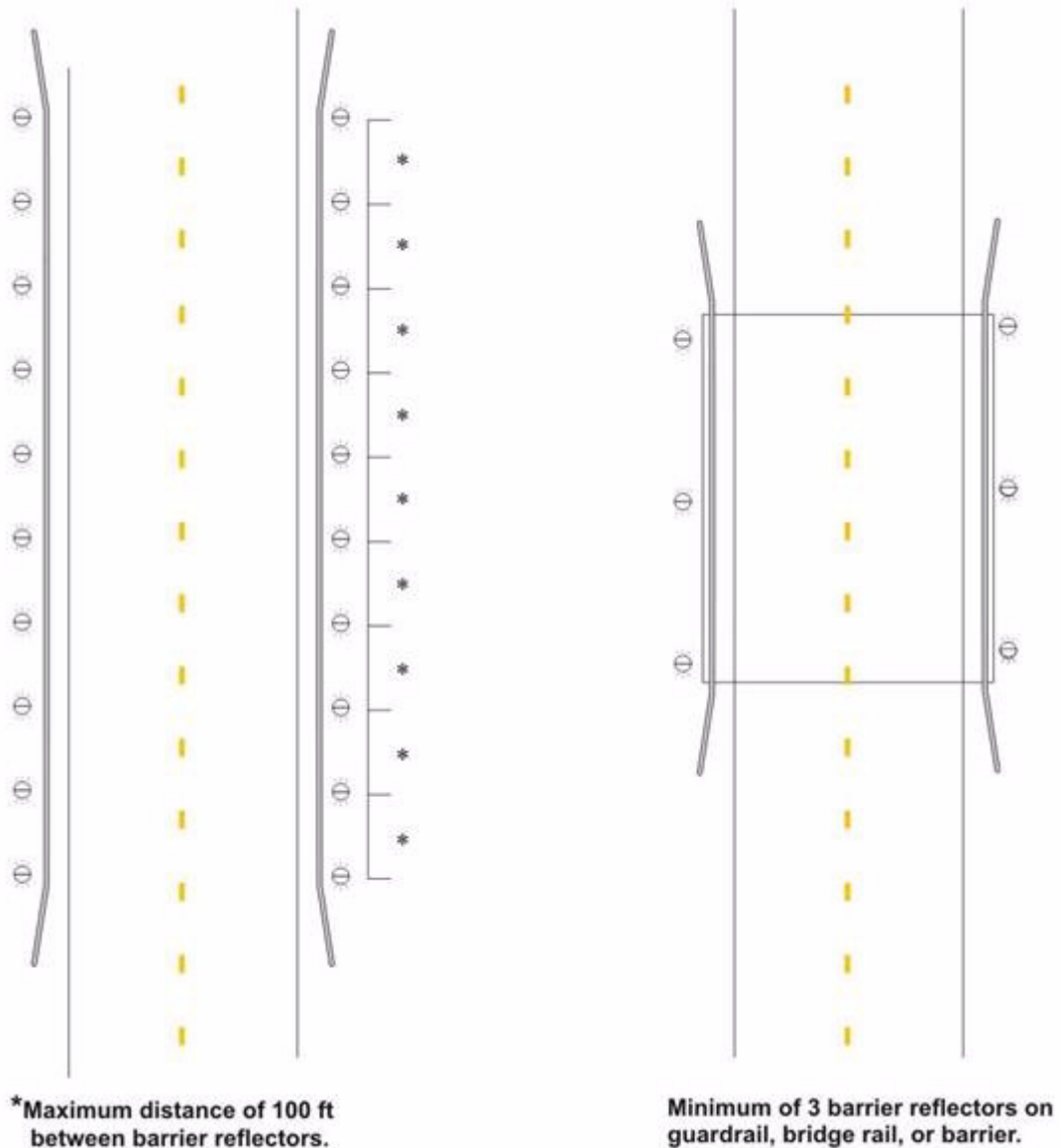

Figure 8-11. Barrier Reflector Spacing

## Section 5

### Applications

#### Introduction

This section provides examples of typical roadside marker treatments that may be encountered during day-to-day activities. The examples provided are intended to provide guidance and are not meant to be standards.

#### Application Illustrations

Figures 8-12 to 8-19 illustrate various uses of object markers, delineators, and barrier reflectors. This section presents the following examples:

- ◆ Figure 8-12: Two-way, two-lane road or bridge with guardrail and no change in approach width.
- ◆ Figure 8-13: Two-way, two-lane road or bridge with guardrail and reduced width approach.
- ◆ Figure 8-14: Two-way, two-lane bridge with no approach rail.
- ◆ Figure 8-15: Multi-lane undivided, two-way road or bridge with guardrail.
- ◆ Figure 8-16: One-way road or bridge (or divided highway) with guardrail.
- ◆ Figure 8-17: Two-way road over culvert.
- ◆ Figure 8-18: Freeway delineation.
- ◆ Figure 8-19: One-way ramp detail.

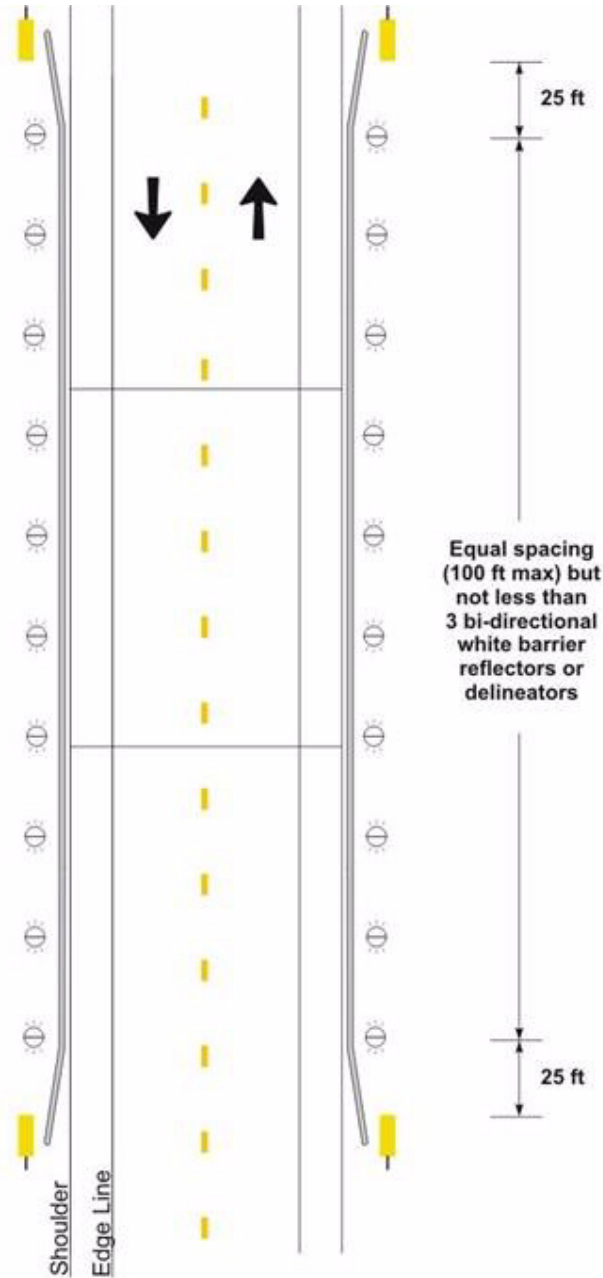

**Notes:**

- If used, there should be a minimum of 3 delineators or barrier reflectors, with a maximum spacing of 100 ft between any 2 delineators or barrier reflectors.
- First delineator or barrier reflector should be placed approximately 25 ft from guardrail approach end.
- Delineators or barrier reflectors should end where guardrail flares away from roadway.
- Delineators and barrier reflectors shall be bi-directional.

LEGEND	
	D-SW or BR-W
	OM-Type 2
For EAT end treatment see Figure 8-2	

Figure 8-12. Two-Way, Two-Lane Road or Bridge with Guardrail and No Change in Approach Width

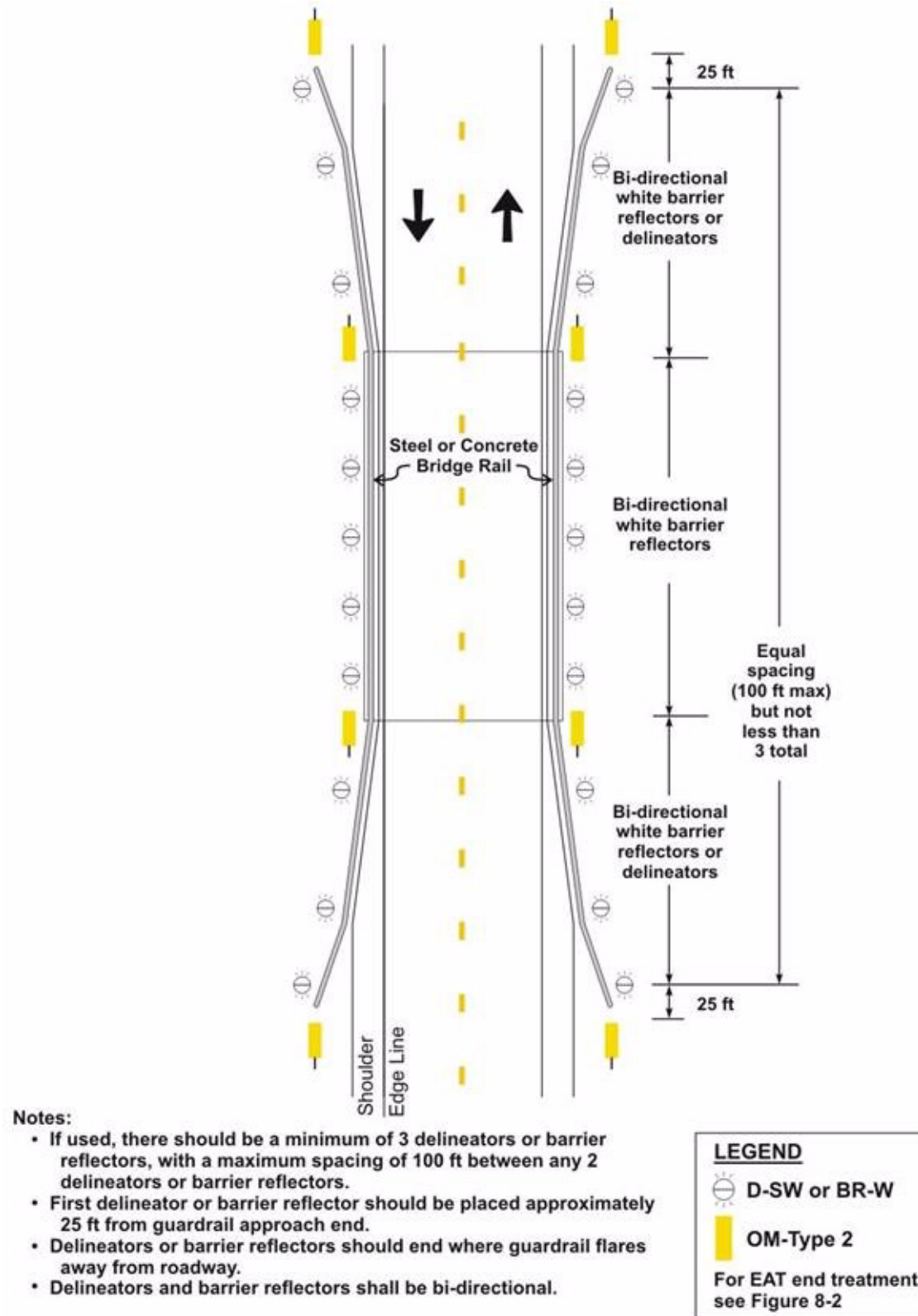
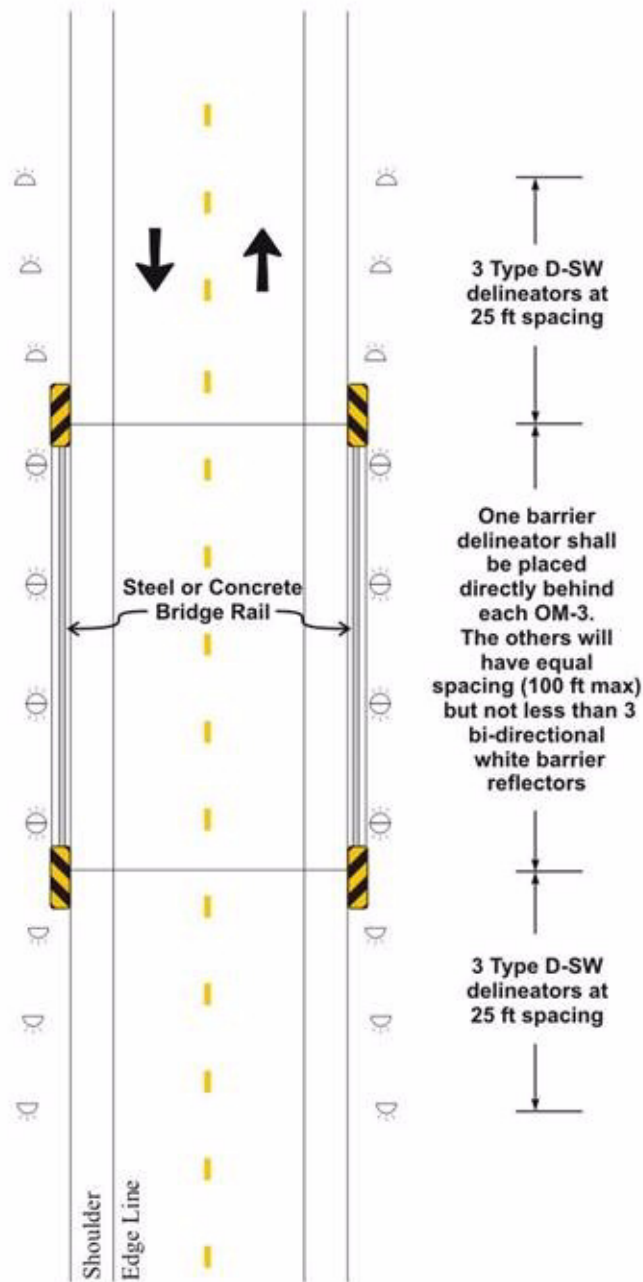

Figure 8-13. Two-Way, Two-Lane Road or Bridge with Guardrail and Reduced Width Approach



**Notes:**

- If used, there should be a minimum of 3 delineators or barrier reflectors on the bridge rail, with a maximum spacing of 100 ft between any 2 delineators or barrier reflectors.
- A minimum of 3 delineators should be used on the approach to the bridge rail.
- Barrier reflectors shall be bi-directional.
- Delineators on both sides of the bridge shall face approaching traffic.

LEGEND	
	D-SW or BR-W
	D-SW
	OM-Type 3

Figure 8-14. Two-Way, Two-Lane Bridge No Approach Rail (Bridgerail Only)

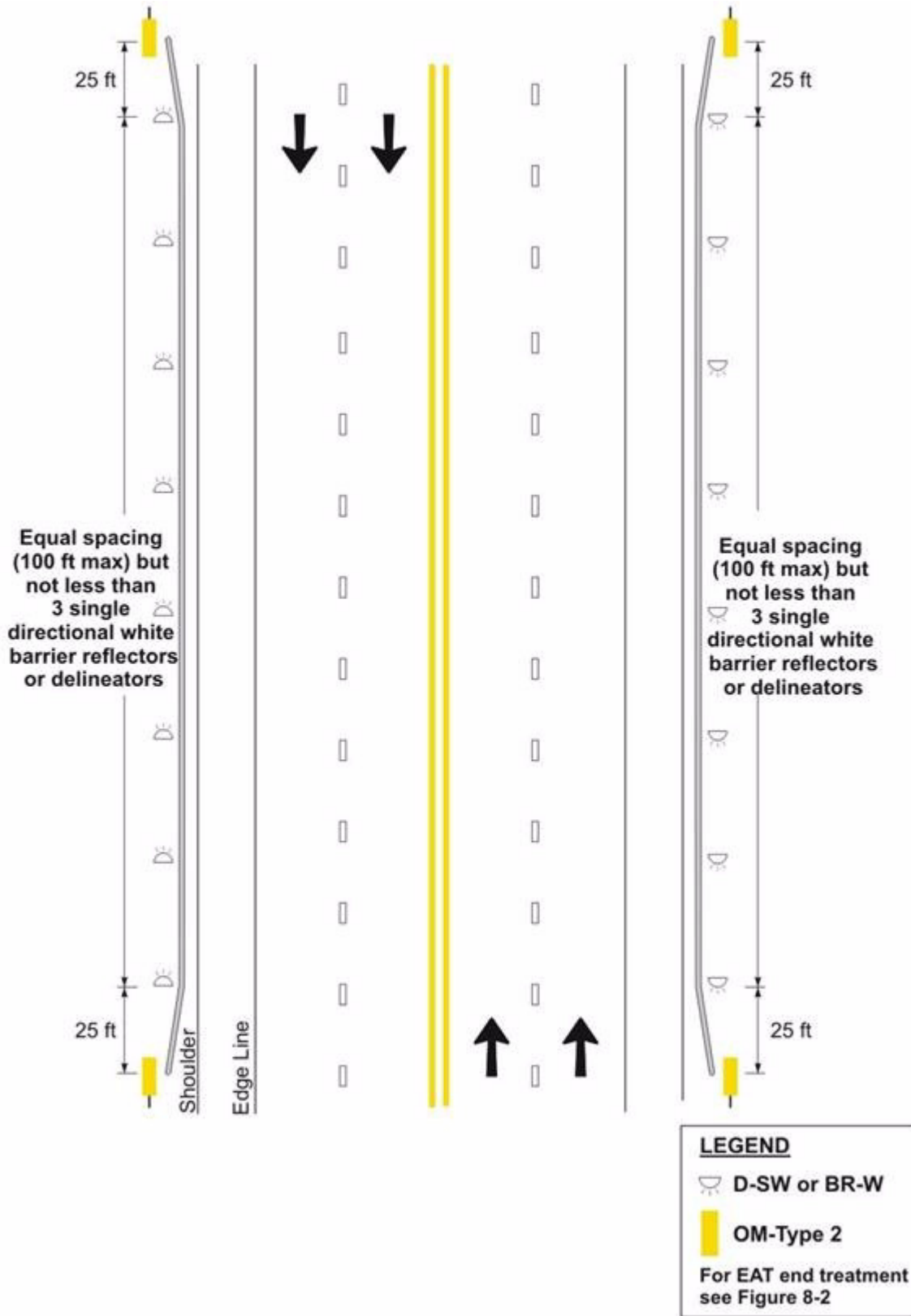

Figure 8-15. Multi-lane Undivided, Two-Way Road or Bridge with Guardrail



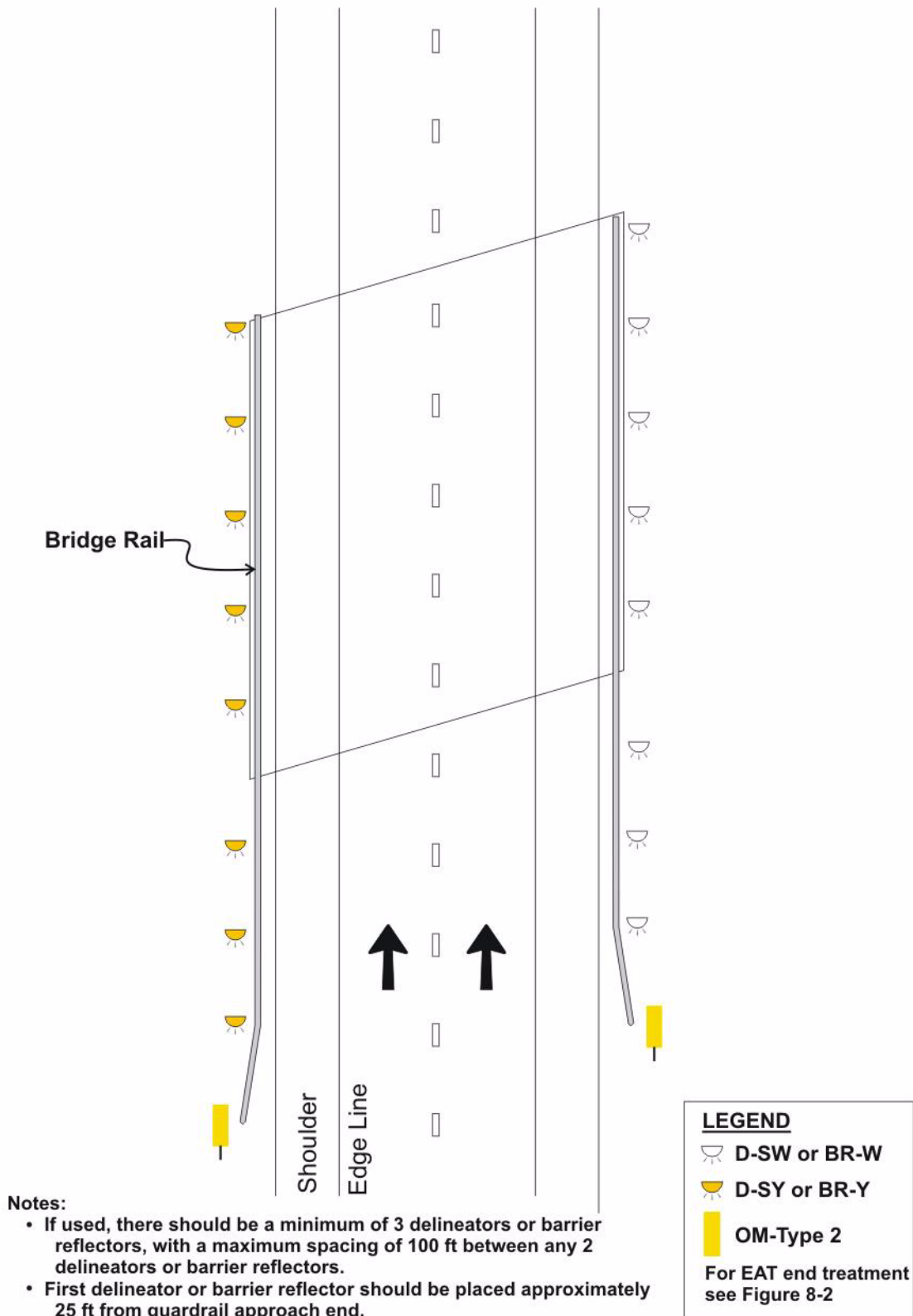

Figure 8-16. One-Way Road or Bridge (or Divided Highway) with Guardrail

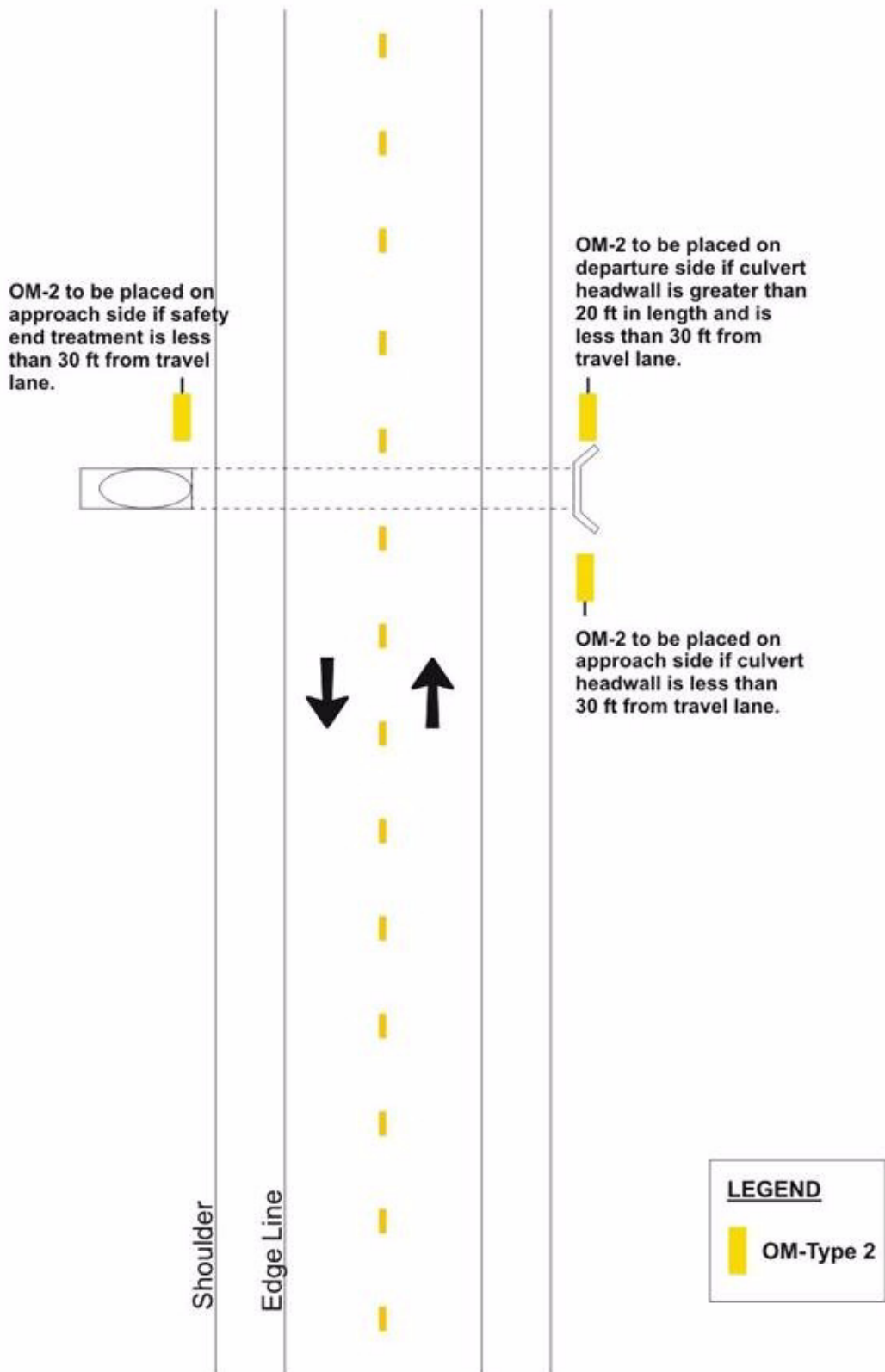

Figure 8-17. Two-Way Road over Culvert

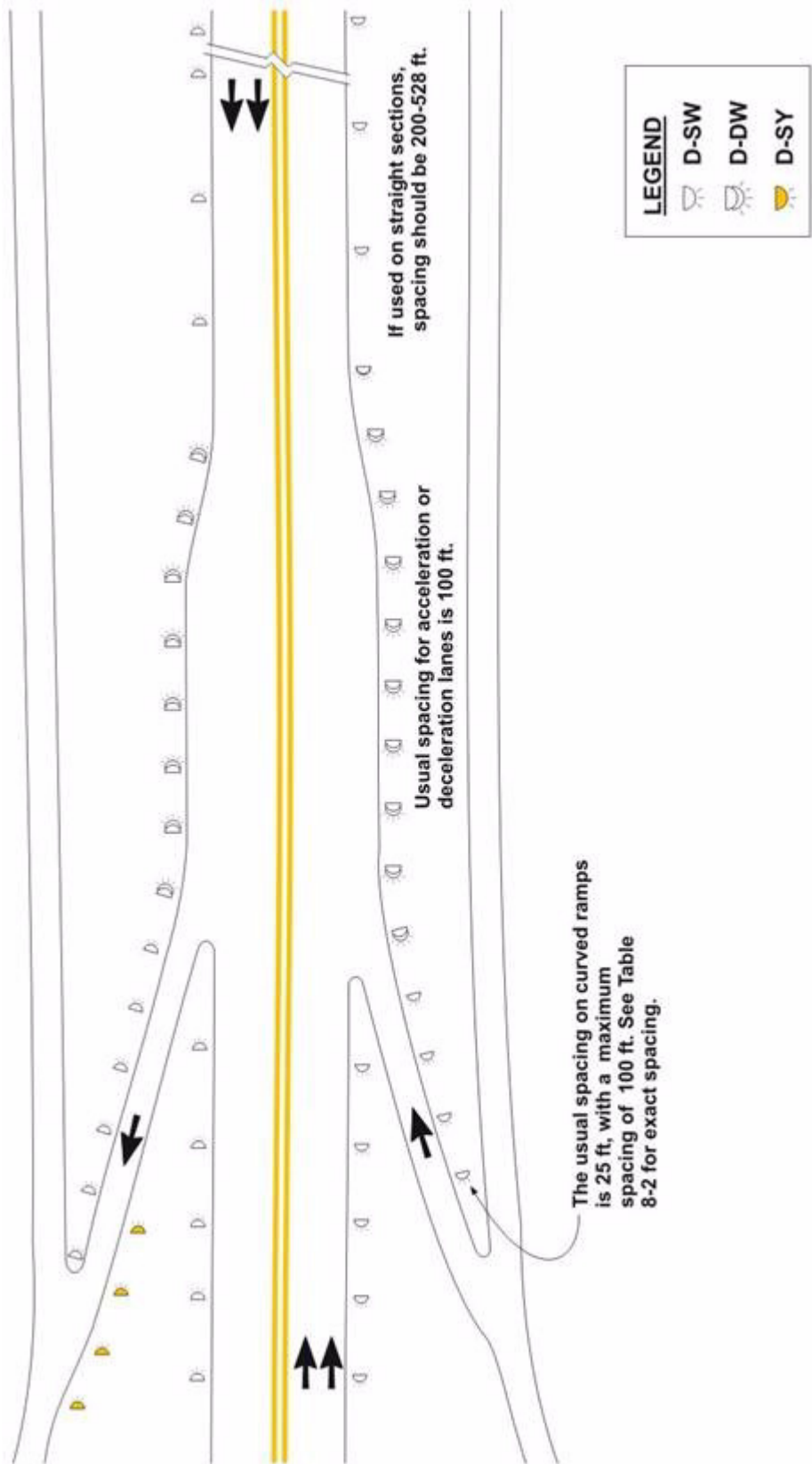

Figure 8-18. Freeway Delineation



# Chapter 9

## Mailboxes

### Contents:

[Section 1 — Overview](#)

[Section 2 — Types of Mailboxes and Installations](#)

[Section 3 — Mailbox Placement Considerations](#)

[Section 4 — Mailbox Hardware](#)

[Section 5 — Mailbox Installation](#)

[Section 6 — Mailbox Attachments](#)

[Section 7 — Mailbox Compliance](#)

## **Section 1**

### **Overview**

#### **Introduction**

Mailbox installation and placement present many challenges to sign crews. Mailboxes must be installed correctly and in an appropriate location. Sign crews are also responsible for dealing with mailboxes and mailbox supports that do not meet crashworthiness standards.

This chapter describes some of the basic issues related to mailbox installation, including the proper placement and installation of mailboxes and mailbox supports. Requirements for mailbox object markers and advice for dealing with non-compliant mailboxes and supports are also provided.

Standard sheets MB-06(1) and Guidelines MB-06(2) provide additional information about mailbox installation. These standard sheets are maintained by the Maintenance Division and are available on the Texas Department of Transportation web site. Type “CAD Standards” in the search field. The mailbox standard sheets can be found in the Maintenance Standards Plan Sheets in the TxDOT CAD Standard Plan Files.

## Section 2

### Types of Mailboxes and Installations

#### Introduction

For all residents whose mail is delivered from a road on the state highway system, TxDOT provides the necessary hardware to mount a mailbox that meets the size and weight requirements shown in Table 9-1. This hardware includes the post/support and the mounting bracket. TxDOT personnel also install the mailbox in the highway right-of-way.

#### Types of Mailboxes

There are three sizes of mailboxes as indicated in Table 9-1. The dimensions for the large mailbox represent the maximum size allowed for a mailbox.

**Table 9-1: Mailbox Sizes**

Size	Typical Dimensions (inches)			Maximum Weight (pounds)*
	Length	Width	Height	
Small	19 ½	6	7	5
Medium	22 ½	8	11 ½	7
Large	23 ½	11 ½	13 ½	10

\*Excluding molded plastic on a 4 x 4 post

Mailboxes shall be constructed of lightweight sheet metal or lightweight plastic material. Heavy steel, cast iron, or decorative mailboxes shall not be used on the state highway system. Field crews that are uncertain about whether a mailbox meets the criteria should contact the Maintenance Division. Section 7 in this chapter provides an example letter that can be provided to residents who have a mailbox that does not meet TxDOT criteria.

#### Types of Mailbox Installations

There are several types of mailbox installations:

- ◆ **Single mailbox installation:** One mailbox is installed on a single support.
- ◆ **Double mailbox installation:** Two mailboxes are installed on a single support.
- ◆ **Multiple mailbox installation:** Three to five mailboxes are installed on a single support. A multiple mount is normally used if there are three or more mailboxes at a single location. Five mailboxes can be installed only if all of them are the small size.

- ◆ **Neighbor Delivery and Collection Box Units:** NDCBUs, or community mailboxes, are a type of mailbox installation that serves a large number of residents, such as at an apartment complex or mobile home park. TxDOT is not responsible for the installation and maintenance of NDCBUs. This type of mailbox is installed by the Post Office. If possible, these mailbox units should be installed on low volume intersecting roadways or on private property. If it is essential for a NDCBU to be located on the right-of-way, TxDOT must be contacted to designate an acceptable location.



---

## Section 3

### Mailbox Placement Considerations

#### Introduction

Proper placement of mailbox supports is the key to reasonable ease of service by postal carriers and the safety of carriers and other motorists. There are three placement considerations for mailboxes: the height of the mailbox above the road or shoulder surface, the lateral offset from the edge of the road, and the longitudinal placement within a turnout or from an intersection.

#### Placement Adjacent to Paved (All-Weather) Surface

A new mailbox should not be installed unless it is accessible from a paved (all-weather) surface.

#### Longitudinal Placement

Longitudinal mailbox placement relates to the distance between a mailbox and: other mailboxes, the beginning or end of the mailbox turnout, and an intersection (if the mailbox installation is close to an intersection).

- ◆ **Distance between Individual Mailboxes and Mailbox Installations:** There should be a separation of approximately 2 ft between single and multiple mount mailboxes or between a single/double mailbox installation and a multiple mailbox installation. There should be approximately 4 ft between adjacent multiple mailbox installations. Figure 9-1 illustrates mailbox separation distances.
- ◆ **Road with Mailbox Turnout:** There should be a minimum of 14 ft from the mailbox to the beginning of the 8 ft wide all weather surface and a desirable distance of 6 ft from the last mailbox to the end of the 8 ft wide all weather surface. Figure 9-2 illustrates the longitudinal placement within a mailbox turnout.
- ◆ **Intersections:** Mailbox placement at intersections depends on whether the through road has a speed of less than 55 mph or 55 mph or greater. See Figures 9-3 and 9-4 for mailbox locations near a rural intersection for these two cases.

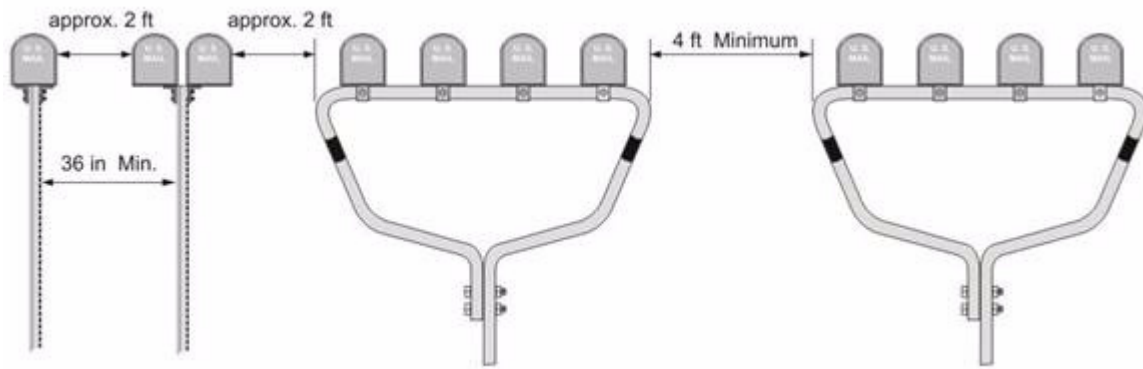

Figure 9-1. Approximate Distance between Mailbox Installations

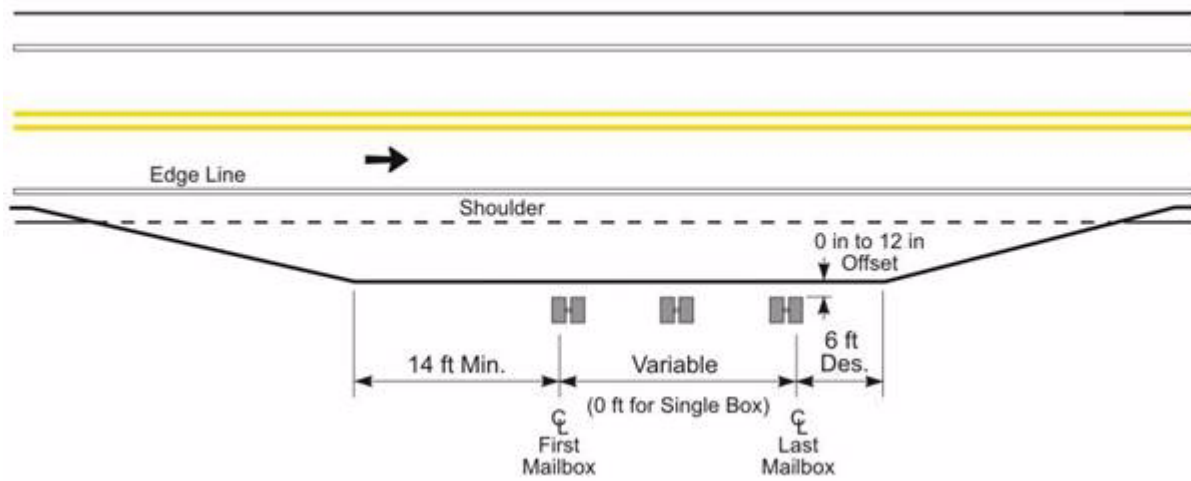

Figure 9-2. Mailbox Longitudinal Placement within a Mailbox Turnout

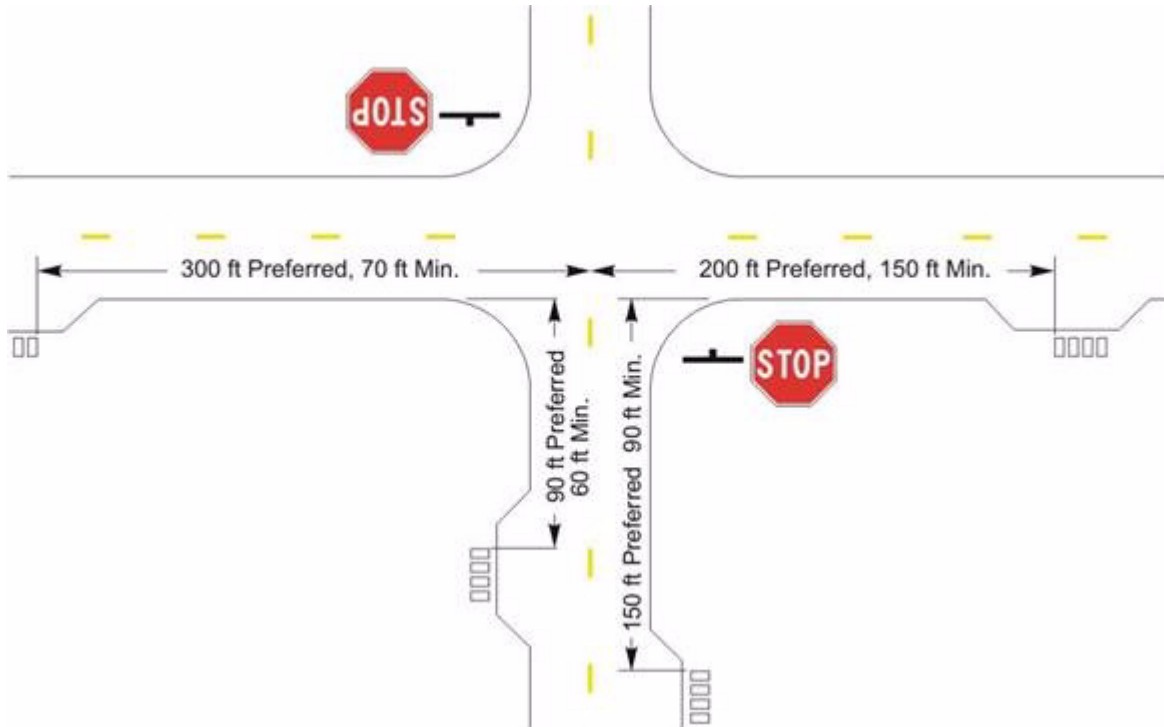

Figure 9-3. Mailbox Placement at Rural Locations: Through Highway Speed  $\geq$  55 mph

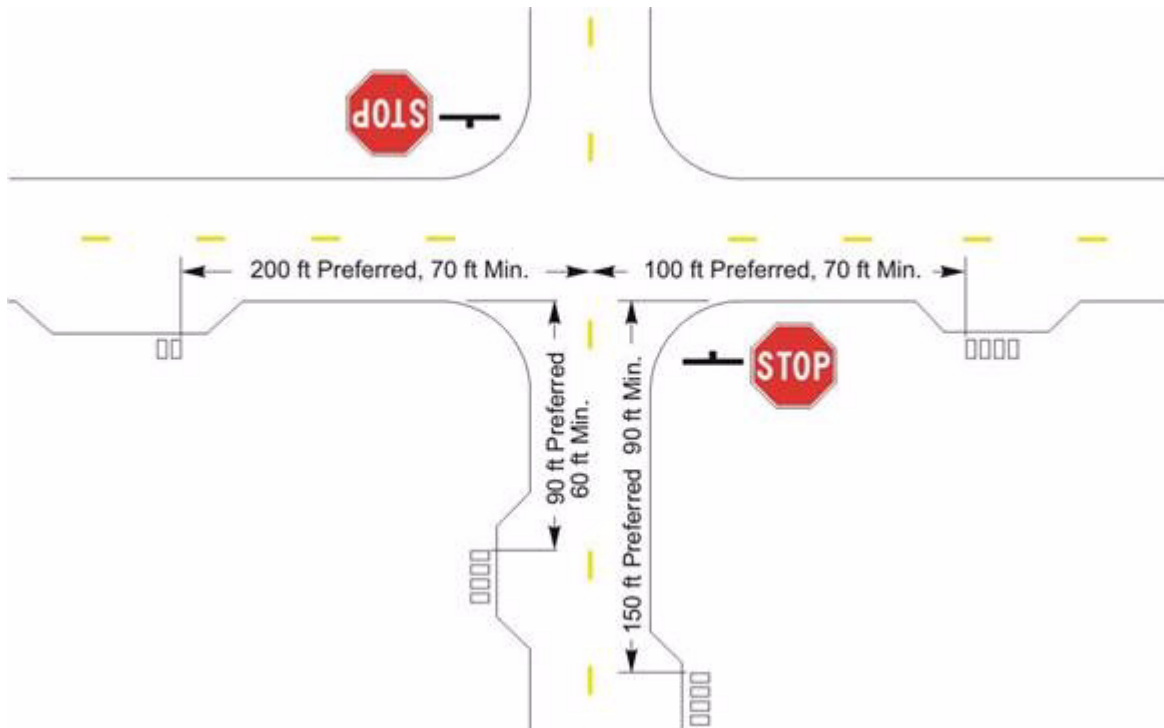

Figure 9-4. Mailbox Placement at Rural Locations: Through Highway Speed  $<$  55 mph

### Lateral Offset from Access Point

The lateral offset of the mailbox should be close enough to the shoulder or curb or other access location to allow the mail carrier to deliver mail from the mail vehicle. This distance is a function of the road cross section. Figures 9-5 and 9-6 illustrate the lateral placement of mailboxes. There are three conditions for lateral offset of mailboxes:

- ◆ **Delivery to front side:** Mailbox is installed so that mail can be accessed from an all-weather surface or terrain adjacent to the travel lane. See Figure 9-5.
- ◆ **Delivery to back side:** Mailbox is installed so that the mail can be accessed from an all-weather surface or terrain on the side of the mailbox away from the travel way. See Figure 9-6.
- ◆ **Delivery near right-of-way line:** Mailbox is installed near the right-of-way line and accessed from an all-terrain surface. This type of installation is associated with an NDCBU, which is installed by the Post Office.

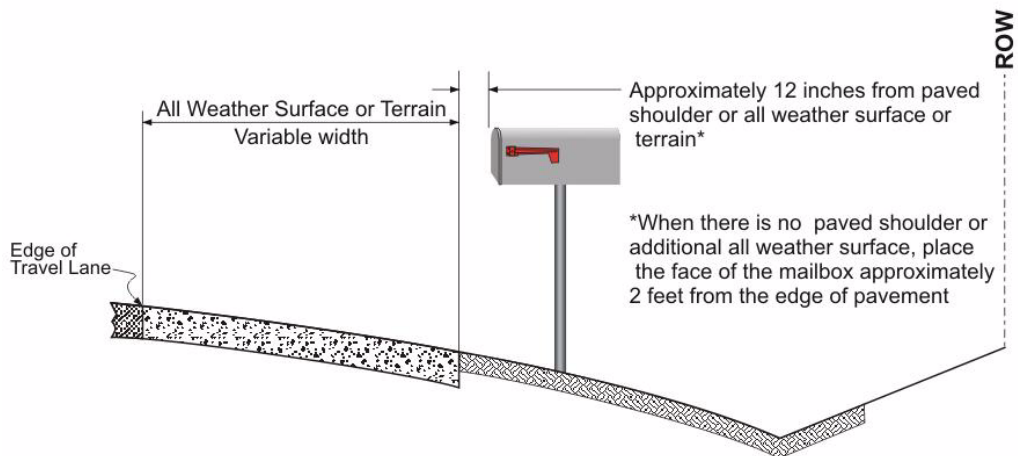

Figure 9-5. Lateral Placement for Delivery to the Front Side

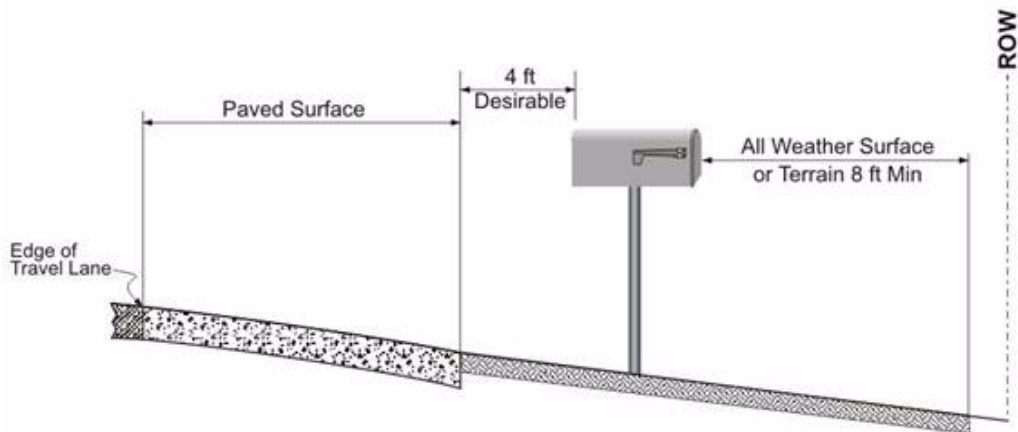

Figure 9-6. Lateral Placement for Delivery to the Back Side

### Height

The base of the mailbox should be installed at a typical height of 42 inches above the outside edge of the travel lane, shoulder, or turnout. Figure 9-7 illustrates the height of mailboxes.



Figure 9-7. Height of Mailbox

---

## Section 4

### Mailbox Hardware

#### Introduction

This section presents common information associated with mailbox hardware. The mailbox standards sheets (MB-06(1) and MB-06(2)) contain detailed information about mailbox hardware, DHT numbers, and installation guidelines.

#### Types of Supports

There are two general types of mailbox supports and specific hardware associated with each type of support:

- ◆ **Single Mailbox Support:** Either of these supports can be used to support a single mailbox.
  - **Thin-wall steel tube:** A 2 to 2½ inch diameter thin-wall steel tube. This type of post can be used with a small, medium, or large sized mailbox
  - **Wing channel post:** A 2 pound/ft wing channel post. This type of post can be used with a small or medium sized mailbox.
  - **Recycle Rubber Post:** A rubber post. This type of post is used only for a small size mailbox.
- ◆ **Double Mailbox Support:** This support is used to support two mailboxes on a single support.
  - **Thin wall steel tube:** A 2 to 2½ inch diameter thin wall steel tube.
  - **Wing channel post:** A 2 pound/ft wing channel post.
- ◆ **Multiple Support:** Either of these supports can be used for three or more mailboxes.
  - **Coat hanger support:** A 2 inch diameter thin-wall steel tube support frame that has a shape similar to an upside down coat hanger. See Figure 9-8.
  - **Constant radius support:** A 2 3/8 inch diameter white powder-coated semi-circular pipe with a constant radius. See Figure 9-9.

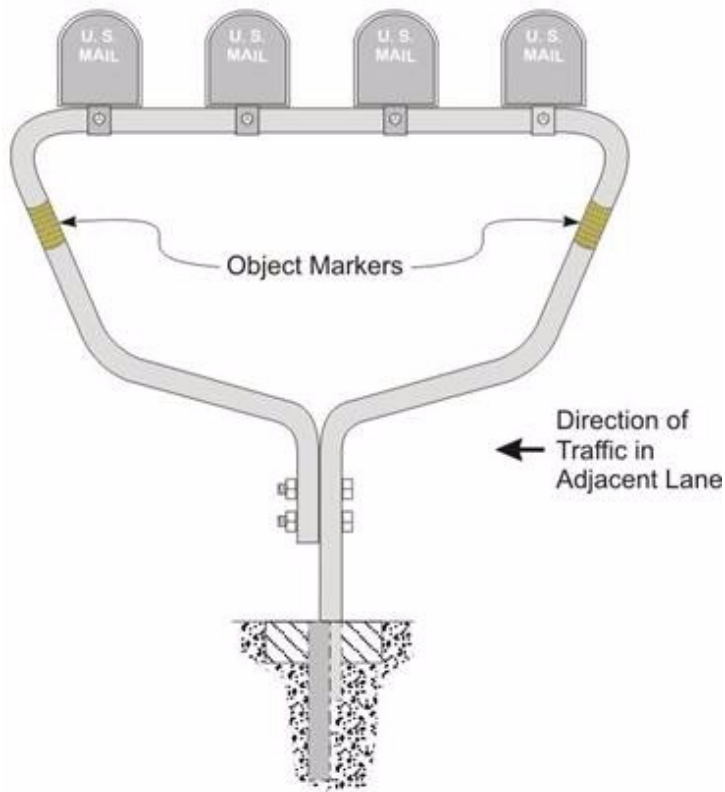

Figure 9-8. Coat Hanger Multiple Support

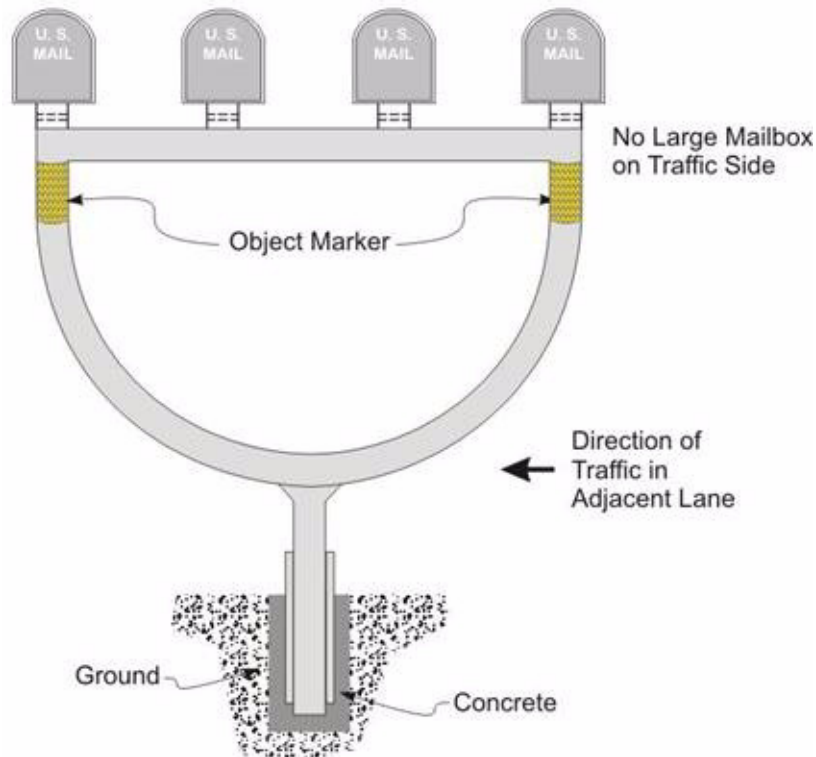

Figure 9-9. Constant Radius Multiple Support

### Types of Foundations

There are six types of foundations. Table 9-2 lists the foundations and indicates which type of foundation is used with each type of support.

**Table 9-2: Support and Foundation Combinations**

Type of Support	Type of Foundation					
	V-Loc	Wedge Anchor	Driven	Concrete	Embedded	Temporary
Thin-Wall Steel Tube	Type 1	Type 2	No	No	No	No
Thin-Wall Multiple (coathanger)	Type 1	No	No	No	No	No
Wing Channel	No	No	Type 3	No	No	No
Powdercoat Steel (constant radius)	No	No	No	Type 4	No	No
Recycled Rubber	No	No	No	Type 4	No	No
4 x 4 Wood	No	No	No	No	Type 5	No
Plastic Drum	No	No	No	No	No	Type 6

Figure 9-10 illustrates the orientation of the supports/anchors relative to the direction of traffic. Where a wedge is used, it is installed on the side of the support nearest the direction of traffic.

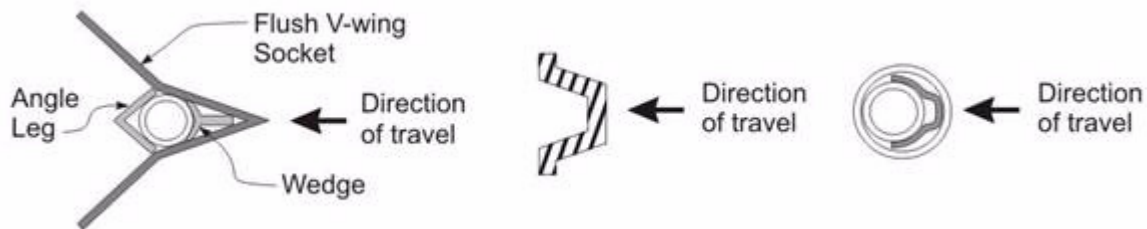

*Figure 9-10. Orientation of Supports/Anchors for Single/Double Mailbox Installations*



## Mailbox Bracket

The TxDOT universal mailbox bracket provides a single bracket that can be used to mount a small, medium, or large mailbox to a single or multiple support. Figure 9-11 illustrates the basic mailbox bracket. The extensions are used only with a medium or large mailbox. Bolts with a 3/8 inch diameter should be used to provide a tighter fit and prevent the mailbox from rocking. Figures 9-12 to 9-15 illustrate the attachment of the bracket to mailbox supports.

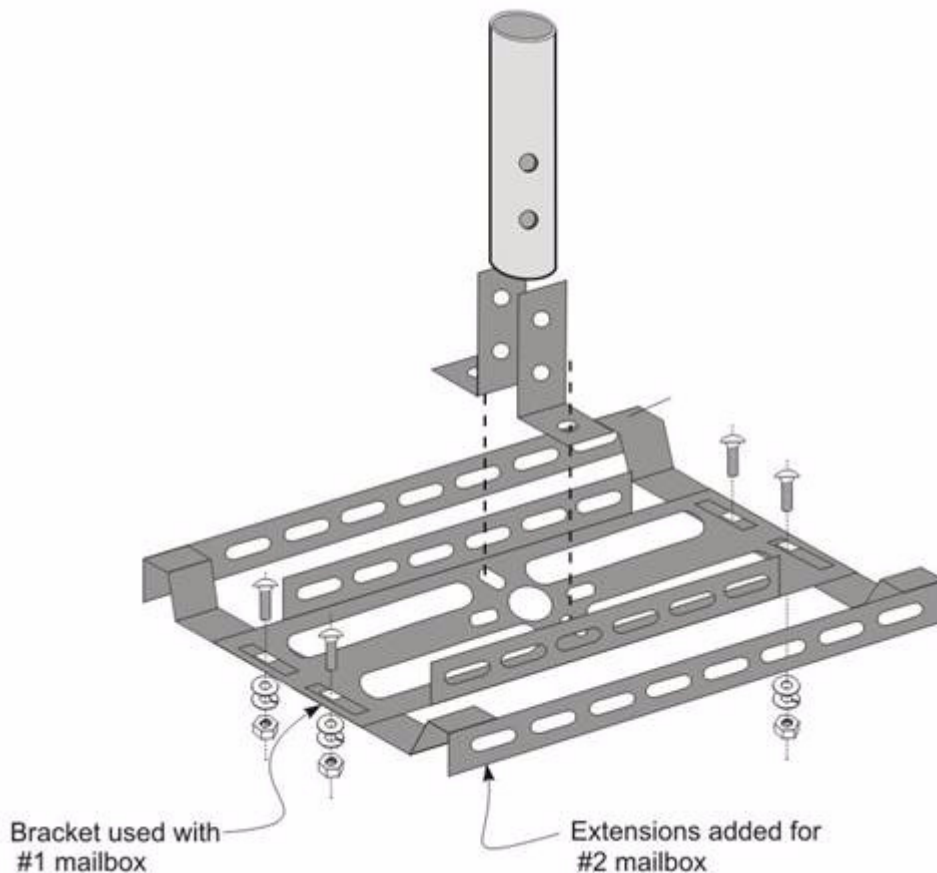

Figure 9-11. Mailbox Bracket (shown upside down)

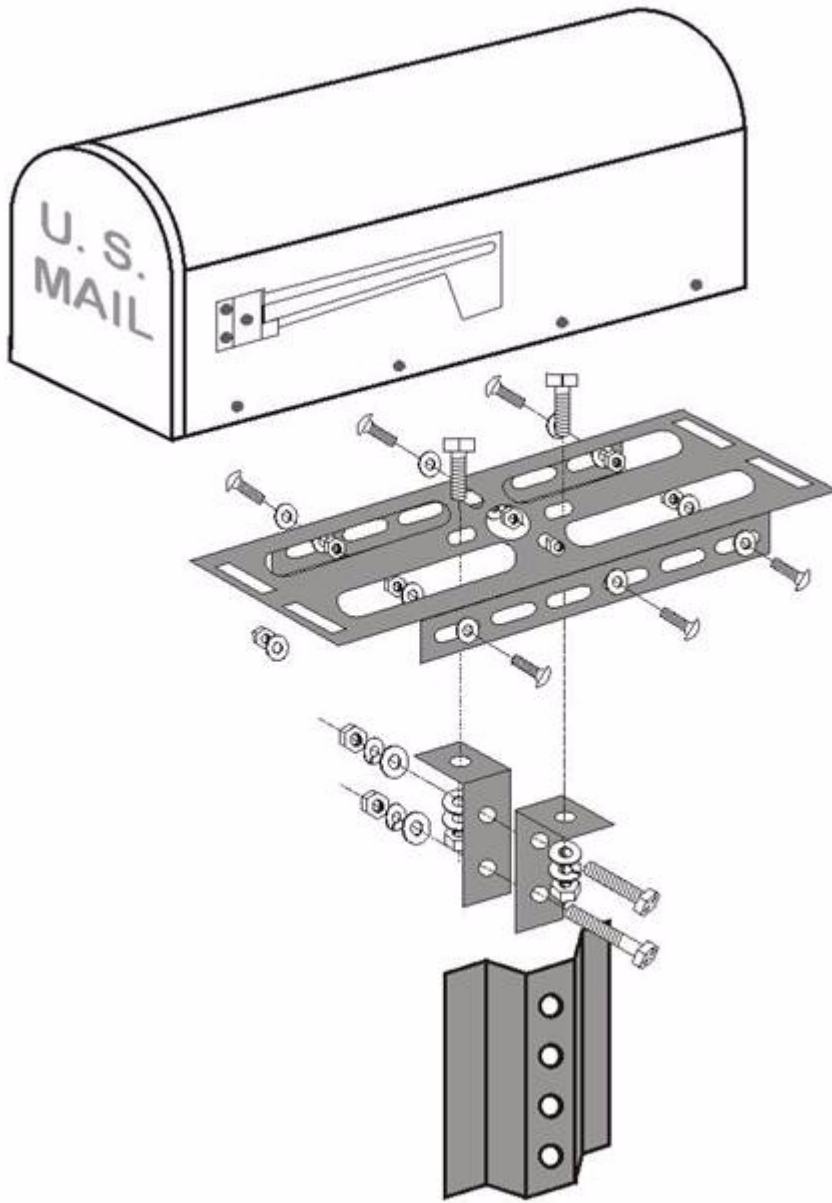

Figure 9-12. Attaching the Bracket to a Single Support

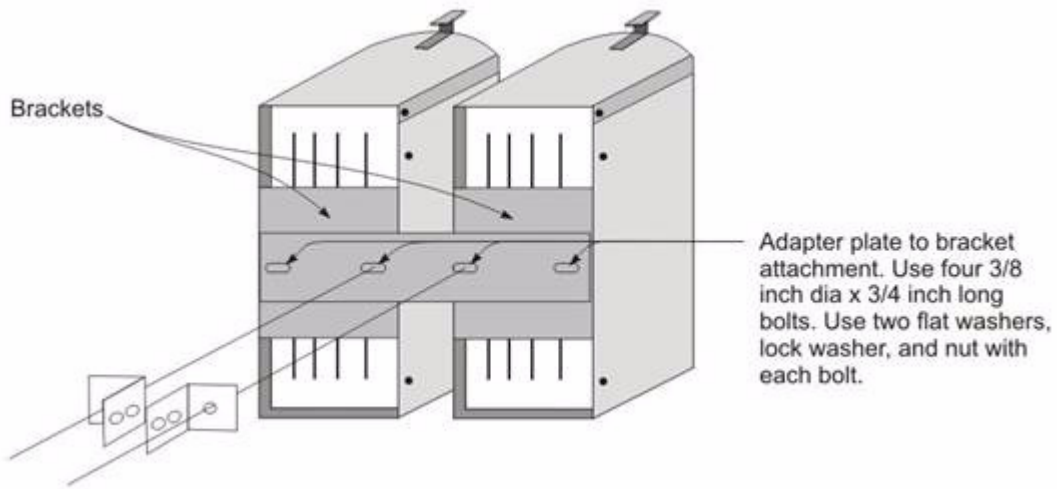

Figure 9-13. Use of the Adapter Plate for a Double Mailbox Installation

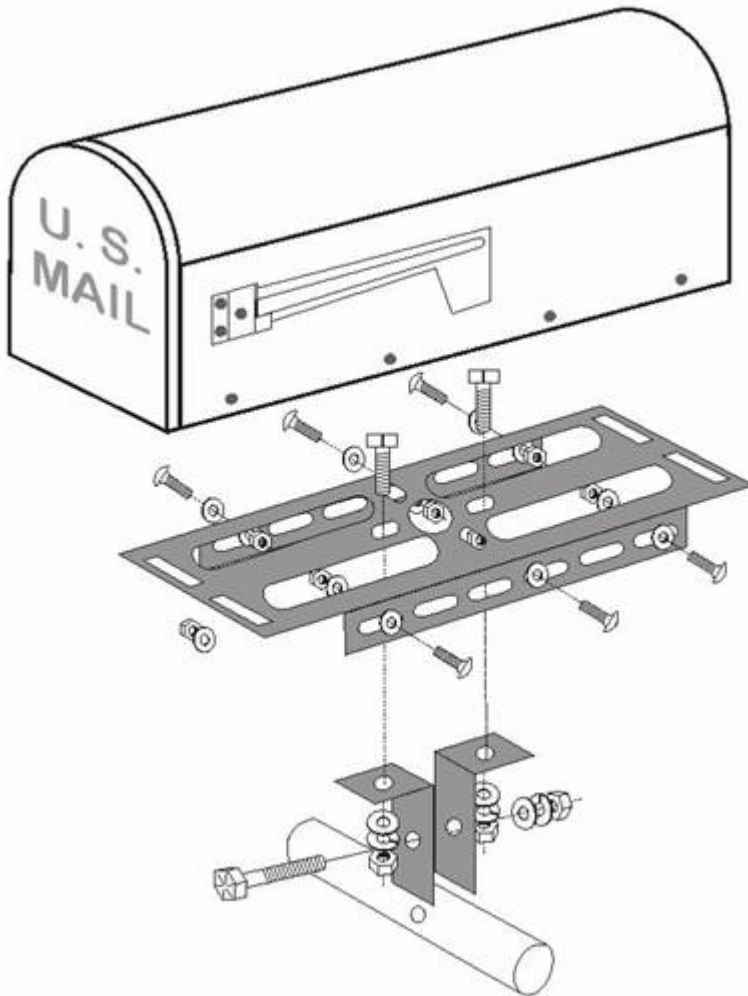

Figure 9-14. Attaching the Bracket to the Multiple Support

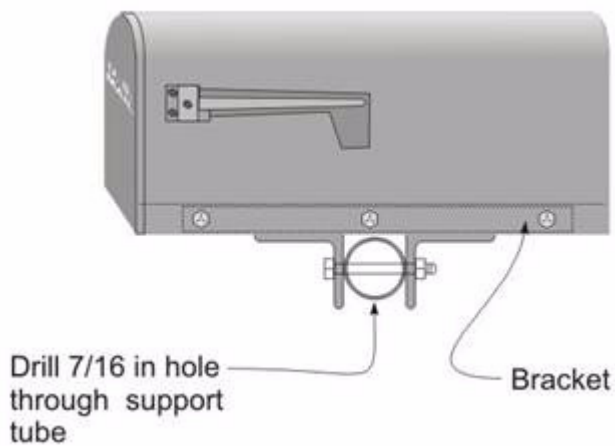

Figure 9-15. Bolting the Bracket to a Multiple Support Tube

The following list of tasks provides step-by-step instructions for putting the bracket together:

- ◆ Attach extension bracket (if required):
  - For a small mailbox, no extension brackets are used.
  - For a medium mailbox, an extension bracket is used on one side only.
  - For a large mailbox, extension brackets are installed on each side.
- ◆ Bolt angle brackets to bottom of mailbox bracket:
  - See Figures 9-12 and 9-13 for orientation with a single or double mailbox support.
  - See Figures 9-14 and 9-15 for orientation with a multiple support.
- ◆ Bolt bracket to mailbox.
- ◆ Bolt assembled bracket/mailbox to support.

## Section 5 Mailbox Installation

### Single Mailbox Installation

Figure 9-16 illustrates the installation of a single mailbox on a wing channel support.

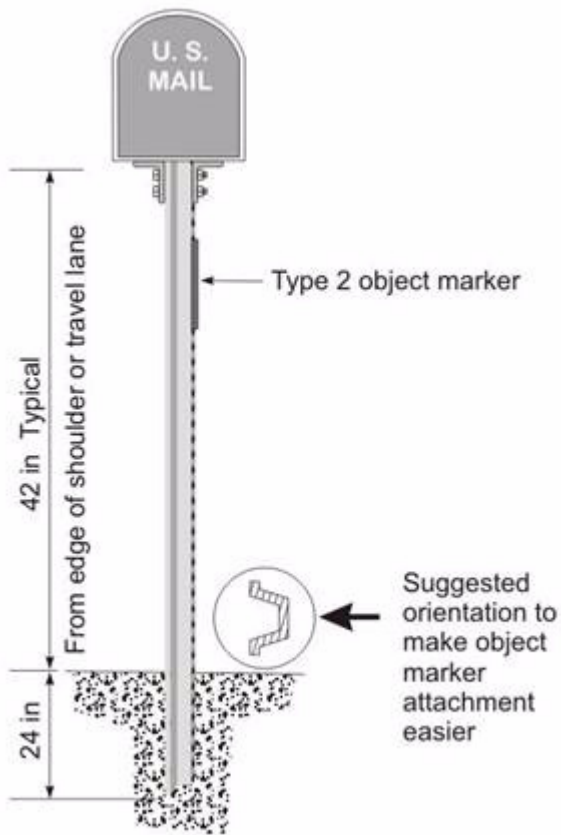

Figure 9-16. Installation of Single Mailbox on Wing Channel Support

### Double Mailbox Installation

Figure 9-17 illustrates the installation of a double mailbox on a wing channel support.

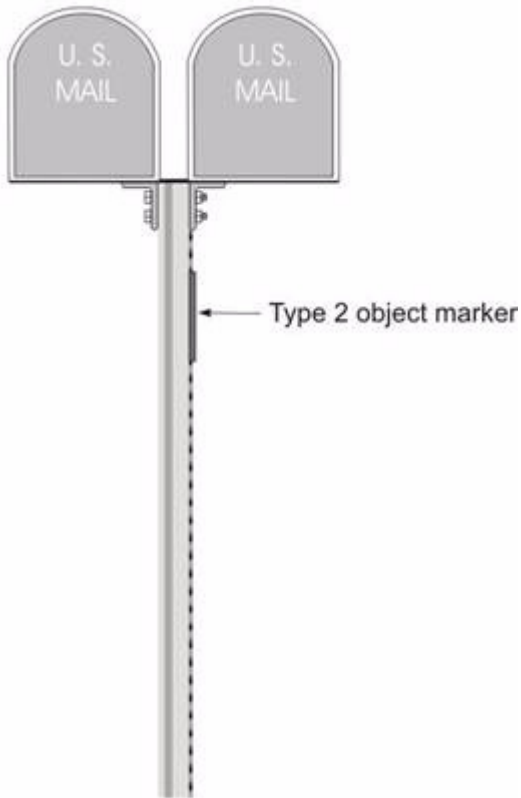

Figure 9-17. Installation of a Double Mailbox on a Wing Channel Support

### Multiple Mailbox Support

Figure 9-18 illustrates the installation of a multiple mailbox support.

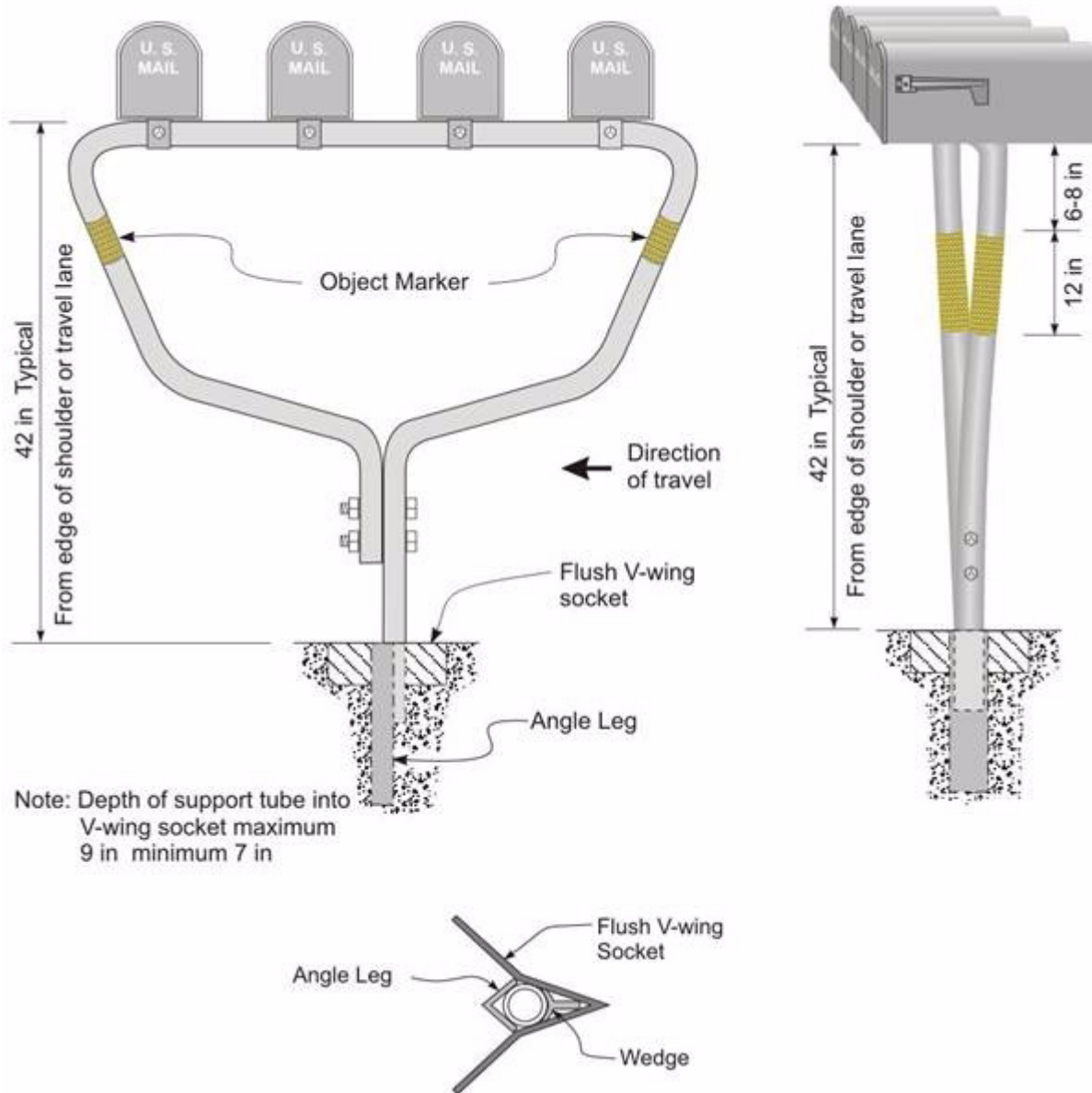

Figure 9-18. Installation of a Multiple Mailbox Support

## Section 6

### Mailbox Attachments

#### Introduction

Several items can be attached to a mailbox or mailbox support, including an object marker, emergency location number, and newspaper receptacle.

#### Object Markers on Mailbox Supports

On two-lane, two-way roads, object markers should be placed on both sides of the mailbox support. In other cases, mailboxes should have a yellow Type 2 object marker facing traffic on the near side of the roadway. The Type 2 object marker can be either of the following:

- ◆ A 6 inch wide by 12 inch tall rectangular unit with reflective sheeting bolted or affixed to the support.
- ◆ A 12 inch strip of sheeting wrapped around the support post.

The top of the Type 2 object marker should be 6-8 inches below the bottom of the mailbox. Figures 9-19 and 9-20 illustrate the use of the object marker on mailbox supports.

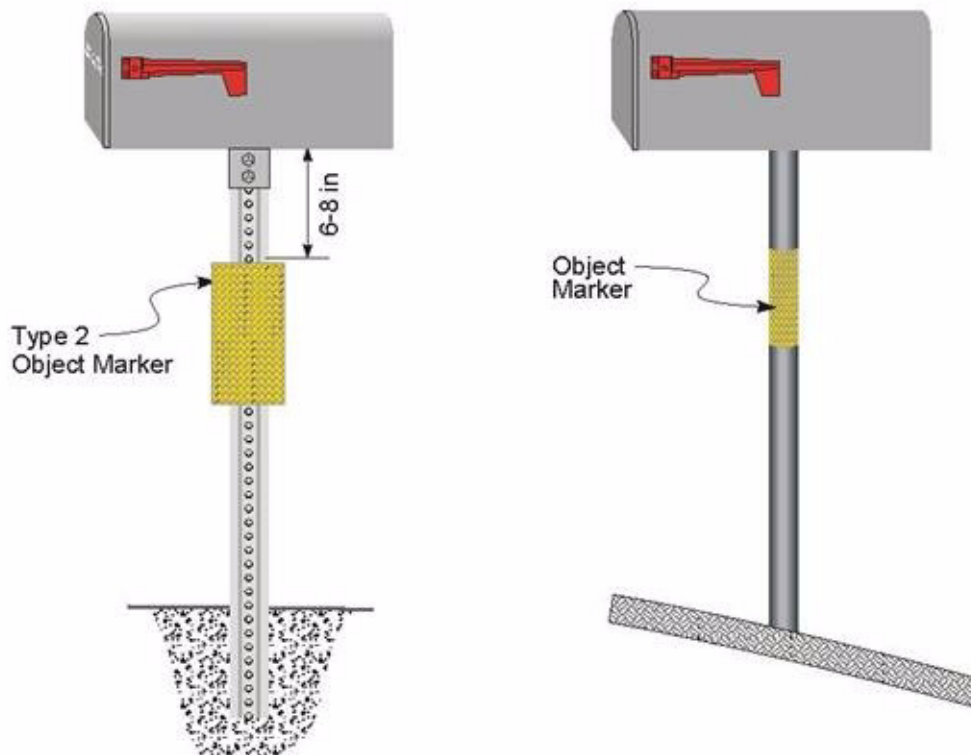

Figure 9-19. Type 2 Object Marker Installations



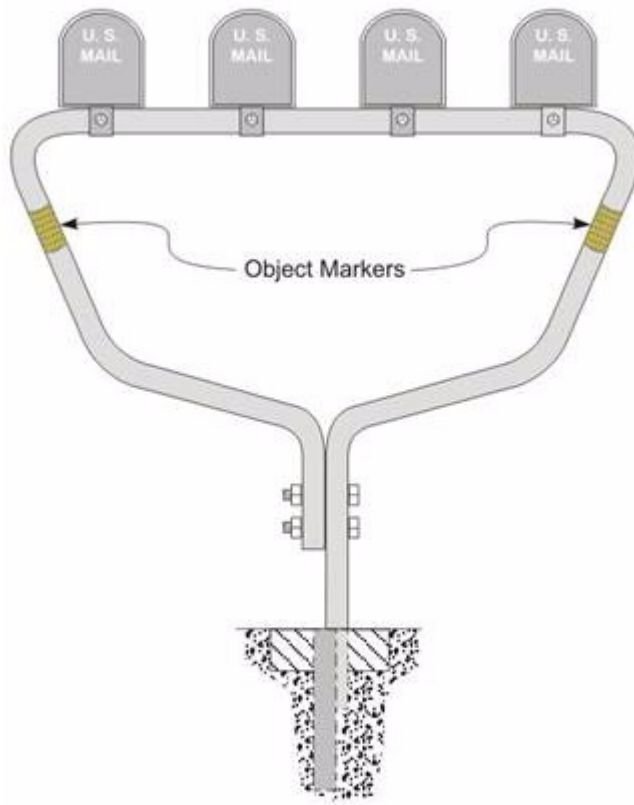

Figure 9-20. Type 2 Object Marker Installation (Sheeting Wrap on Multiple Post)

## Emergency Location Number

An Emergency Location Number can be placed on a mailbox installation to indicate the address. The number is the street address for the mailbox. The preferred location is on the mailbox. The alternative location is in place of the Type 2 object marker on the support. When used in place of the object marker, the Emergency Location Number shall be black numbers on a yellow Type 2 object marker panel. Figure 9-21 illustrates the Emergency Location Number.

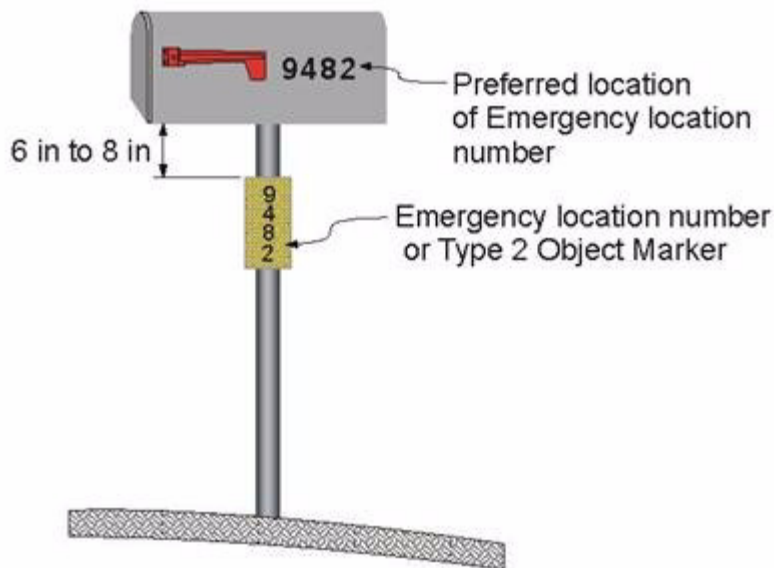

Figure 9-21. Placement of Emergency Location Number

## Newspaper Receptacle

A lightweight receptacle for newspaper delivery can be attached to a mailbox support if the receptacle meets all of the following conditions:

- ◆ It does not touch any mailboxes.
- ◆ It is mounted below the mailbox and above the object marker.
- ◆ It does not extend beyond the front of the mailbox.
- ◆ It does not display any advertising other than the name of the newspaper.
- ◆ It does not present a hazard to traffic or to mail delivery.

The newspaper receptacle is placed on the downstream side of the post so that an object marker can be placed on the side facing traffic. Figure 9-22 illustrates newspaper receptacle placement.

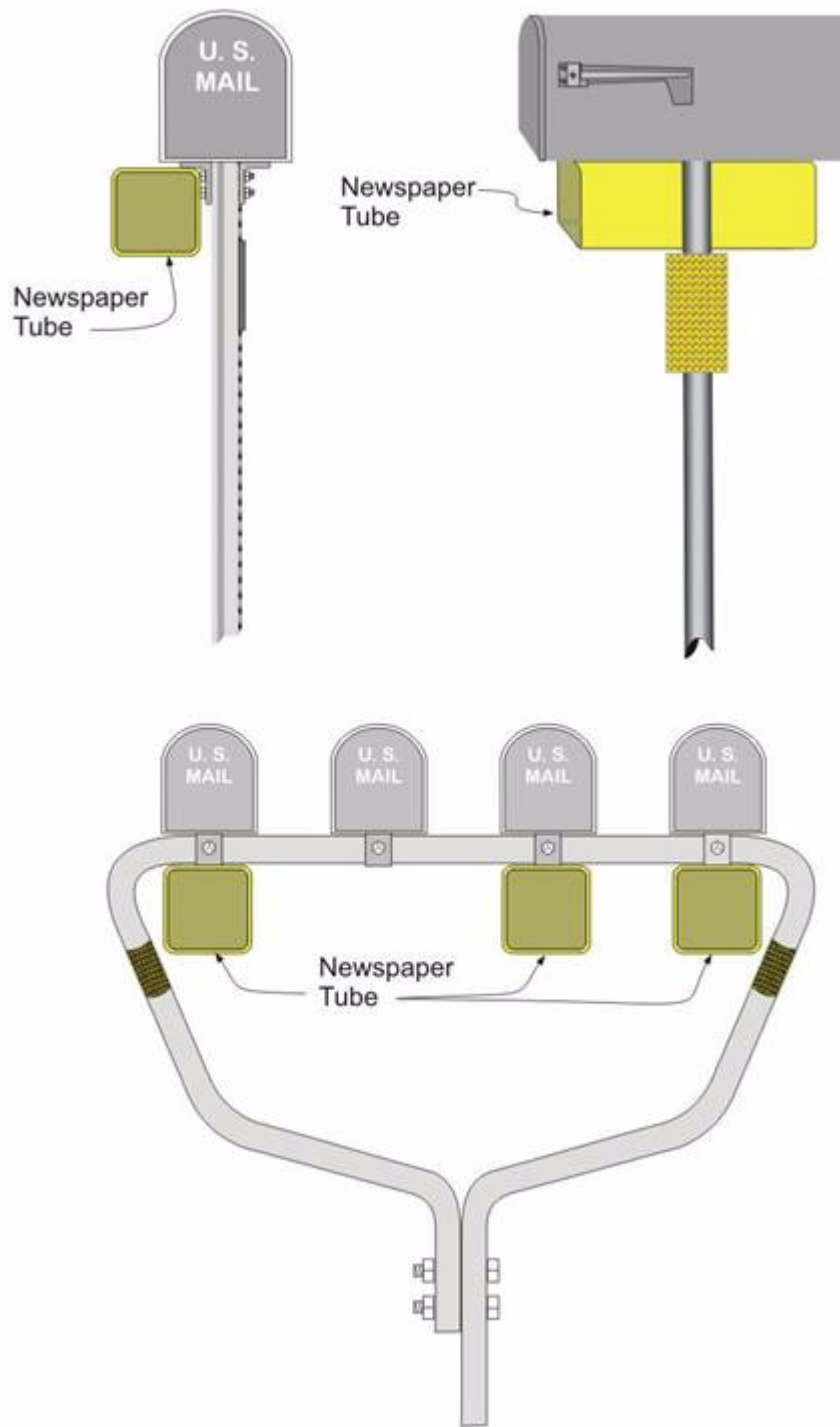

Figure 9-22. Newspaper Receptacle Placement

## Section 7

### Mailbox Compliance

#### Introduction

Mailbox installations involve the occasional unique challenge. Non-complying mailbox installations is one of the most common challenges.

#### Example Letter to Box Owners

Figure 9-23 presents a standard TxDOT form letter that can be presented to owners of mailboxes and/or mailbox supports that do not conform to TxDOT safety standards.



Form 2050  
(Rev. 06/09)  
Page 1 of 1

Date:

Resident:

The Texas Department of Transportation (TxDOT) is responsible for providing a safe and efficient transportation system for the traveling public. In order to create a safe environment TxDOT has developed and crash tested various break away supports for signs, illumination poles, and mailbox supports located on the state right of way. Based on these tests TxDOT has determined that all mailboxes and mailbox supports located in the state right of way must meet a minimum safety standard.

TxDOT has determined that your mailbox is located in the state right of way and that it does not meet the minimum safety requirements. Therefore, we request that you contact the TxDOT representative listed below to make arrangements to remove your mailbox and/or mailbox support as soon as possible.

\_\_\_\_\_  
TxDOT REPRESENTATIVE

\_\_\_\_\_  
TxDOT TELEPHONE NUMBER

\_\_\_\_\_  
TxDOT DISTRICT

\_\_\_\_\_  
TxDOT ADDRESS

\_\_\_\_\_  
COUNTY

\_\_\_\_\_  
CITY

\_\_\_\_\_  
STATE ZIP

If you supply TxDOT with an approved mailbox within 21 days of this letter we will reinstall your mailbox with a properly designed support pole that meets the safety requirements at no cost to you. If you do not remove your mailbox or contact us about replacement within 21 days of this letter, TxDOT will relocate your existing mailbox to the right of way line.

*Figure 9-23. Standard Letter for Non-Compliant Mailbox*